



FMC650

Professional tracker with CAN data
reading feature

Quick Manual v1.4

CONTENT

Know your device.....	3
Pinout	4
Wiring scheme.....	5
Set up your device	6
PC Connection (Windows).....	7
How to install USB drivers (Windows)	7
Configuration (Windows)	8
Quick SMS configuration.....	10
Mounting recommendations.....	12
Basic characteristics	13
LED indications.....	13
Electrical characteristics.....	16
Safety information	18
Certification and Approvals	19
Warranty	20
Warranty disclaimer	20

KNOW YOUR DEVICE

TOP VIEW

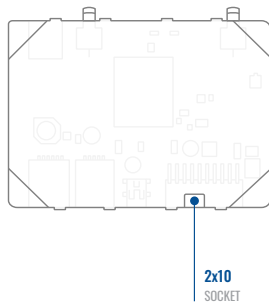

BOTTOM VIEW (WITHOUT COVER)

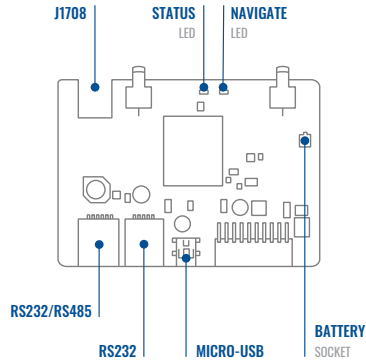

TOP VIEW (WITHOUT COVER)

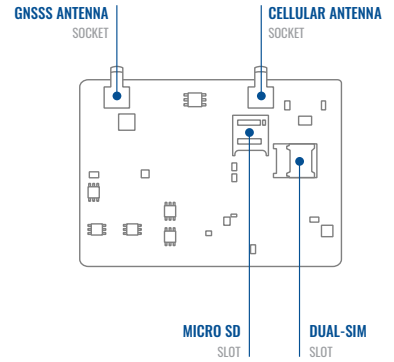

PINOUT

PIN NUMBER	PIN NAME	DESCRIPTION
1	GND (-)	Ground
2	CAN 1L	SAE J1939 CAN interface Low channel 1
3	1WIRE POWER	Power supply pin for Dallas 1-Wire® devices
4	DIN4	Digital input, channel 1
5	DIN2	Digital input, channel 2
6	CAN 2L	SAE J1939 CAN interface Low channel 2
7	AIN2	Analog input, channel 2. Input range: 0-30V/0-10V DC
8	DOUT3	Digital output. Open collector output
9	DOUT2	Digital output. Open collector output
10	AIN3	Analog input, channel 3. Input range: 0-30V/0-10V DC
11	VCC (+)	Power supply (+8-32 V DC)
12	CAN 1H	SAE J1939 CAN interface High channel 1
13	1WIRE DATA	Data channel for Dallas 1-Wire® devices
14	DIN3	Digital input, channel 3
15	IGN (DIN1)	Digital input, channel 1. DEDICATED FOR IGNITION INPUT

16	CAN 2H	SAE J1939 CAN interface High channel 2
17	AIN1	Analog input, channel 1. Input range: 0-30V/0-10V DC
18	DOUT4/ AIN4	Digital output. Open collector output OR Analog input, channel 4. Input range: 0-30V/0-10V DC
19	DOUT1	Digital output. Open collector output
20	K-Line	K-LINE interface for online Tachograph Vehicle Data transfer

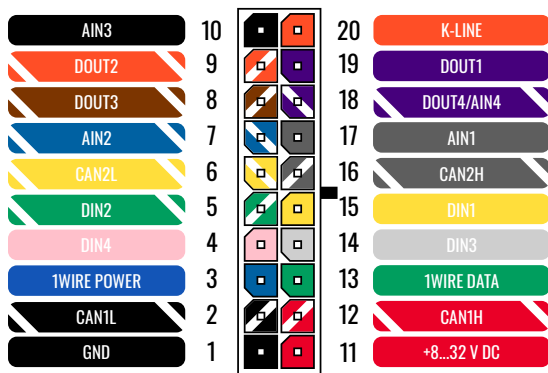

FMC650 2x10 socket pinout

WIRING SCHEME

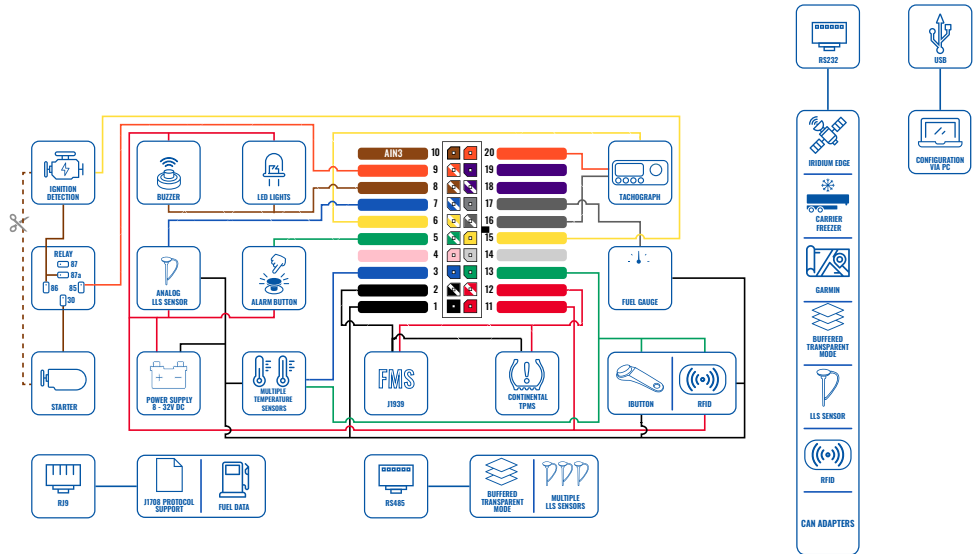

SET UP YOUR DEVICE

HOW TO INSERT MICRO-SIM CARD AND CONNECT THE BATTERY

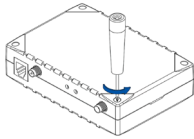

1 UNSCREW SCREWS

Unscrew 4 screws counterclockwise that are located on the **bottom** of the device.

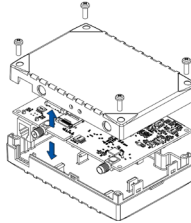

2 COVER REMOVAL

Remove the **cover**

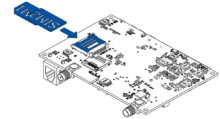

3 SIM CARD INSERT

Insert SIM card as shown with PIN request disabled or read [Security info](#)¹ how to enter it later in [Teltonika Configurator](#)². Make sure that SIM card cut-off corner is pointing forward to slot. SIM slot 1 is closer to PCB, SIM slot 2 is the upper one.

¹ wiki.teltonika.lt/view/FMC650_Security_info

² wiki.teltonika.lt/view/Teltonika_Configurator

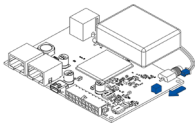

4 BATTERY CONNECTION

Connect **battery** as shown to device.

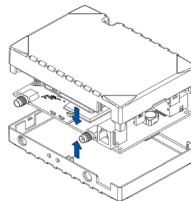

5 ATTACHING COVER BACK

After configuration, see "PC Connection (Windows)", attach device cover back.

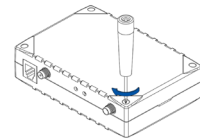

6 DEVICE IS READY

Screw in all screws. Device is ready to be mounted.

PC CONNECTION (WINDOWS)

1. Power-up FMC650 with **DC voltage (8 – 32 V)** power supply using **supplied power cable**. LED's should start blinking, see "**LED indications**".
2. Connect device to computer using **Micro-USB cable** or Bluetooth connection:
 - Using Mini-USB cable
 - You will need to install USB drivers, see "**How to install USB drivers (Windows)**"
3. You are now ready to use the device on your computer.

¹wiki.teltonika-gps.com/view/FMC650_LED_status

²Page 7, "How to install USB drivers"

HOW TO INSTALL USB DRIVERS (WINDOWS)

1. Please download COM port drivers from [here](#)¹.
2. Extract and run **TeltonikaCOMDriver.exe**.
3. Click **Next** in driver installation window.
4. In the following window click **Install** button.
5. Setup will continue installing the driver and eventually the confirmation window will appear. Click **Finish** to complete the setup.

¹teltonika-gps.com/downloads/en/FMC650/TeltonikaCOMDriver.zip

CONFIGURATION (WINDOWS)

At first FMC650 device will have default factory settings set. These settings should be changed according to the users needs. Main configuration can be performed via [Teltonika Configurator](#)¹ software. Get the latest **Configurator** version from [here](#)². Configurator operates on **Microsoft Windows OS** and uses prerequisite **MS .NET Framework**. Make sure you have the correct version installed.

¹ wiki.teltonika-gps.com/view/Teltonika_Configurator

² wiki.teltonika-gps.com/view/Teltonika_Configurator_versions

MS .NET REQUIREMENTS

Operating system	MS .NET Framework version	Version	Links
Windows Vista Windows 7 Windows 8.1 Windows 10	MS .NET Framework 4.6.2	32 and 64 bit	www.microsoft.com ¹

¹ dotnet.microsoft.com/en-us/download/dotnet-framework/net462

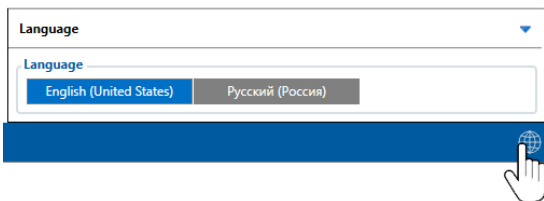

Downloaded Configurator will be in compressed archive. Extract it and launch Configurator.exe. After launch software language can be changed by clicking  in the right bottom corner.





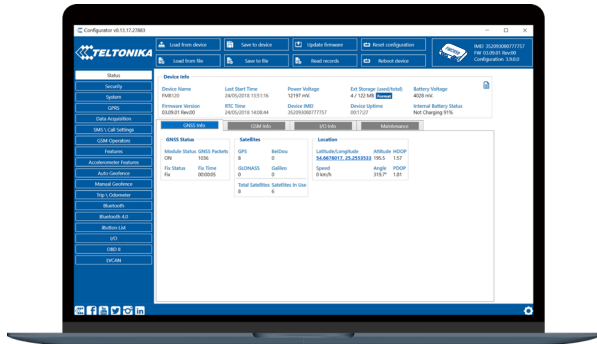





Configuration process begins by pressing on connected device.



After connection to Configurator **Status window** will be displayed.

Various **Status window**¹ tabs display information about **GNSS**², **GSM**³, **I/O**⁴, **Maintenance**⁵ and etc. FMC650 has one user editable profile, which can be loaded and saved to the device. After any modification of configuration the changes need to be saved to device using **Save to device** button. Main buttons offer following functionality:

-  **Load from device** – loads configuration from device.
-  **Save to device** – saves configuration to device.
-  **Load from file** – loads configuration from file.
-  **Save to file** – saves configuration to file.
-  **Update firmware** – updates firmware on device.
-  **Read records** – reads records from the device.
-  **Reboot device** – restarts device.
-  **Reset configuration** – sets device configuration to default.

Most important configurator section is **GPRS** – where all your server and **GPRS settings**⁶ can be configured and **Data Acquisition**⁷ – where data acquiring parameters can be configured. More details about FMC650 configuration using Configurator can be found in our **Wiki**⁸.

¹ wiki.teltonika-gps.com/view/FMC650_Status_info

² wiki.teltonika-gps.com/view/FMC650_Status_info#GNSS_Info

³ wiki.teltonika-gps.com/view/FMC6501_Status_info#GSM_Info

⁴ wiki.teltonika-gps.com/view/FMC650_Status_info#I2FO_Info

⁵ wiki.teltonika-gps.com/view/FMC650_Status_info#Maintenance

⁶ wiki.teltonika-gps.com/index.php?title=FMC650_GPRS_settings

⁷ wiki.teltonika-gps.com/index.php?title=FMC650_Data_acquisition_settings

⁸ wiki.teltonika-gps.com/index.php?title=FMC650_Configuration

QUICK SMS CONFIGURATION

Default configuration has optimal parameters present to ensure best performance of track quality and data usage.

Quickly set up your device by sending this SMS command to it:

```
« setparam 2001:APN;2002:APN_username;2003:APN_password;2004:Domain;2005:Port;2006:0»
```

1

2

3

4

5

6

Note: Before SMS text, two space symbols should be inserted.

GPRS SETTINGS:

- 1 2001 – APN
- 2 2002 – APN username (if there are no APN username, empty field should be left)
- 3 2003 – APN password (if there are no APN password, empty field should be left)

SERVER SETTINGS:

- 4 2004 – Domain
- 5 2005 – Port
- 6 2006 – Data sending protocol (0 – TCP, 1 – UDP)

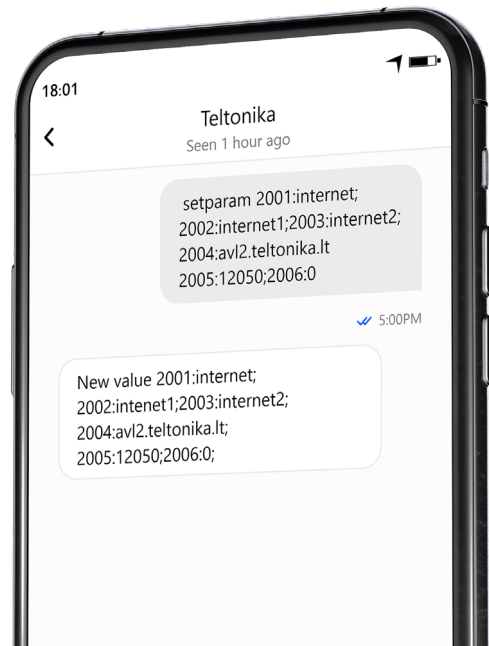

DEFAULT CONFIGURATION SETTINGS

MOVEMENT AND IGNITION DETECTION:



VEHICLE MOVEMENT
will be detected by
accelerometer



IGNITION
will be detected by
vehicle power voltage
between 13,2 – 30 V

DEVICE MAKES A RECORD ON STOP IF:



1 HOUR PASSES
while vehicle is
stationary and
ignition is off



EVERY 120 SECOND
it is sent to the server
If device has made a
record

DEVICE MAKES A RECORD ON MOVING IF ONE OF THESE EVENTS HAPPEN:



PASSES
300 seconds



VEHICLE DRIVES
100 meters



VEHICLE TURNS
10 degrees



SPEED DIFFERENCE
between last coordinate
and current position is
greater than 10 km/h

After successful SMS configuration, FMC650 device will synchronize time and update records to configured server. Time intervals and default I/O elements can be changed by using [Teltonika Configurator](#)¹ or [SMS parameters](#)².

¹ wiki.teltonika-gps.com/view/Teltonika_Configurator

² wiki.teltonika-gps.com/view/Template:FMC_Device_Family_Parameter_list

MOUNTING RECOMMENDATIONS

CONNECTING WIRES

- Wires should be fastened to the other wires or non-moving parts. Try to avoid heat emitting and moving objects near the wires.
- The connections should not be seen very clearly. If factory isolation was removed while connecting wires, it should be applied again.
- If the wires are placed in the exterior or in places where they can be damaged or exposed to heat, humidity, dirt, etc., additional isolation should be applied.
- Wires cannot be connected to the board computers or control units.

CONNECTING POWER SOURCE

- Be sure that after the car computer falls asleep, power is still available on chosen wire. Depending on car, this may happen in 5 to 30 minutes period.
- When module is connected, measure voltage again to make sure it did not decrease.
- It is recommended to connect to the main power cable in the fuse box.
- Use 3A, 125V external fuse.

CONNECTING IGNITION WIRE

- Be sure to check if it is a real ignition wire i. e. power does not disappear after starting the engine.
- Check if this is not an ACC wire (when key is in the first position, most of the vehicle electronics are available).
- Check if power is still available when you turn off any of vehicles devices.
- Ignition is connected to the ignition relay output. As alternative, any other relay, which has power output when ignition is on, may be chosen.

CONNECTING GROUND WIRE

- Ground wire is connected to the vehicle frame or metal parts that are fixed to the frame.
- If the wire is fixed with the bolt, the loop must be connected to the end of the wire.
- For better contact scrub paint from the spot where loop is going to be connected.

LED INDICATIONS

NAVIGATION LED INDICATIONS

BEHAVIOUR	MEANING
Permanently switched on	GNSS signal is not received
Blinking every second	Normal mode, GNSS is working
Off	GNSS is turned off because: Device is not working or Device is in sleep mode
Blinking fast constantly	Device firmware is being flashed

STATUS LED INDICATIONS

BEHAVIOUR	MEANING
Blinking every second	Normal mode
Blinking every two seconds	Sleep mode
Blinking fast for a short time	Modem activity
Off	Device is not working or Device is in boot mode

BASIC CHARACTERISTICS

MODULE

Name	FMCG650-MBX50: MeiG SLM320-PE2C, FMCG650-MCX50: MeiG SLM320-L16A
Technology	LTE(CaT1)/ 2G(GSM/GPRS)

GNSS

Module Name	Airoha AG3335MB
GNSS	GPS, GLONASS, GALILEO, BEIDOU, QZSS
Receiver	L1 and L5 dual-band GNSS receiver
Tracking sensitivity	-165 dBm
Position Accuracy	< 2.5 CEP
Hot start	< 1.5 s
Warm start	< 25 s
Cold start	< 32 s

CELLULAR

Technology	LTE Cat 1, GSM
2G bands	FMCG650-MBX50: B2/B3/B5/B8 FMCG650-MCX50: B2/B3/B5/B8

4G bands	FMC650-MBX50: LTE-FDD:B1/B3/B7/B8/B20/B28 LTE-TDD:B38/B40/B41 FMC650-MCX50: LTE-FDD:B1/B2/B3/B4/B5/B7/B8/ B20/B28 LTE-TDD:B40
----------	---

Data transfer	LTE FDD: Max 10Mbps (DL)/Max 5Mbps (UL) LTE TDD Max 8Mbps (DL)/Max 2Mbps (UL) GPRS: Max 85.6Kbps (DL)/Max 85.6Kbps (UL)
---------------	---

Data support	SMS (text/data)
--------------	-----------------

Transmit power	Class 4 for GSM850/900: 31±2dBm Class 1 for GSM1800/1900: 30±2dBm Class 3 for LTE-TDD: 23±3dBm Class 3 for LTE-FDD: 23±3dBm Bluetooth LE: up to 6.64 dBm
----------------	--

POWER

Input voltage range	8 - 32 V DC with overvoltage (compatible with pulse 5a and pulse 5b) and reverse polarity protection
---------------------	--

Back-up battery	550 mAh 8,4V Ni-MH battery
-----------------	----------------------------

Internal fuse	3 A, 125 V
---------------	------------

2 W max. Current consumption at 12 V	GPRS: average 60 mA Nominal: average 45 mA (with no load) GNSS sleep: average 32 mA Deep Sleep: average 4 mA Online Deep Sleep: average 11 mA Full Load/Peak: <0.25A Max
--	---

2 W max. Current consumption at 24 V	GPRS: average 35 mA Nominal: average 24 mA (with no load) GNSS sleep: average 17 mA Deep Sleep: average 2,9 mA Online Deep Sleep: average 7 mA Full Load/Peak: <0.25A Max
--	--

INTERFACE

Digital Inputs	4
----------------	---

Digital Outputs	4
-----------------	---

Analog Inputs	4
---------------	---

1-Wire temperature sensors	6
----------------------------	---

1-Wire iButton	1
----------------	---

RS232	2
-------	---

RS485	1
-------	---

CAN J1939	2
-----------	---

J1708	1
-------	---

K-Line	1
--------	---

LVCAN/ALLCAN	1
--------------	---

GNSS antenna	External High Gain
--------------	--------------------

GSM antenna	External High Gain
-------------	--------------------

USB	2.0 Mini-USB
-----	--------------

LED indication	2 status LED lights
----------------	---------------------

SIM	Mini-SIM
SIM	2x SIM Card (Dual-SIM) or 1x eSIM
Memory	16MB internal flash memory and external SD card up to 32 GB.
Switchable CAN terminators	Supported on CAN1 and CAN2 lines

FEATURES

Sensors	Accelerometer
Scenarios	Green Driving, Over Speeding detection, Jamming detection, GNSS Fuel Counter, Excessive Idling detection, Immobilizer, iButton Read Notification, Unplug detection, Towing detection, Crash detection, Auto Geofence, Manual Geofence, Trip ¹
Sleep modes	GPS Sleep, Online Deep Sleep, Deep Sleep²
Configuration and firmware update	FOTA Web³, FOTA⁴, Teltonika Configurator⁵ (USB, Bluetooth), FMBT mobile application⁶ (Configuration)

¹wiki.teltonika-gps.com/view/FMC650_Features_settings

²wiki.teltonika-gps.com/view/FMC650_Sleep_modes

³wiki.teltonika.lt/view/FOTA_WEB

⁴wiki.teltonika.lt/view/FOTA

⁵wiki.teltonika.lt/view/Teltonika_Configurator

⁶teltonika.lt/product/fmbt-mobile-application/

SMS	Configuration, Events, DOUT control, Debug
GPRS commands	Configuration, DOUT control, Debug
Time Synchronization	GPS, NITZ, NTP
Ignition detection	Digital Input 1, Accelerometer, External Power Voltage, Engine

PHYSICAL SPECIFICATION

Dimensions	104,1 x 76,8 x 31,5 mm (L x W x H)
Weight	197 g

OPERATING ENVIRONMENT

Operating temperature (without battery)	-40 °C to +85 °C
Storage temperature (without battery)	-40 °C to +85 °C
Battery Charging temperature	Ta = 20 ± 5 °C (Ambient Temp.)
Battery Discharge temperature	Ta = 20 ± 5 °C (Ambient Temp.)
Battery storage temperature	-20 °C to +45° C
Operating humidity	5% to 95% non-condensing
Ingress Protection Rating	IP41

ELECTRICAL CHARACTERISTICS

CHARACTERISTIC DESCRIPTION	VALUE			
	SUPPLY VOLTAGE	MIN.	TYP.	MAX. UNIT
Supply Voltage (Recommended Operating Conditions)	+8		+32	V

DIGITAL OUTPUT (OPEN DRAIN GRADE)

Drain current (Digital Output OFF)			120	μA
Drain current (Digital Output ON, Recommended Operating Conditions)			0.5	A
Static Drain-Source resistance (Digital Output ON)		400	300	mΩ

DIGITAL INPUT

Input resistance (DIN1)	15			kΩ
Input resistance (DIN2)	15			kΩ
Input resistance (DIN3)	15			kΩ

CHARACTERISTIC DESCRIPTION	VALUE			
	SUPPLY VOLTAGE	MIN.	TYP.	MAX. UNIT
Input resistance (DIN4)	15			kΩ
Input voltage (Recommended Operating Conditions)	0		Supply voltage	V
Input Voltage threshold (DIN1, DIN2, DIN3, DIN4)			7.5	V

ANALOG INPUT

Input Voltage (Recommended Operating Conditions), Range 1	0		+10	V
Input resistance			120	kΩ
Input Voltage (Recommended Operating Conditions), Range 2	0		+30	V
Input resistance			147	kΩ

1-WIRE

Supply voltage	+3.3		+3.9	V
Output inner resistance			7	Ω
Output current (UOUT> 3.0 V)			30	mA

CHARACTERISTIC DESCRIPTION**VALUE****SUPPLY VOLTAGE****MIN.****TYP.****MAX.****UNIT**Short circuit current
(UOUT > 0 V)

75

mA

CAN INTERFACEInternal terminal
resistors CAN bus

120

 Ω Differential input
resistance

19

30

52

k Ω Recessive output
voltage

2

2.5

3

V

Differential output
voltage

0.5

0.7

0.9

V

Common mode input
voltage

-30

30

V

SAFETY INFORMATION

This message contains information on how to operate FMC650 safely. By following these requirements and recommendations, you will avoid dangerous situations. You must read these instructions carefully and follow them strictly before operating the device!

- The device uses SELV limited power source. The nominal voltage is +12 V DC. The allowed voltage range is +8...+32 V DC.
- To avoid mechanical damage, it is advised to transport the device in an impact-proof package. Before usage, the device should be placed so that its LED indicators are visible. They show the status of device operation.
- When connecting the 2x6 connector wires to the vehicle, the appropriate jumpers of the vehicle power supply should be disconnected.
- Before unmounting the device from the vehicle, the 2x6 connector must be disconnected. The device is designed to be mounted in a zone of limited access, which is inaccessible to the operator. All related devices must meet the requirements of EN 62368-1 standard. The device FMC650 is not designed as a navigational device for boats.



Do not disassemble the device. If the device is damaged, the power supply cables are not isolated or the isolation is damaged, DO NOT touch the device before unplugging the power supply.



All wireless data transferring devices produce interference that may affect other devices which are placed nearby.



The device must be connected only by qualified personnel.



The device must be firmly fastened in a predefined location.



The programming must be performed using a PC with autonomic power supply.



Installation and/or handling during a lightning storm is prohibited.



The device is susceptible to water and humidity.



CAUTION: Risk of explosion if battery is replaced by an incorrect type. Dispose of used batteries according to the instructions.



Battery should not be disposed of with general household waste. Bring damaged or worn-out batteries to your local recycling center or dispose them to battery recycle bin found in stores.

CERTIFICATION AND APPROVALS



This sign on the package means that it is necessary to read the User's Manual before you start using the device. Full User's Manual version can be found in our [Wiki](#)¹.

¹ wiki.teltonika-gps.com/index.php?title=FMC650



This sign on the package means that all used electronic and electric equipment should not be mixed with general household waste.

CHECK ALL CERTIFICATES

All newest certificates may be found in our [Wiki](#)².

² wiki.teltonika-gps.com/view/FMC650_Certification_%26_Approvals

WARRANTY

We guarantee our products 24-month warranty¹ period.

All batteries carry a 6-month warranty period.

Post-warranty repair service for products is not provided.

If a product stops operating within this specific warranty time, the product can be:

- Repaired
- Replaced with a new product
- Replaced with an equivalent repaired product fulfilling the same functionality
- Replaced with a different product fulfilling the same functionality in case of EOL for the original product

¹ Additional agreement for an extended warranty period can be agreed upon separately.

WARRANTY DISCLAIMER

- Customers are only allowed to return products as a result of the product being defective, due to order assembly or manufacturing fault.
- Products are intended to be used by personnel with training and experience.
- Warranty does not cover defects or malfunctions caused by accidents, misuse, abuse, catastrophes, improper maintenance or inadequate installation – not following operating instructions (including failure to heed warnings) or use with equipment with which it is not intended to be used.
- Warranty does not apply to any consequential damages.
- Warranty is not applicable for supplementary product equipment (i. e. PSU, power cables, antennas) unless the accessory is defective on arrival.
- [More information on what is RMA¹](#)

¹ wiki.teltonika-gps.com/view/RMA_guidelines