



# 100 Mbps PoE Switch

Quick Start Guide



## Preface

### Applicable Models

This manual is applicable to 100 Mbps PoE switches.

### Symbol Conventions

The symbols that may be found in this document are defined as follows.

Symbol	Description
 <b>Danger</b>	Indicates a hazardous situation which, if not avoided, will or could result in death or serious injury.
 <b>Caution</b>	Indicates a potentially hazardous situation which, if not avoided, could result in equipment damage, data loss, performance degradation, or unexpected results.
 <b>Note</b>	Provides additional information to emphasize or supplement important points of the main text.

# Chapter 1 Introduction

## 1.1 Product Introduction

DS-3E1300P series switches (hereinafter referred to as "the device") are layer 2 PoE switches, providing advanced PoE power supply technology on the basis of Internet access. The switches support client management, network topology management, link aggregation, port management and so on. The switches are suitable for small-scale LAN device access.

## 1.2 Packing List

Item	Quantity
Switch	× 1
Power Adapter	× 1
AC Power Cord	× 1
Quick Start Guide	× 2

## 1.3 Appearance

Different models of devices may have different appearances. The following pictures are only for illustration.

### 1.3.1 Front Panel

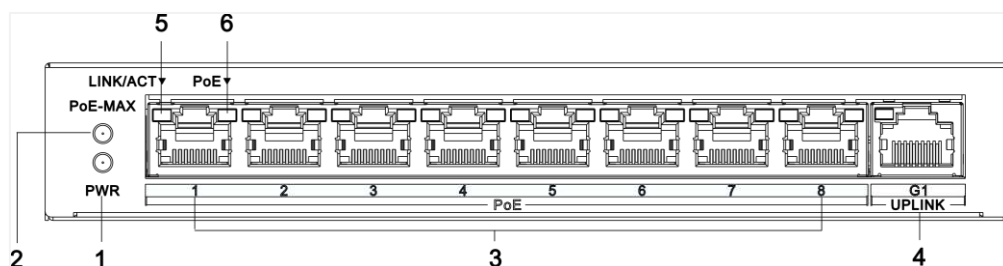
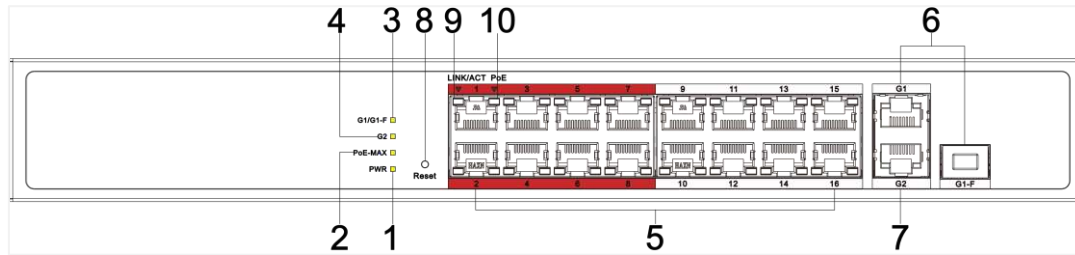

Figure 1-1 1309P Series

No.	Indicator/Port	Description
1	PWR Indicator	<ul style="list-style-type: none"> <li>● Solid: The switch is powered on normally.</li> <li>● Unlit: No power supply connected or power supply is abnormal.</li> </ul>
2	PoE-MAX Indicator	<ul style="list-style-type: none"> <li>● Solid /Flashing: The output power of the switch will reach the upper limit. The power supply may be abnormal if more devices are connected.</li> <li>● Unlit: The switch provides power supply to PD normally.</li> </ul>
3	100 Mbps PoE RJ45 Port	Used for PD devices connection via network cables.
4	1000 Mbps RJ45 Port (G1)	Used for other devices connection via network cables.
5	LINK/ACT Indicator	<ul style="list-style-type: none"> <li>● Solid: The port is connected.</li> <li>● Flashing: The port is transmitting data.</li> <li>● Unlit: The port is disconnected or connection is abnormal.</li> </ul>
6	PoE Indicator	<ul style="list-style-type: none"> <li>● Solid: The switch provides power supply to PD normally.</li> <li>● Unlit: The switch is disconnected to PD, or provides power supply to PD abnormally.</li> </ul>

## 100 Mbps PoE Switch Quick Start Guide



**Figure 1-2 1318P Series**

### **Note**

The front panel of 1326P switch is similar to that of 1318P, with differences on 24 100Mbps PoE RJ45 ports, 24 LINK/ACT, and 24 PoE indicators.

No.	Indicator/Port	Description
1	PWR Indicator	<ul style="list-style-type: none"> <li>● Solid: The switch is powered on normally.</li> <li>● Unlit: No power supply connected or power supply is abnormal.</li> </ul>
2	PoE-MAX Indicator	<ul style="list-style-type: none"> <li>● Solid/Flashing: The output power of the switch will reach the upper limit. The power supply may be abnormal if more devices are connected.</li> <li>● Unlit: The switch provides power supply to PD normally.</li> </ul>
3	G1/G1-F Indicator	<ul style="list-style-type: none"> <li>● Solid: The port is connected.</li> <li>● Flashing: The port is transmitting data.</li> <li>● Unlit: The port is disconnected or connection is abnormal.</li> </ul>
4	G2 Indicator	<ul style="list-style-type: none"> <li>● Solid: The port is connected.</li> <li>● Flashing: The port is transmitting data.</li> <li>● Unlit: The port is disconnected or connection is abnormal.</li> </ul>
5	100 Mbps PoE RJ45 Port	Used for PD devices connection via network cables.
6	1000 Mbps Gigabit Combo (G1/G1-F)	<ul style="list-style-type: none"> <li>● When connected to a network cable, the combo is a RJ45 port. When plugged into with an optical module and connected to an optical fiber, the combo functions as a fiber optic port.</li> <li>● When connected to both the network cable and optical fiber at the same time, the port works as a fiber optic port.</li> </ul>
7	1000 Mbps RJ45 Port (G2)	Used for other devices connection via network cables.
8	Reset	Restore device to the defaults.
9	LINK/ACT Indicator	<ul style="list-style-type: none"> <li>● Solid: The port is connected.</li> <li>● Flashing: The port is transmitting data.</li> <li>● Unlit: The port is disconnected or connection is abnormal.</li> </ul>
10	PoE Indicator	<ul style="list-style-type: none"> <li>● Solid: The switch provides power supply to PD normally.</li> <li>● Unlit: The switch is disconnected to PD, or provides power supply to PD abnormally.</li> </ul>

### 1.3.2 Rear Panel



Figure 1-3 1309P Series



Figure 1-4 1318P/1326P Series

No.	Indicator/Port	Description
1	Grounding Terminal	Used for connecting to the grounding cable to protect the switch from lightning.
2	Power Supply	Use the attached power cord to connect the switch to socket.
3	Reset	Restore to the defaults.

## Chapter 2 Installation

Please select the appropriate installation method according to the actual needs.

### Before You Start

- Ensure that the desktop or rack is stable and firm enough.
- Keep the room well-ventilated. Keep at least 10 cm distance around the device for heat dissipation.
- Keep at least 1.5 cm vertical distance between two adjacent devices for rack-mount installation.

### 2.1 Desk-Mounted Installation

Place the device on the desk.

### 2.2 Wall-Mounted Installation

#### Steps

1. Check the distance between the two hanging holes on the rear cover of the device.
2. Insert two M4 screws into the wall.

---

#### Note

- Please prepare two M4 screws.
  - Ensure that the distance between the two screws equals that between the two hanging holes.
  - Set aside at least 4 mm screws outside the wall.
- 

3. Align the hanging holes with screws, and hang the device on the screws.

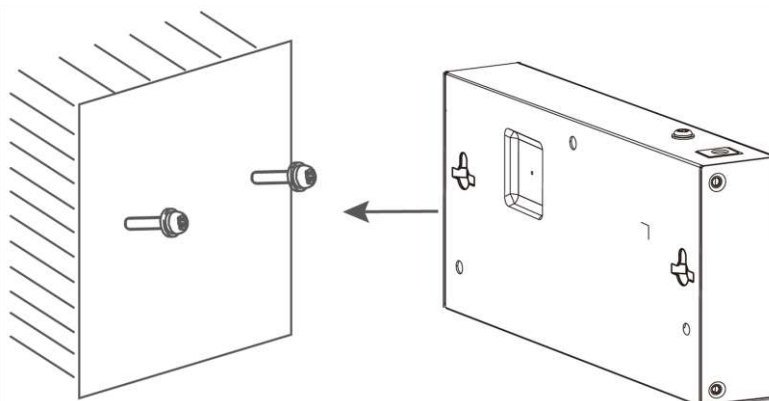
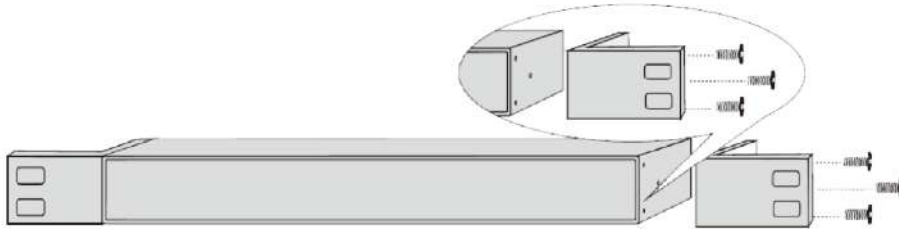

Figure 2-1 Wall-Mounted Installation

## 2.3 Rack-Mounted Installation

### Steps

1. Check the grounding and stability of the rack.
2. Use the attached screws to fix the two L-shaped brackets to the sides of the switch.



**Figure 2-2 Fix L-Shaped Brackets**

3. Place your switch on the rack, fix it to the rack with self-prepared screws to stably install your switch.

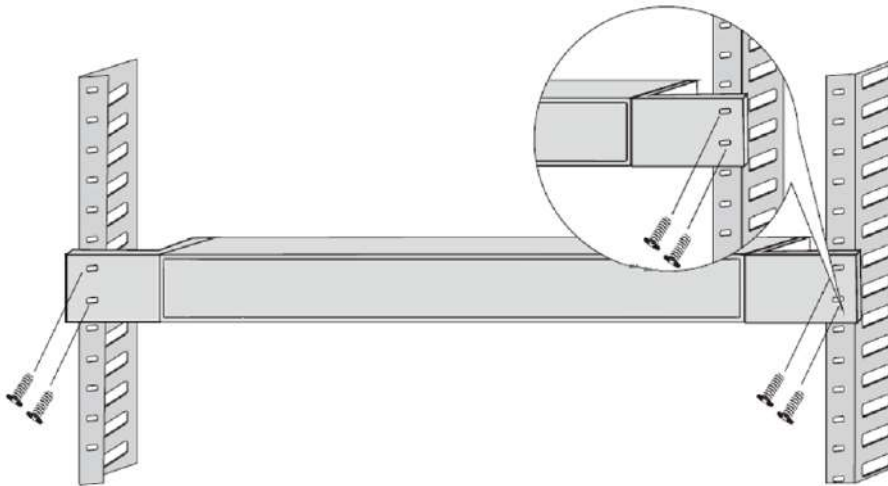

**Figure 2-3 Fix to the Rack**



## Chapter 3 Grounding

### 3.1 Connecting the Grounding Cable

Grounding is used to quickly release overvoltage and overcurrent induced by lightning for switch, and to protect personal safety. Select the appropriate grounding method according to your needs.

#### 3.1.1 With Grounding Bar

If a grounding bar is available at the installation site, follow the steps below.

##### Steps

1. Connect one end of the grounding cable to the binding post on the grounding bar.
2. Connect the other end of the grounding cable to the grounding terminal of the device and fix the screw.

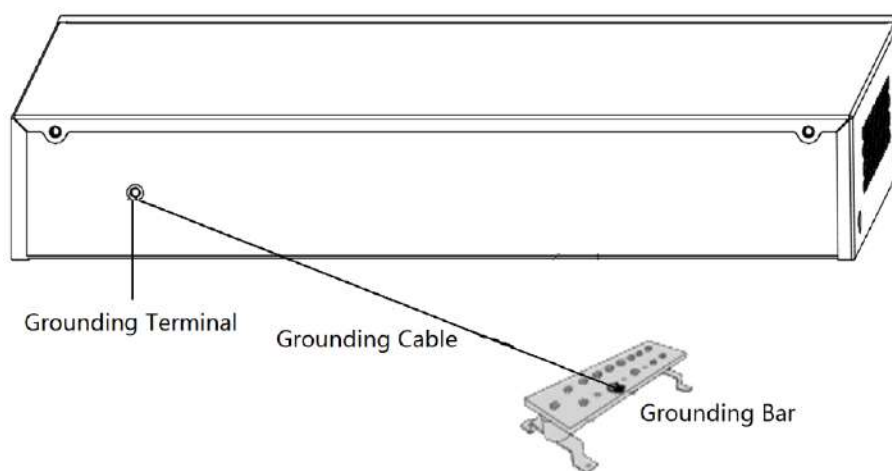

Figure 3-1 Grounding with Grounding Bar

#### 3.1.2 Without Grounding Bar

If there is no grounding bar but the earth is nearby and the grounding body is allowed to be buried, follow the steps below.

##### Steps

1. Bury an angle steel or steel pipe ( $\geq 0.5$  m) into the mud land.
2. Weld one end of the grounding cable to the angle steel or steel pipe and embalm the welding point via electroplating or coating.

3. Connect the other end of the grounding cable to the grounding terminal.

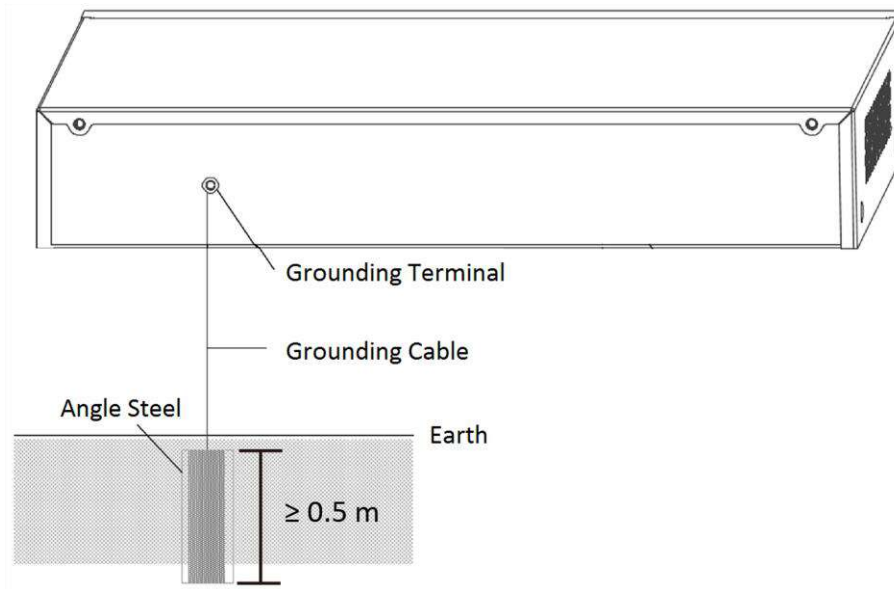

**Figure 3-2 Grounding with Angle Steel**

## 3.2 Connecting RJ45 Port

Use a network cable to connect the device to the RJ45 port of a peer device such as network camera, NVR, switch, etc.

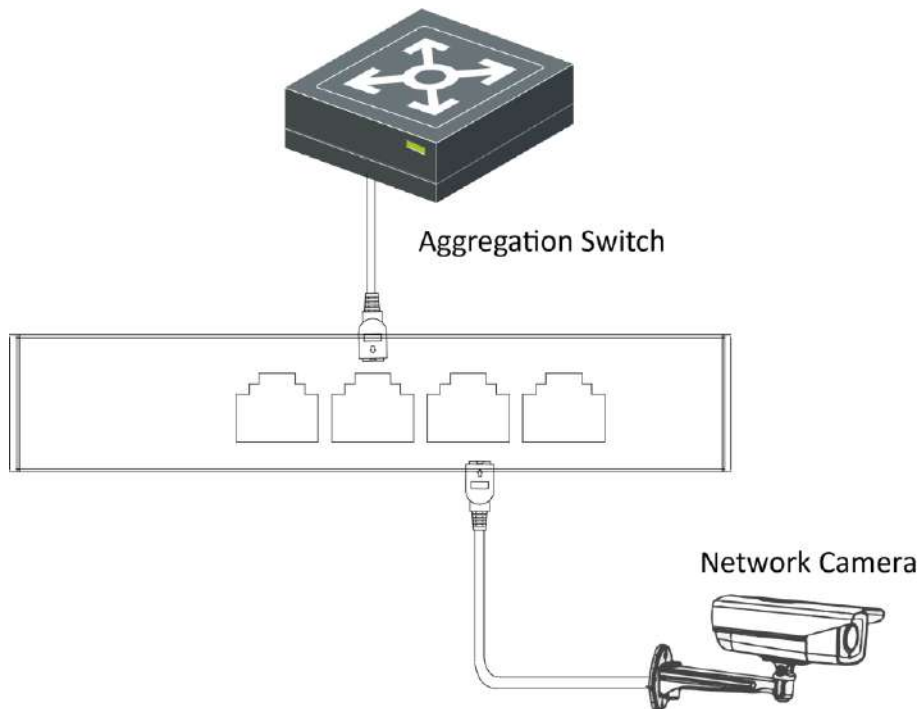

**Figure 3-3 RJ45 Port Connection**

### 3.3 Connecting SFP Optical Module

Connecting SFP optical module is supported when the device has a fiber optic port or a combo.

When connected to a network cable, the combo is a RJ45 port. When plugged into with an optical module and connected to an optical fiber, the combo functions as a fiber optic port.

When connected to both the network cable and optical fiber at the same time, the port works as a fiber optic port.

#### Steps

---

##### Caution

- Single-Mode optical module needs to be paired.
  - Do not bend fiber optic (curvature radius  $\geq 10$  cm) overly.
  - Do not look directly at fiber optic connector because the laser is harmful to eyes.
- 

1. Connect the two paired SFP optical modules with an optical fiber.
2. Hold the SFP optical module from one side, and smoothly plug it into the device along with the SFP port slot until the optical module and the device are closely attached.
3. After powering on the device, check the status of LINK/ACT indicator. If the indicator is lit, the link is connected. If the indicator is unlit, the link is disconnected. Check the line, and make sure peer devices have been started.

## Chapter 4 Powering on the Device

Please use the attached power cord in package to power on the device.

Before powering your switch, make sure that:

- The operating power supply is compliant with rated input standard.
  - Port cables and grounding cables are correctly connected.
  - If there is outdoor cabling, connect a lightning rod and lightning arrester to the cable.
- 

### **Caution**

PoE power supply line and strong wire cannot be wired together, otherwise PD equipment or switch ports will be burnt.

---

## Chapter 5 Device Management

The device can be configured and managed through iVMS-4200 software, mainly including network parameter configuration, port configuration, link aggregation configuration, network topology display and so on.

### Note

- This chapter will briefly introduce device management through iVMS-4200 software. For other functions, please refer to user manual of iVMS-4200 software.
- All pictures in this manual are for illustration only, and the specific interface is subject to the actual interface.

## 5.1 Activating Devices

For the inactive devices, you are required to create a password to activate them before they can be added to the software and work properly.

### Before You Start

Make sure the device to be activated is connected to the network and is in the same subnet with the PC running the client.

### Steps

#### Note

This function should be supported by the device.

1. Enter the Device Management page.
2. Click **Device** tab on the top of the right panel.
3. Click **Online Device** to show the online device area at the bottom of the page.  
The searched online devices are displayed in the list.
4. Check the device status (shown on **Security Level** column) and select an inactive device.

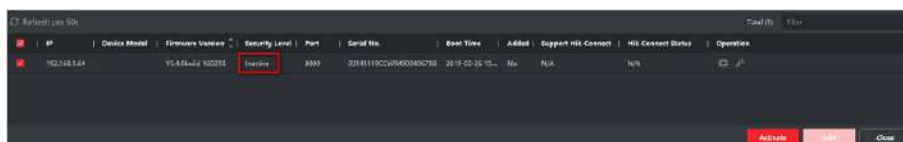

Figure 5-1 Online Inactive Device

5. Click **Activate** to open the Activation dialog.
6. Create a password in the password field, and confirm the password.

### **Caution**

The password strength of the device can be automatically checked. We highly recommend you change the password of your own choosing (using a minimum of 8 characters, including at least three kinds of following categories: upper case letters, lower case letters, numbers, and special characters) in order to increase the security of your product. And we recommend you change your password regularly, especially in the high security system, changing the password monthly or weekly can better protect your product.

Proper configuration of all passwords and other security settings is the responsibility of the installer and/or end-user.

---

7. Click **OK** to activate the device.

## 5.2 Adding Devices

The client provides various device adding modes including IP/domain, IP segment, cloud P2P, ISUP protocol, and HiDDNS. The client also supports importing multiple devices in a batch when there are large amount of devices to be added. The section only introduces one mode, namely, adding a detected online device.

### Steps

1. Enter the Device Management module.
  2. Click **Device** tab on the top of the right panel.
  3. Click **Online Device** to show the online device area.  
The searched online devices are displayed in the list.
  4. Select an online device in the **Online Device** area, and click **Add** to open the device adding window.
- 

### **Note**

For the inactive device, you need to create the password for it before you can add the device properly. For detailed steps, refer to *Activating Devices*.

---

5. Enter the required information.

#### **Name**

Enter a descriptive name for the device.

#### **IP Address**

Enter the device's IP address. The IP address of the device is obtained automatically in this adding mode.

#### **Port**

You can customize the port number. The port number of the device is obtained automatically in this adding mode.

---

### User Name

By default, the user name is *admin*.

### Password

Enter the device password.

---

### Caution

The password strength of the device can be automatically checked. We highly recommend you change the password of your own choosing (using a minimum of 8 characters, including at least three kinds of following categories: upper case letters, lower case letters, numbers, and special characters) in order to increase the security of your product. And we recommend you change your password regularly, especially in the high security system, changing the password monthly or weekly can better protect your product.

Proper configuration of all passwords and other security settings is the responsibility of the installer and/or end-user.

---

6. Check **Synchronize Time** to synchronize the device time with the PC running the client after adding the device to the client.
7. Click **Add**.

## Chapter 6 Get More Information

Scan the QR code below for iVMS-4200 software operations.







See Far, Go Further