



**CONTROL PANEL  
FOR 120 V OR 230 V GEARMOTORS**

FA00679-EN





**ZF1N110 / ZF1N**

**INSTALLATION MANUAL**

EN English

**IMPORTANT SAFETY INSTRUCTIONS WHEN INSTALLING**  
**WARNING: INCORRECT INSTALLATION MAY RESULT IN SERIOUS HARM, FOLLOW THE INSTALLATION INSTRUCTIONS.**  
**THIS MANUAL IS EXCLUSIVELY INTENDED FOR PROFESSIONAL, SKILLED STAFF**

## KEY

-  This symbol shows which parts to read carefully.
-  This symbol shows which parts describe safety issues
-  This symbol shows which parts to tell users about.

## DESCRIPTION

Control panel for two-leaved swing gates. Set functions by using DIP-switches and adjust them by using the trimmers.

All connections and links are rapid-fuse protected.

### Intended use

The ZF1N110 / ZF1N control panel is designed to control CAME gearmotors for swing gates in private homes and apartment buildings.

-  Any installation and/or use other than that specified in this manual is forbidden.

### Technical data

Type	ZF1N	ZF1N110
Protection rating (IP)		54
Power supply (V - 50/60 Hz)	230 AC	120 AC
Input voltage motor (V)	230 AC	120 AC
Consumption in stand-by mode (mA)		40
Maximum power (W)		320
Casing material		ABS
Operating temperature (°C)		-20 to +55
Apparatus class		
Weight (Kg)		-

Fuses	ZF1N	ZF1N110
LINE FUSE - Line	5 A	8 A
C.BOARD - Card		315mA
ACCESSORIES - Accessories		3.15 A

### Dimensions (mm)

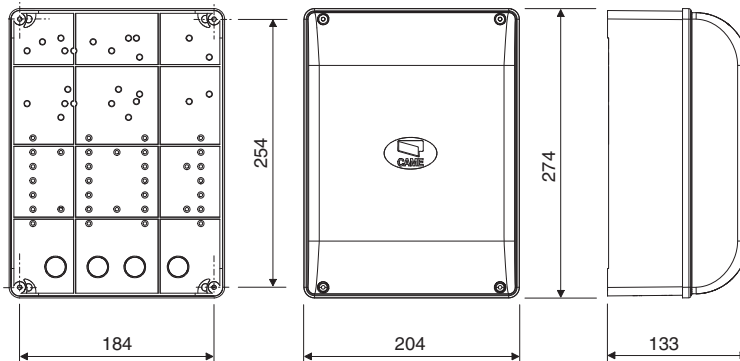

## Description of parts

- ① Transformer
- ② Line fuse
- ③ Power supply terminals
- ④ Transformer terminal boards
- ⑤ Control-board fuse
- ⑥ Terminals for control and safety devices
- ⑦ Alert LED
- ⑧ Antenna terminal
- ⑨ DIP-SWITCH
- ⑩ AF card connector
- ⑪ Automatic closing trimmer
- ⑫ Operating time trimmer
- ⑬ Motor 2 delay trimmer
- ⑭ Programming key
- ⑮ Accessories fuse
- ⑯ Terminal board for microswitches

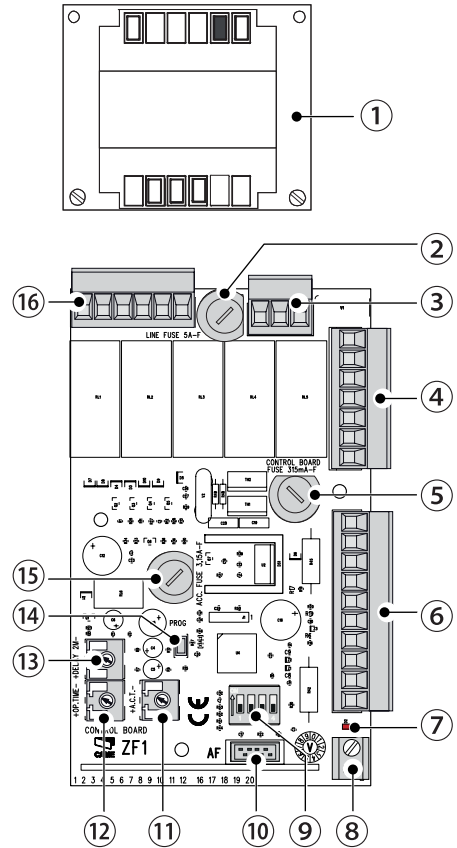

## GENERAL INSTALLATION INDICATIONS

△ Only skilled, qualified staff must install this product.

△Warning! Before working on the control panel, cut off the main power supply and, if present, remove any batteries.

### Preliminary checks

△ Before installing the control panel, do the following:

- make sure the fastening points and the anchoring surface are solid and protected from impacts. Only use suitable nuts, bolts, dowels, and so on;
- set up a suitable dual pole cut off device along the power supply that is compliant with the installation rules. It should completely cut off the power supply according to category III surcharge conditions;
- ⊕ make sure that any connections inside the container (ones that ensure continuity to the protection circuit) are fitted with additional insulation with respect to those of other electrical parts inside;
- set up suitable tubes and conduits for the electric cables to pass through, making sure they are protected from any mechanical damage.

## Tools and materials

Make sure you have all the tools and materials you will need for installing in total safety and in compliance with applicable regulations. The figure shows some of the equipment installers will need.

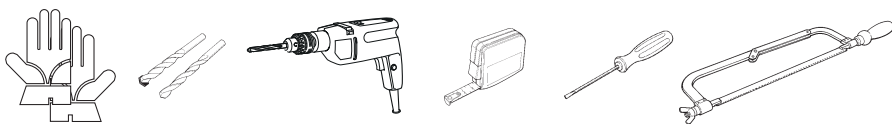

## Cable types and minimum thicknesses

Connection	cable length	
	< 20 m	20 < 30 m
Control panel 120 / 230 V AC (1P+N+PE)	3G x 1.5 mm <sup>2</sup>	3G x 2.5 mm <sup>2</sup>
Gearmotor 120 / 230 V AC	4G x 1.5 mm <sup>2</sup>	4G x 2.5 mm <sup>2</sup>
TX Photocells	2 x 0.5 mm <sup>2</sup>	
RX photocells	4 x 0.5 mm <sup>2</sup>	
Flashing light	2 x 0.5 mm <sup>2</sup>	
Command and control devices	2 x 0.5 mm <sup>2</sup>	
Safety devices	2 x 0.5 mm <sup>2</sup>	

📖 When powered at 120 V or 230 V and used outdoors, use H05RN-F-type cables that comply with 60245 IEC 57 (IEC); whereas indoors, use H05VV-F-type cables that are 60227 IEC 53 (IEC) compliant.

Use RG58 cable up to 10 m long to connect the antenna.

📖 If cable lengths differ from those specified in the table, establish the cable sections depending on the actual power draw of the connected devices and according to the provisions of regulation CEI EN 60204-1.

📖 For multiple, sequential loads along the same line, the dimensions on the table need to be recalculated according to the actual power draw and distances. For connecting products that are not contemplated in this manual, see the literature accompanying said products

## INSTALLATION

### Fastening the control panel

Fasten the control panel in a protected area using suitable screws and dowels ❶.

📖 Only use 6 x 70 mm cylinder-head screws.

Drill through the pre-drilled holes (18 and 20 mm) under the control panel's base ❷.

⚠ Be careful not to damage the control board.

Enter the cable gland with the corrugated tubes for threading the electrical cables ❸.

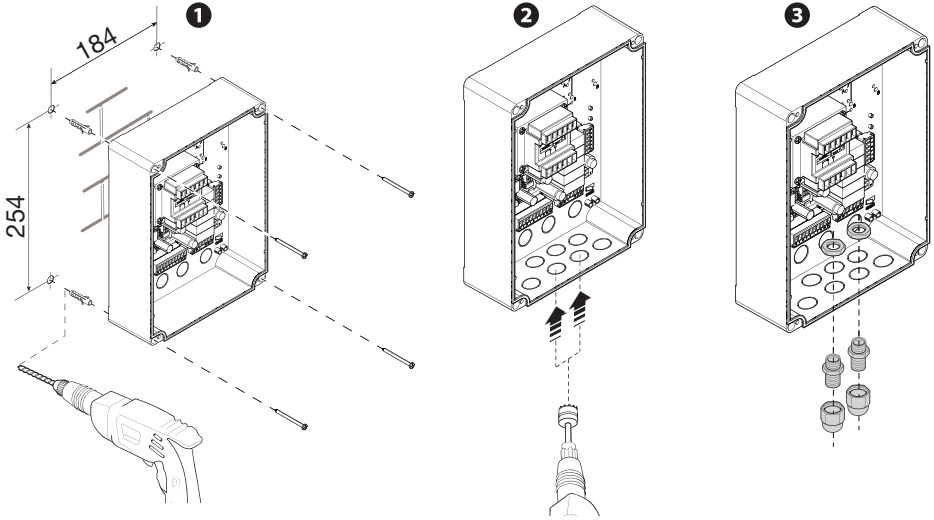

## ELECTRICAL CONNECTIONS

### Input voltage

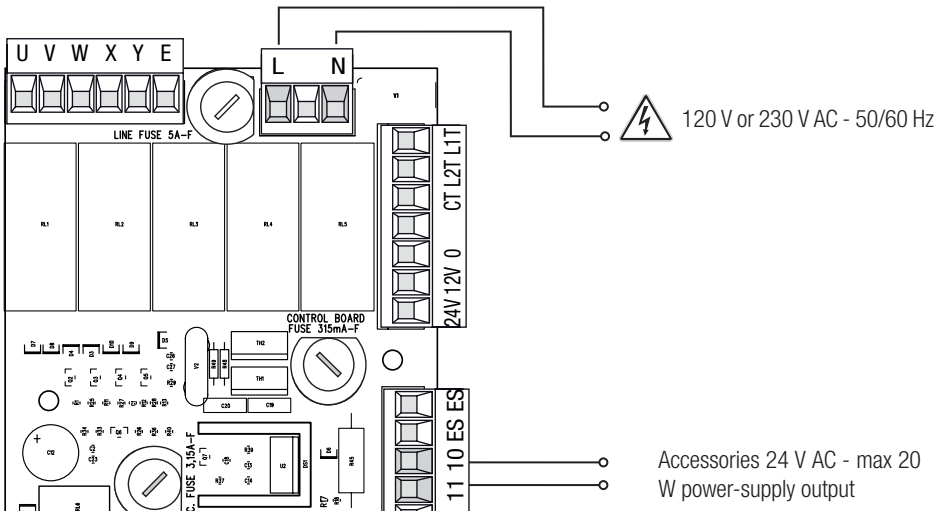

## Connecting the gearmotors

Gearmotor (M1) 120 V AC\* or 230 V AC, delayed when opening.



Gearmotor (M2) 120 V AC\* or 230 V AC, delayed when closing.

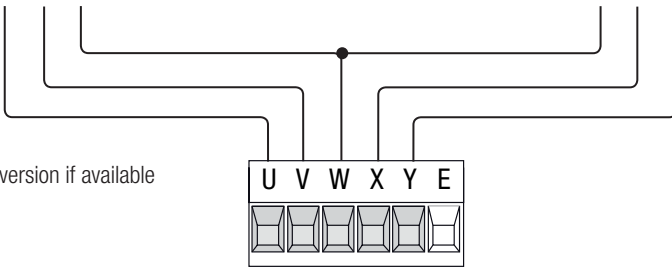

\* 120 V AC version if available

## Motor's torque limiter

To vary the motor torque, move the faston as shown to one of the four positions: 1 min ÷ 4 max.

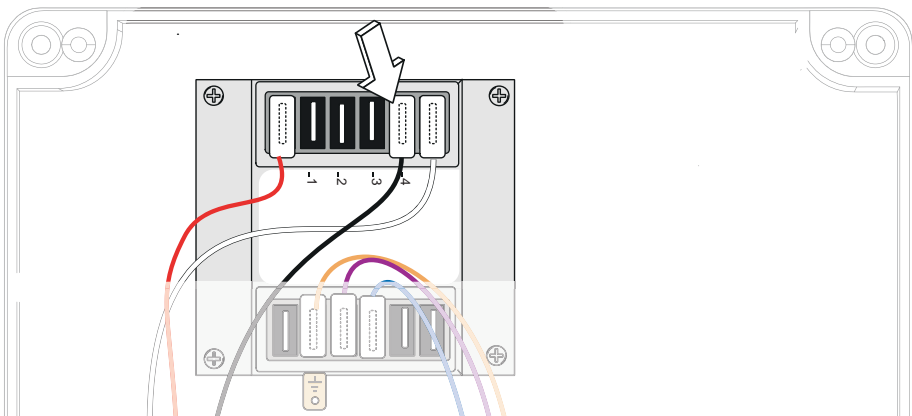

## Command and control devices

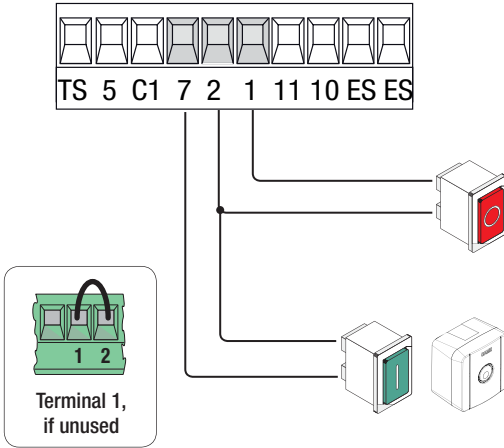

STOP button (NC contact). For stopping the gate while excluding automatic closing. To resume movement press the control button or use another control device.

If unused, short-circuit the contact.

OPEN-CLOSE-INVERT function (step-step) from control device (NO contact). Alternatively, by setting DIP-switch 2 to ON, you can activate the OPEN-STOP-CLOSE-STOP sequential command.

## Electric lock

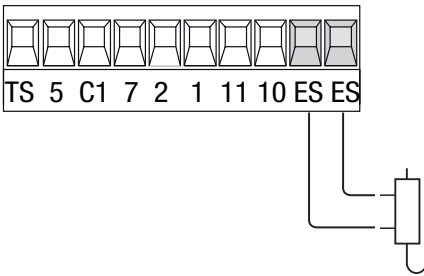

Electrolock connection at 12 V - Maximum power: 15 W

## Signaling devices

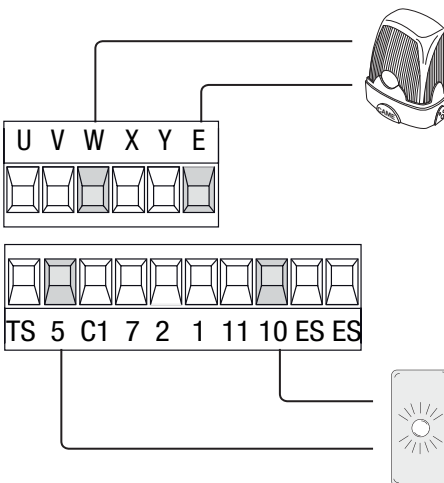

Output for connecting the flashing signal light. (Contact rated for: 120 V or 230 V AC - 25 W max.).

Gate-open signal output (contact rated for: 24 V AC - 3 W max).

To signal that the gate is open. It switches off when the gate is closed.

## Safety devices

### Photocells

Input for safety devices such as photocells.

Reopening during closing. When the gate is closing, opening the contact triggers the inversion of movement until the gate is fully open again;

 If the photocells are left unused, short-circuit contact 2-C1.

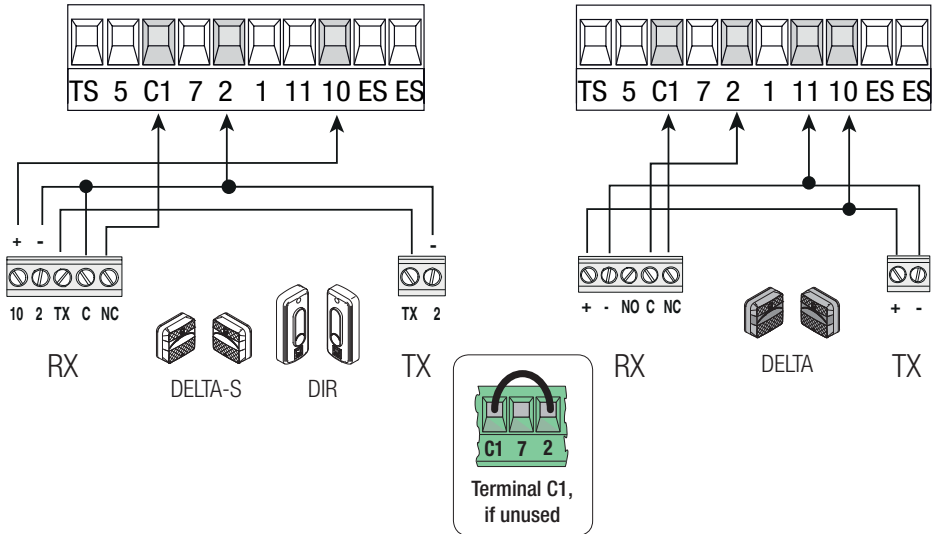

### Connecting the safety devices (i.e. the safety test)

At each opening and closing command, the control board checks the efficacy of the safety devices (such as, photocells).

Any anomalies will inhibit all commands.

For this type of connection, enable the function by setting DIP-switch 3 to ON.

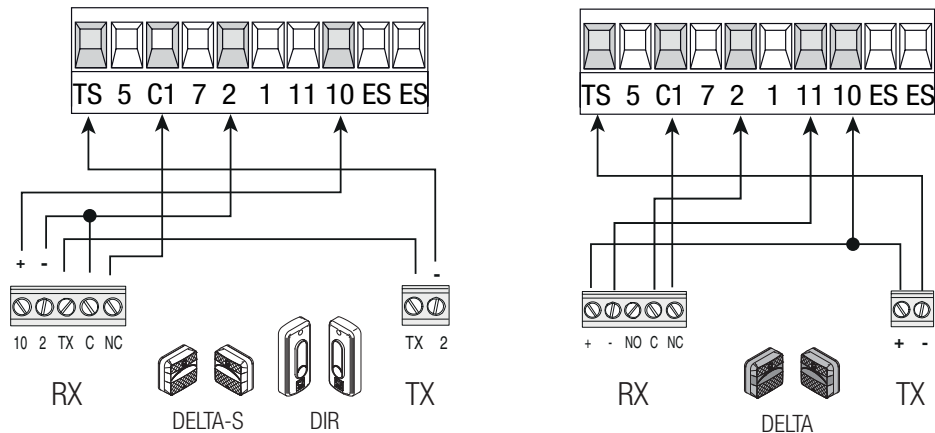



## FUNCTIONS AND SETTINGS

### Functions

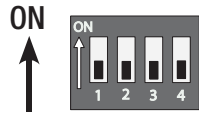
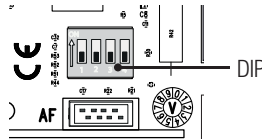

### DIP-SWITCH Description of functions



#### AUTOMATIC CLOSING

Automatic closing active (1 OFF - Deactivated)



#### OPEN-STOP-CLOSE-STOP

OPEN-STOP-CLOSE-STOP (sequential) function from control device (NO contact) and from radio transmitter fitted with AF card.



#### OPEN-CLOSE-INVERT

OPEN-CLOSE-INVERT (step-step) function from control device (NO contact) and from radio transmitter fitted with AF card.



#### SAFETY TEST

At each opening or closing command, the card checks whether the photocells are working properly (3 OFF - Deactivated)



#### DELETING USERS

Deleting one or more users (4 OFF - Deactivated)

### Settings

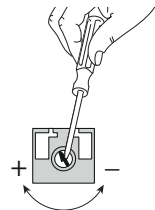
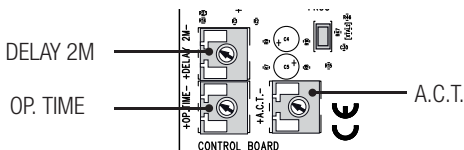

### Trimmer Description of functions

#### AUTOMATIC CLOSING TIME

It sets the open gate's waiting time. Once this time elapses, a closing maneuver is automatically performed.

#### A.C.T.

The waiting time can be adjusted to between 1 and 120 seconds.

⚠ The automatic closing does not activate if the safety devices are triggered due to obstacle detection, after a total Stop or if the current is missing.

#### OPERATING TIME

This sets the gearmotors' operating time.

#### OP. TIME

The operating time can be adjusted to between 15 and 120 seconds.

📖 Setting the time to the minimum enables the maintained action function and disables the radio-based controls.

#### MOTOR M2 CLOSING DELAY TIME

#### DELAY 2M

After a closing command or after an automatic closing, the leaf of gearmotor (M2) starts with a delay compared to gearmotor (M1) for an adjustable time of between 3 and 10 seconds.

## Preliminary operations

Connect the RG58 cable antenna cable to the corresponding terminals **1**.

Fit the AF card into the control board connector **3**.

 Before fitting the AF card, you **MUST CUT OFF THE MAIN POWER SUPPLY** and, remove any emergency batteries.

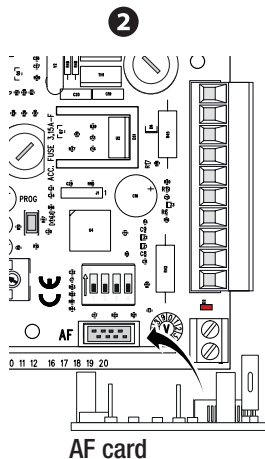
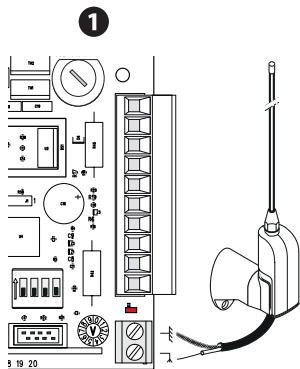

## Adding a user

 You can register up to 50 users.

Keep pressed the PROG programming button on the control board. The programming LED flashing **1**.

Press any key on the transmitter you want to memorize. The LED stays on to indicate that memorization has been successful **2**.

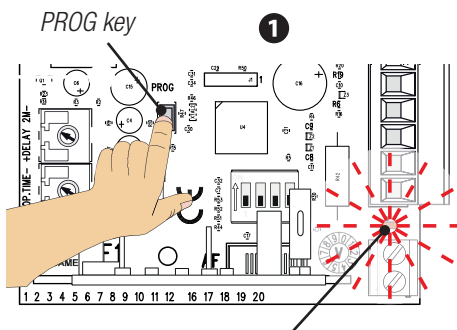

Programming LED

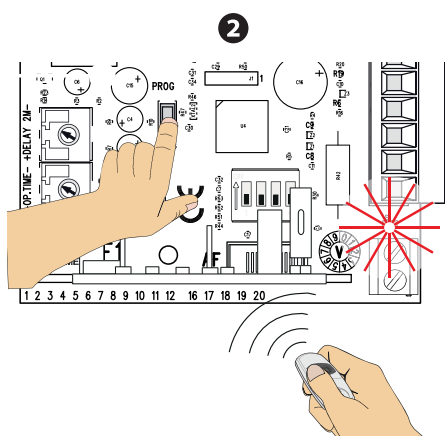

## Deleting a single user

Set DIP-switch 4 to ON.

Keep pressed the PROG button on the control board. The programming LED flashes ❶.

Within five seconds, press the button on the transmitter of the user you wish to delete. The LED will flash quickly for one second to signal that the user has been deleted, and then it will switch off ❷.

Reset DIP-switch 4 to OFF.

PROG key

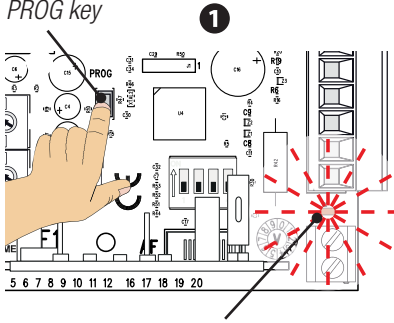

5"  
max

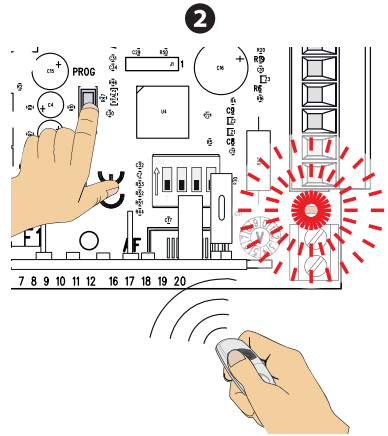

Programming LED

## Deleting all users

Set DIP-switch 4 to ON.

Keep pressed for about 10 seconds the PROG button on the control board. The programming LED will perform a series of average length flashes (about 5 seconds) and quick flashes (about 2 seconds) until it switches off.

Reset DIP-switch 4 to OFF.

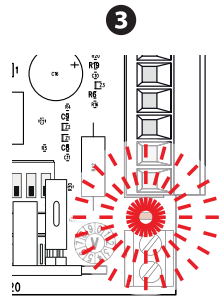
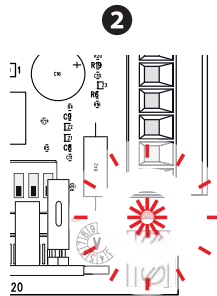
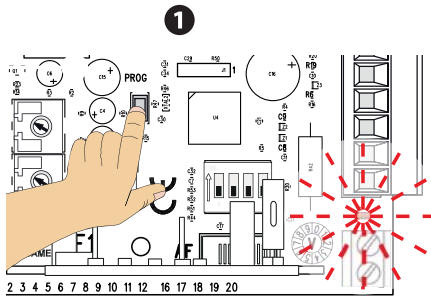

## FINAL OPERATIONS

### Fastening the cover

Once finished with the electrical connections and powering up, fit the cover and secure it using the supplied screws.

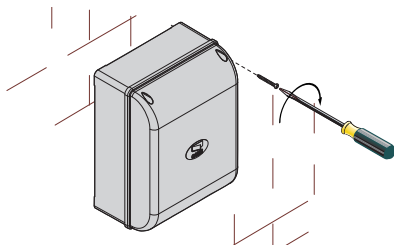

## DISMANTLING AND DISPOSAL

Always make sure you comply with local laws before dismantling and disposing of the product. The packaging materials (cardboard, plastic, and so on) should be disposed of as solid household waste, and simply separated from other waste for recycling.

Whereas other components (control boards, batteries, transmitters, and so on) may contain hazardous pollutants. These must therefore be disposed of by authorized, certified professional services.

DISPOSE OF RESPONSIBLY!

## REFERENCE REGULATIONS

CAME SpA declares that this product complies with the current directives at the time it is manufactured.

**CAME** 

[CAME.COM](http://CAME.COM)

**CAME S.P.A.**

Via Martiri Della Libertà, 15

31030 Dosson di Casier - Treviso - Italy

tel. (+39) 0422 4940 - fax. (+39) 0422 4941