



Garun Series

3 Phase IN / 3 Phase OUT UPS

User Manual

UP33TOP110KGAAZ01B
UP33TOP115KGAAZ01B
UP33TOP120KGAAZ01B
UP33TOP130KGAAZ01B

UP33TOP140KGAAZ01B
UP33TOP160KGAAZ01B
UP33TOP180KGAAZ01B



Table of contents

1. Safety and EMC instructions	5
1-1. Transportation and storage	5
1-2. Preparation	5
1-3. Installation	5
1-4. Connection warnings	6
1-5. Operation	7
1-6. Standards	7
2. Installation and operation	8
2-1. Unpacking and inspection	8
2-2. Wiring terminal view	8
2-3. Single UPS installation	12
2-4. UPS installation for parallel system	15
2-5. Software installation	16
3. Operations	17
3-1. Initial operation	17
3-2. Screen description	17
3-2.1. Main screen	18
3-2.2. Control screen	18
3-2.3. Measure screen	20
3-2.4. Setting screen	22
3-2.5. Information screen	42
3-2.6. Data Log screen	46
3-3. Audible alarm.....	47
3-4. Single UPS operation	47
3-5. Parallel operation	50
3-6. Fault code	53
3-7. Warning code	55
4. Troubleshooting	56
5. Storage and maintenance	58
5-1. Storage	58
5-2. Maintenance	58

Thank you for purchasing our products!

Please read this manual before using the product.



Focusing on quality at competitive prices, nJoy designs consumer products for a better and enjoyable way into the digital world.

This UPS will protect your electronic equipment from physical damage and will provide emergency battery backup power to prevent data loss in the event of power problems.

The following models belong to the **Garun Series**:

10K VA

Garun 10KL

15K VA

Garun 15KL

20K VA

Garun 20KL

30K VA

Garun 30KL

40K VA

Garun 40KL

60K VA

Garun 60KL

80K VA

Garun 80KL

All safety instructions in this document must be read, understood and followed.

1.1. Transportation and storage

- Please transport the UPS system only in the original packaging to protect against shock and damage.
- The UPS must be stored in the room where the temperature is well regulated. Ambient temperature should not exceed 40°C.

1.2. Preparation

- Condensation may form if the UPS system is moved from cold to warm environment immediately.
- The UPS system must be absolutely dry before being installed. Please allow at least two hours for the UPS system to acclimate to the environment.
- Do not install the UPS system near water or in moist environments.
- Do not install the UPS system where it would be exposed to direct sunlight or near a heat source.
- Do not block ventilation holes on the UPS housing.

1.3. Installation

- Do not connect appliances or devices which would overload the UPS (e.g. big motor type equipment) to the UPS output terminal.
- Place cables in such a way that no one can step on or trip over them.
- Do not block air vents on the housing of the UPS. Ensure proper unit spacing of ventilation.
- UPS equipped with a grounding terminal, in the final installation phase, connect grounding/earthing wire to the external UPS battery cabinets or appropriate grounding terminals.
- The UPS can be installed only by qualified maintenance personnel.
- An appropriate disconnect device such as short circuit backup protection should be incorporated during installation.
- An integral emergency shutoff switch which prevents additional load from the UPS in any mode of operation should be implemented during the installation.
- Secure the grounding/earthing wire before connecting to any live wire terminal.
- Installation and Wiring must be in accordance with the local electrical laws and regulations.

WARNING

Please comply with all warnings and operating instructions in this manual. This equipment should only be installed, serviced, and maintained by qualified personnel. Do not operate this unit before reading through all safety information and operating instructions carefully.

We assume no responsibility or liability for loss or damages, whether direct, indirect, consequential or incidental, which might arise out of the use of such information. The use of any such information will be entirely at the user's risk. Information in this manual is subject to change without notice. We make no commitment to update or keep current the information in this manual. If you find information in this manual that is incorrect, misleading, or incomplete, we would appreciate your comments and suggestions.



1.4. Connection warnings

- There is no standard backfeed protection inside of the UPS. However, there are relays on the Input to cut off line voltage and while the neutral is still connect to UPS.

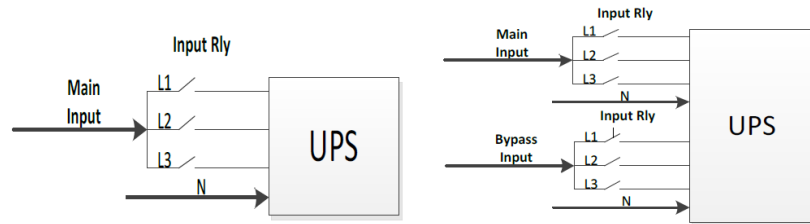

- This UPS should be connected with TN grounding/earthing system.
- The power input for this unit must be three-phase rated in accordance with the equipment nameplate. It also must be suitably grounded.

⚠ WARNING

High leakage current!

Earth connection essential before connecting supply!

- Use of this equipment in medical instrument of any life-sustaining equipment where failure of this equipment can reasonably be expected to cause the failure of the life-sustaining equipment or to significantly affect its safety or effectiveness is not recommended. Do not use this equipment in the presence of a flammable mixture with air, oxygen or nitrous oxide.
- Connect grounding terminal of UPS to a grounding electrode conductor.
- In accordance with safety standard EN-IEC 62040-1, installation has to be provided with a «Backfeed Protection» system, as for example a contactor, which will prevent the appearance of voltage or dangerous energy in the input mains during a mains fault (see figure 24 and respect the wiring diagram of «Backfeed Protection» depending if the equipment is with signal or three phase input).

NOTE!

There can be no derivation in the line that goes from the «Backfeed Protection» to the UPS, as the standard safety would be infringed.

- Warning labels should be placed on all primary power switches installed in places away from the unit to alert the electrical maintenance personnel of the presence of a UPS in the circuit. The label will bear the following or an equivalent text:

Before working on this circuit

1. Isolate Uninterruptible Power Supply (UPS)
2. Then check for Hazardous Voltage between all terminals including the protected earth.

⚠ Risk of Voltage Backfeed

1.5. Operation

- Do not disconnect the grounding/earthing conductor cable on the UPS or the building wiring terminals under any circumstance.
- The UPS system features its own, internal current source (batteries). The UPS output sockets or output terminal blocks may be electrically live even if the UPS system is not connected to the building mains/live wires . (only for standard models).
- In order to fully disconnect the UPS system, first press the “OFF” button and then disconnect the mains/live wires .
- Ensure that no liquid or other foreign objects can enter into the UPS system.
- The UPS can be operated by any individuals with no previous experience.

1.6. Standards

*Safety	
IEC/EN 62040-1	
*EMI	
Conducted Emission.....:IEC/EN 62040-2	Category C3
Radiated Emission.....:IEC/EN 62040-2	Category C3
*EMS	
ESD.....:IEC/EN 61000-4-2	Level 4
RS.....:IEC/EN 61000-4-3	Level 3
EFT.....:IEC/EN 61000-4-4	Level 4
SURGE.....:IEC/EN 61000-4-5	Level 4
CS.....:IEC/EN 61000-4-6	Level 3
Power-frequency Magnetic field.....:IEC/EN 61000-4-8	Level 4
Low Frequency Signals.....:IEC/EN 61000-2-2	

⚠ WARNING

This is a product for commercial and industrial application in the second environment installation restrictions or additional measures may be needed to prevent disturbances.



2 Installation and operation

2.1. Unpacking and inspection

Unpack the package and check the package contents. The shipping package should contain:

- One UPS
- One user manual
- One monitoring software CD
- One RS-232 cable (option)
- One USB cable
- One parallel cable (only available for parallel model)
- One shared current cable (only available for parallel model)

NOTE!

Before the installation, please inspect the unit. Be sure that there is no physical damage to the unit. Do not turn on the unit and notify the carrier and dealer immediately if there is any damage or missing parts and accessories. Please keep the original packaging for future use. It is recommended to keep each equipment and battery set in their original packaging because they have been designed to provide maximum protection during transportation and storage.

2.2. Wiring terminal view

- 1 RS-232 communication port
- 2 USB communication port
- 3 Emergency power off function connector (EPO connector)
- 4 Share current port (only available for parallel model)
- 5 Parallel port (only available for parallel model)
- 6 Intelligent slot
- 7 External battery connector/terminal (Only available for long-run model)
- 8 Line input circuit breaker/switch
- 9 Maintenance bypass switch (option)
- 10 Input/Output terminal (Refer to diagram 2, 5 and 8 for the details)
- 11 Line input terminal
- 12 Output terminal
- 13 Input grounding terminal
- 14 Output grounding terminal
- 15 Bypass input circuit breaker/switch
- 16 Bypass input terminal
- 17 Grounding terminal
- 18 Output switch

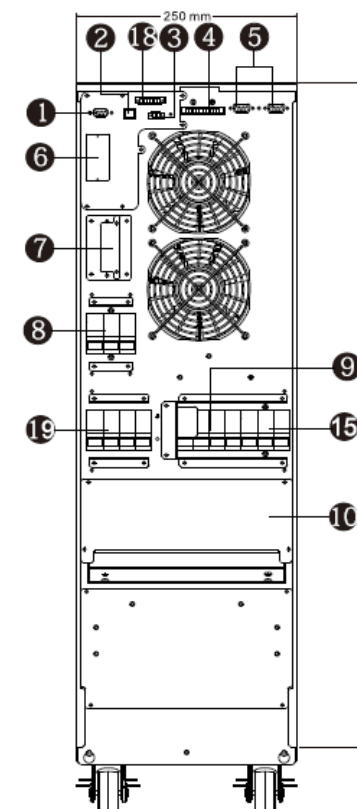

Diagram 1: Garun 10KL, 15KL, 20KL
Dual Rear panel

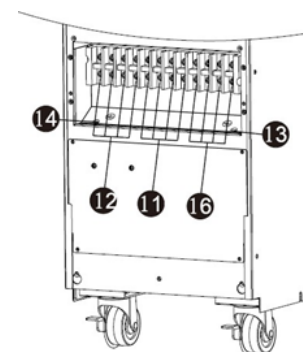

Diagram 2: Garun 10KL, 15KL, 20KL
Dual Input / Output terminal



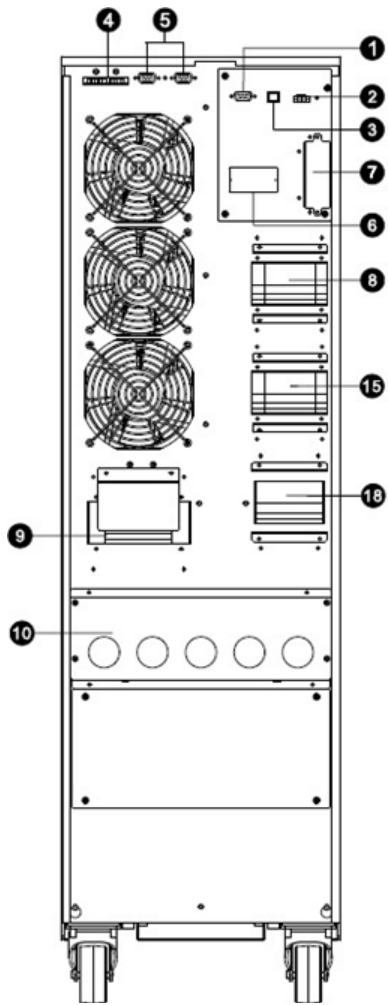

Diagram 3: Garun 30KL
Rear panel

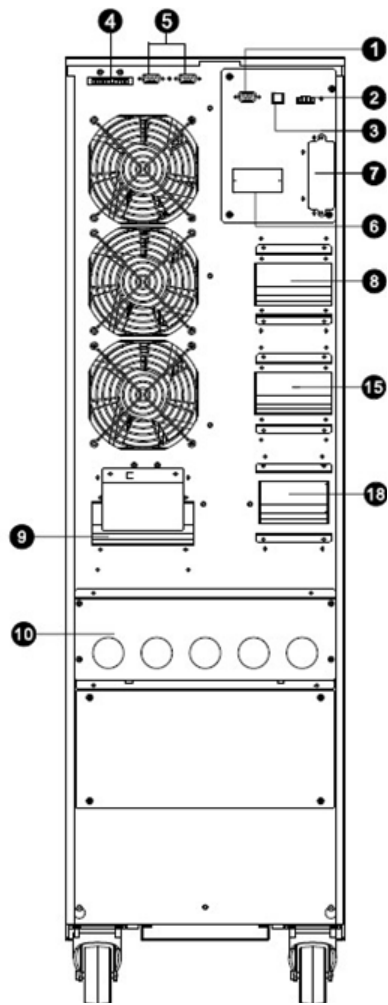

Diagram 4: Garun 40KL
Rear panel

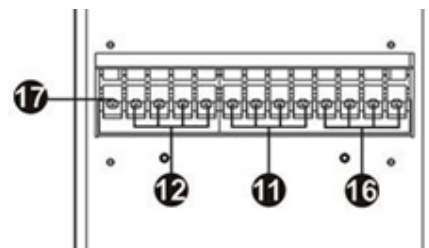

Diagram 5: Garun 30KL, 40KL
Dual Input / Output terminal

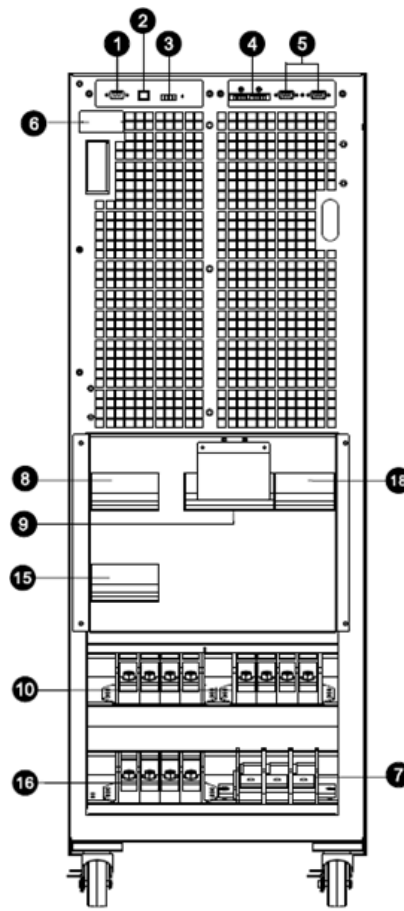

Diagram 6: Garun 60KL
Front view with door open

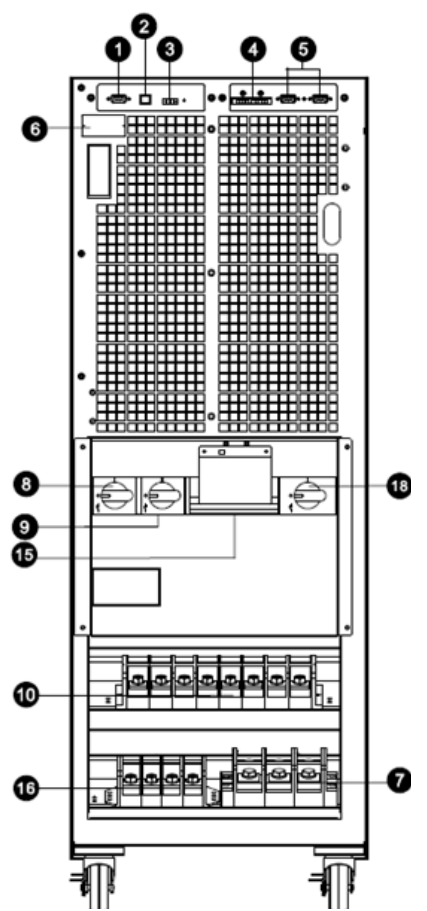

Diagram 7: Garun 80KL
Front view with door open

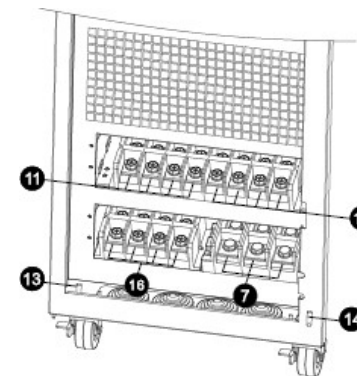

Diagram 8: Garun 60KL, 80KL
Dual Input / Output terminal



2.3. Single UPS installation

Installation and wiring must be carried out in accordance with the local electric laws and regulations by trained professionals.

Step 1. Make sure that the mains wire and breakers of the building are rated for the capacity of the UPS to prevent electric shock or risk of fire.

NOTE!

Do not use the wall receptacle as the input power source for the UPS, as its rated current is less than the UPS's maximum input current. The receptacle may be damaged and destroyed.

Step 2. Switch off the mains switch in the building before installation.

Step 3. Turn off all the connected devices before connecting to the UPS.

Step 4. Prepare wires based on the following table:

Model	Wiring spec (AWG)				
	Input (Ph)	Output (Ph)	Neutral	Battery	Ground
Garun 10KL	14	14	10	8	8
HV 15K	12	12	10	-	8
Garun 30KL	8	8	4	4	4
Garun 40KL	6	6	4	4	4
Garun 60KL	4	4	1	1	4
Garun 80KL	2	2	1/0	1/0	2

- The cable for **Garun 10KL** should be able to withstand over 20A current. It is recommended to use **AWG 14** or thicker wire for Phase and **AWG10** or thicker wire for Neutral for safety and efficiency.

- The cable for **Garun 15KL** should be able to withstand over 30A current. It is recommended to use **AWG 12** or thicker wire for Phase and **AWG10** or thicker wire for Neutral for safety and efficiency.

- The cable for **Garun 20KL** should be able to withstand over 40A current. It is recommended to use **AWG10** or thicker wire for Phase and **AWG 6** or thicker wire for Neutral for safety and efficiency.

- The cable for **Garun 30KL** should be able to withstand over 60A current. It is recommended to use **AWG 8** or thicker wire for Phase and **AWG 4** or thicker wire for Neutral for safety and efficiency.

- The cable for **Garun 40KL** should be able to withstand over 80A current. It is recommended to use **AWG 6** or thicker wire for Phase and **AWG 4** or thicker wire for Neutral for safety and efficiency.

- The cable for **Garun 60KL** should be able to withstand over 120A current. It is recommended to use **AWG 4** or thicker wire for Phase and **AWG 1** or thicker wire for Neutral for safety and efficiency.

- The cable for **Garun 80KL** should be able to withstand over 160A current. It is recommended to use **AWG 2** or thicker wire for Phase and **AWG 1/0** or thicker wire for Neutral for safety and efficiency.

- The selections for color of wires should be followed by the local electrical laws and regulations.

Step 5. Remove the terminal block cover at the rear panel of UPS. Then connect the wires according to the following terminal block diagrams: (Connect the grounding/earthing wire first when making wire connections. Disconnect the earth wire after you disconnect the power wire.)

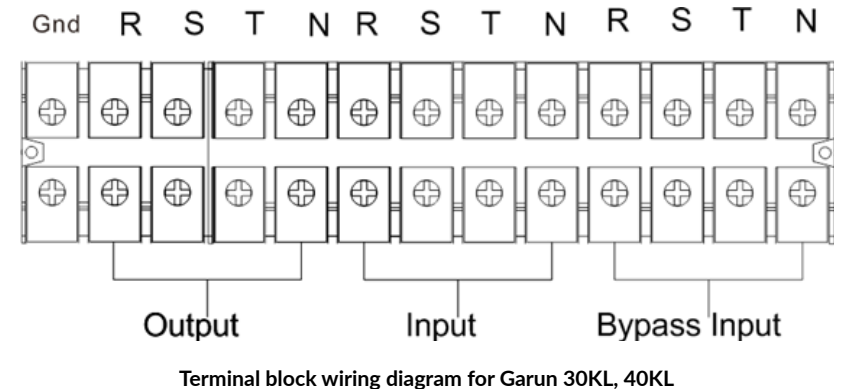
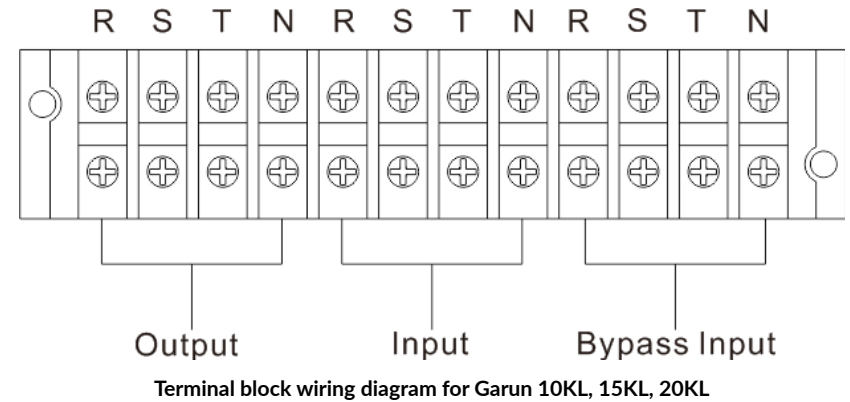

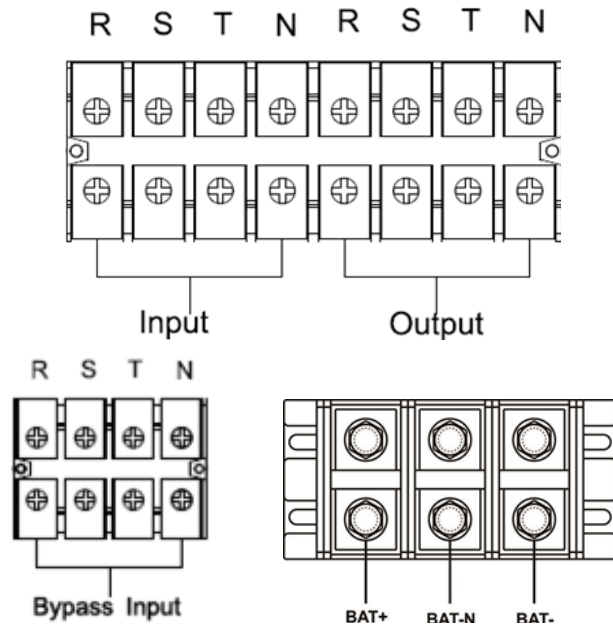

Terminal block wiring diagram for Garun 60KL, 80KL

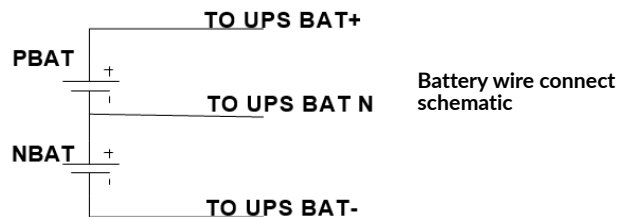

- Make sure that the wires are connected tightly with the terminals.
- Please install the output breaker between the output terminal and the load, and the breaker should be qualified with leakage current protective function if necessary.

Step 6. Put the terminal block cover back at the rear panel of the UPS.

IMPORTANT!

- Make sure a DC breaker or other protective device between UPS and the external battery pack is installed. If not, please install it carefully. Switch off the battery breaker before installation.



- Set the battery pack breaker in “OFF” position and then install the battery pack.
- Pay high attention to the rated battery voltage marked on the rear panel. If you want to change the numbers of the battery pack, please make sure you modify the setting simultaneously. The connection with wrong battery voltage may cause permanent damage of the UPS. Make sure the voltage of the battery pack is correct.
- Pay high attention to the polarity marking on external battery terminal block. And make sure the correct battery polarity is connected. Wrong connection may cause permanent damage of the UPS.
- Make sure the protective earth ground wiring is correct. The wire current spec, color, position, connection and conductance reliability should be checked carefully.
- Make sure the utility input & output wire is correct. The wire current spec, color, position, connection and conductance reliability should be checked carefully. Make sure the L/N side is correct, not reverse or short-circuited.

2.4. UPS installation for parallel system

If the UPS is only available for single operation, you may skip this section to the next.

- Step 1.** Install and wires the UPS according to the section 2-3.
- Step 2.** Connect the output wires of each UPS to an output breaker.
- Step 3.** Connect all output breakers to a major output breaker. Then this major output breaker will directly connect to the loads.
- Step 4.** Common battery packs or independent battery packs are allowed.
- Step 5.** Refer to the following wiring diagram:

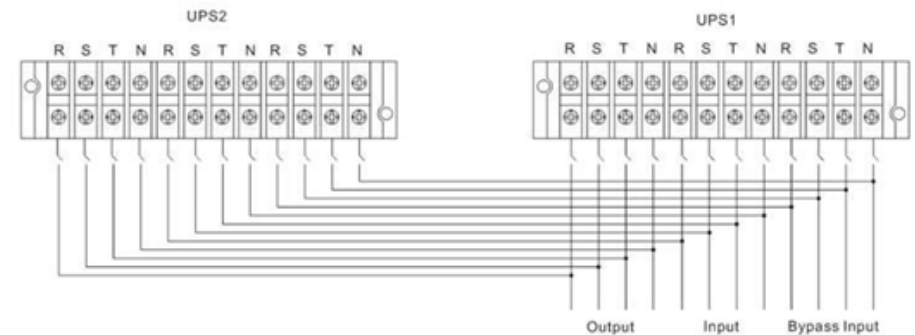

Wiring diagram of parallel system for Garun 10KL, 15KL, 20KL



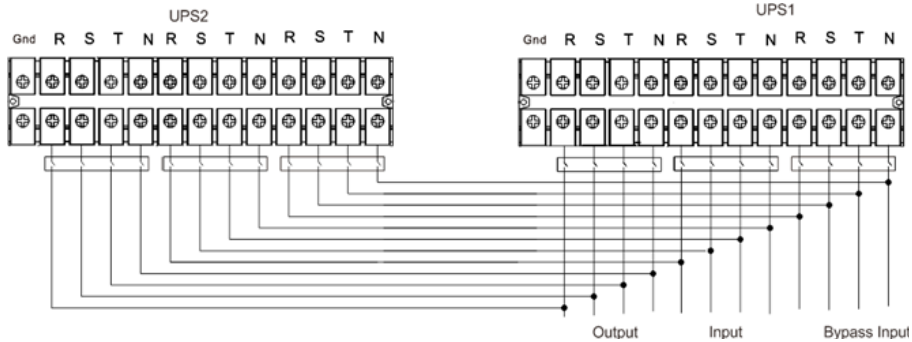

Wiring diagram of parallel system for Garun 30KL, 40KL

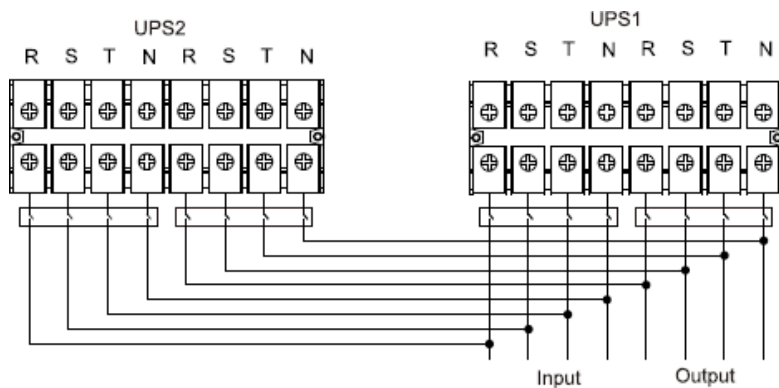

Wiring diagram of parallel system for Garun 60KL, 80KL

2.5. Software installation

For optimal computer system protection, install UPS monitoring software from <https://www.power-software-download.com/viewpower.html>.

3 Operations

3.1. Initial operation

Step 1. Before operation, make sure that the two strings of batteries are connected correctly in order of "+,GND,-" terminals and the breaker of the battery pack is at "ON" position (only for long-run model).

Step 2. Press the **POWER** button to set up the power supply for the UPS. UPS will enter to power on mode. After initialization, UPS will enter to "No Output mode".

3.2. Screen description

After initialization, the LCD will display main screen.

There are five sub-menus: Control, measure, setting, information and data log. Touch any sub-menu icon to enter into the sub-screen.

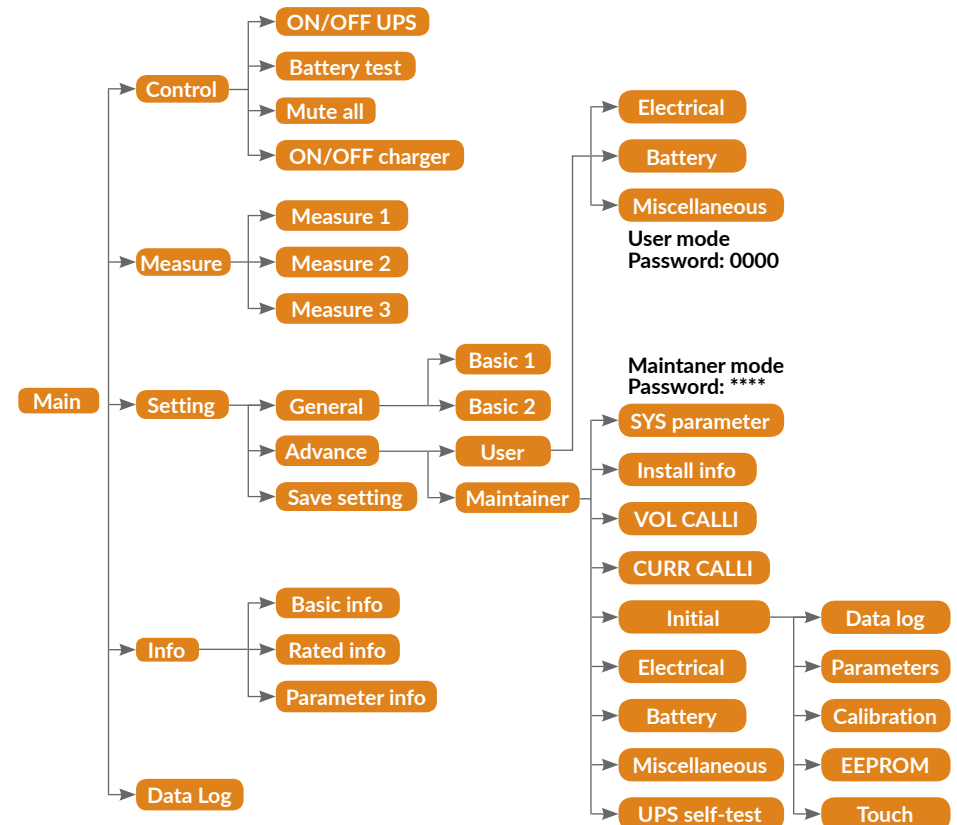

3.2.1. Main screen

Upon powering on, the LCD will start initialization approximately few seconds.

After initialization, the main screen will display as shown below. On the bottom, there are five icons to represent five sub-menus: CONTROL, MEASURE, SETTING, INFO, DATALOG.

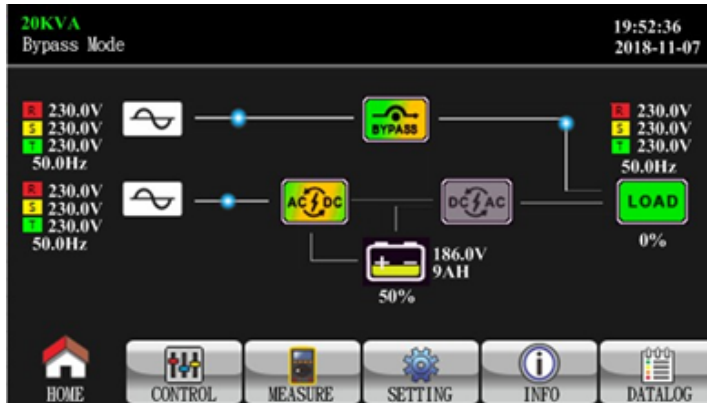

Main screen

3.2.2. Control screen

Touch the icon  to enter control sub-menu.

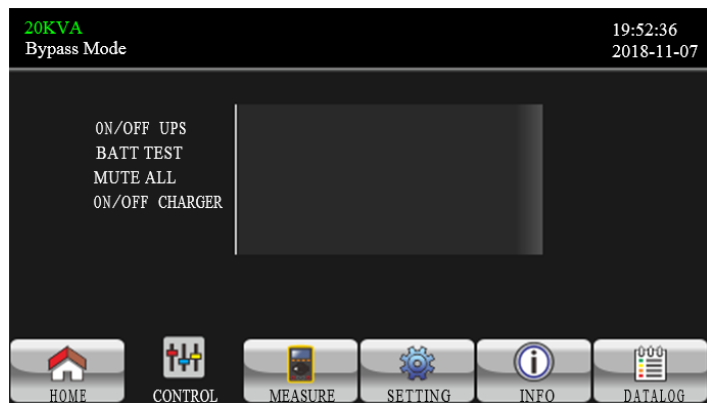

Control screen

Touch the  icon to return back to main screen no matter it's in any screen of any submenu.

ON/OFF UPS

It will show “Turn on UPS?” when UPS is off.

It will show “Turn off UPS?” when UPS is on.

Touch “YES” to turn on or off the UPS. Then, the screen will return to main screen.

Touch “Back” to return to main screen immediately or “No” to cancel this operation and back to main screen.

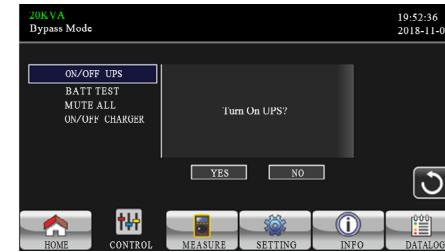

Turn on UPS

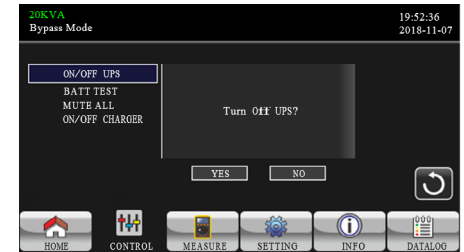

Turn off UPS

Battery test

It will show “Battery Test” if the UPS is not in test. Touch “Yes” to start battery test. Then, it will show “Battery testing....” during battery test period.

After few seconds, battery test result will show on the screen. Touch “Back” to return to main screen immediately or “No” to cancel this operation and back to main screen. It will show “Cancel battery test” if the UPS is in test.

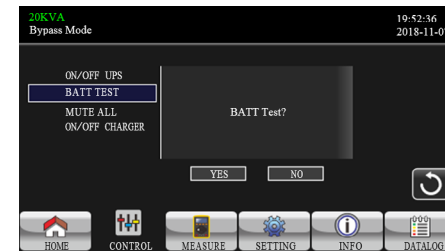

Battery Test

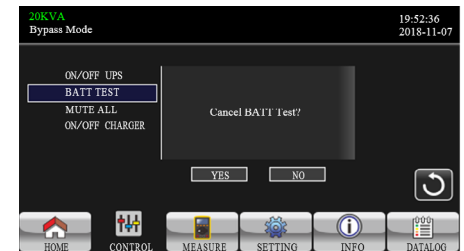

Cancel Battery Test



Audio mute

It will show “Mute all” if the audio is active. Touch “Yes” to activate mute. If “Mute all” is active, it will show  icon on the top left corner of the main

screen. Touch “Back” to return to CONTROL screen immediately or “No” to cancel this operation and back to CONTROL screen.

It will show “Cancel Mute All” if the UPS is mute already. Touch “Yes” activate audio function or “No” to keep mute. Touch “Back” to return to CONTROL screen.



Mute All

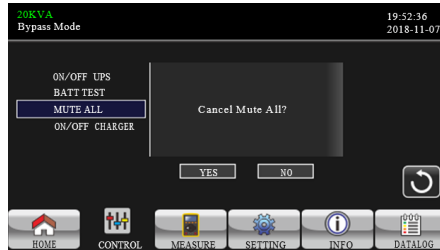

Cancel Mute All

ON/OFF Charger

It will show “Turn on Charger?” when charger is off.

It will show “Turn off Charger?” when charger is on.

Touch “YES” to turn on or off the charger. Then, the screen will return to main screen.

Touch “Back” to return to CONTROL screen immediately or “No” to cancel this operation and back to CONTROL screen.

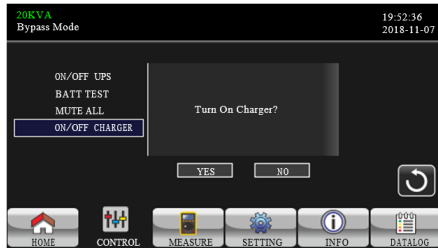



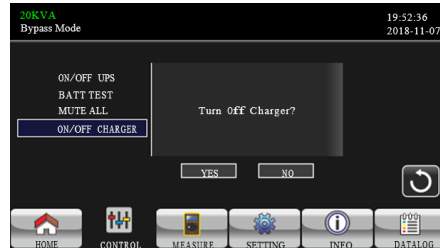

Turn on Charger



Turn off Charger

3.2.3. Measure screen

Touch the icon  to enter measure page. Touch the icon  or  to browse information. Touch the icon  to return to main screen. Touch the

icon  to go back to previous menu.



Measure screen page 1

LINE VOL: The real time value of R, S and T phase voltage, RS, ST, TR voltage and input frequency.

INVERTER VOL: The real time value of R, S and T inverter voltage, RS, ST and TR voltage and frequency.

BYPASS VOL: The real time value of R, S and T bypass voltage, RS, ST and TR voltage and frequency.

OUTPUT VOL: The real time value of R, S and T output voltage, RS, ST and TR voltage and frequency

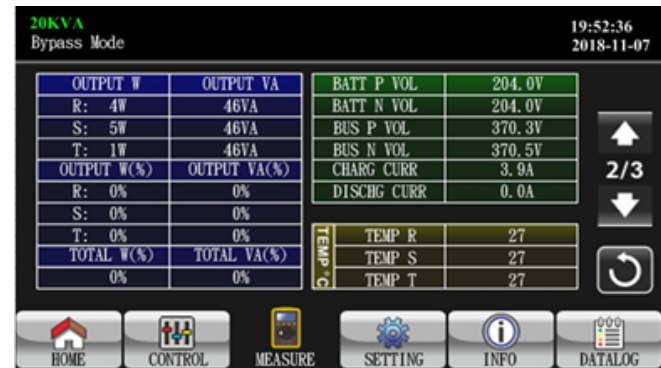

Measure screen page 2

OUTPUT W: R, S and T output power in watt.

OUTPUT VA: R, S and T output power in VA.

OUTPUT W (%): R, S and T output power watt in percentage.

OUTPUT VA (%): R, S and T output power VA in percentage.

Total watt and VA: Total output load in watt and VA.

BATT Voltage/Bus Voltage/Charging Current/Discharging Current: The real time value of DC related information.

Temperature: Temperature of R, S and T phases.

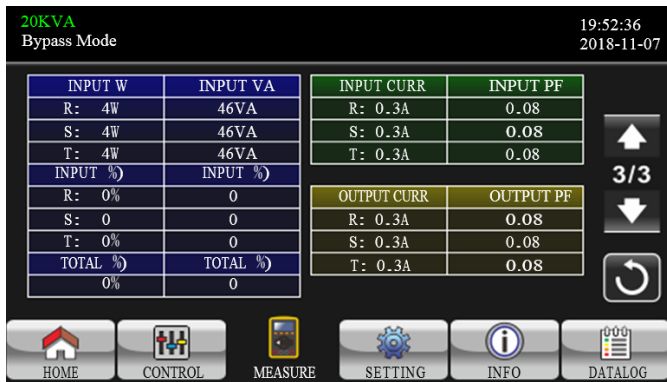

Measure screen page 3

INPUT W: R, S and T input power in watt.

INPUT VA: R, S and T input power in VA.



INPUT W (%): R, S and T input power watt in percentage.

INPUT VA (%): R, S and T input power VA in percentage.

Input current: The real-time value of input current in R, S and T phases.

Output current: The real-time value of output current in R, S and T phases.

3.2.4. Setting screen

This sub-menu is used to set the parameters of UPS. Touch the icon  to enter setting menu page. There are 2 options: Basic and Advanced. Touch the icon  to return to main screen. Touch the icon  to go back to previous menu.

NOTE!

Not all settings are available in every operation mode. If the setting is not available in present mode, the LCD will keep its original setting parameter showed instead of changing the parameters.



Setting Menu

GENERAL: It's to set up basic information of the UPS. It's not related to any function parameter.

ADVANCE: It's required to enter password to access to the "ADVANCE" setting. There are two types of authority, User and Maintainer.

SAVE SETTING: This function is reserved for future.

General

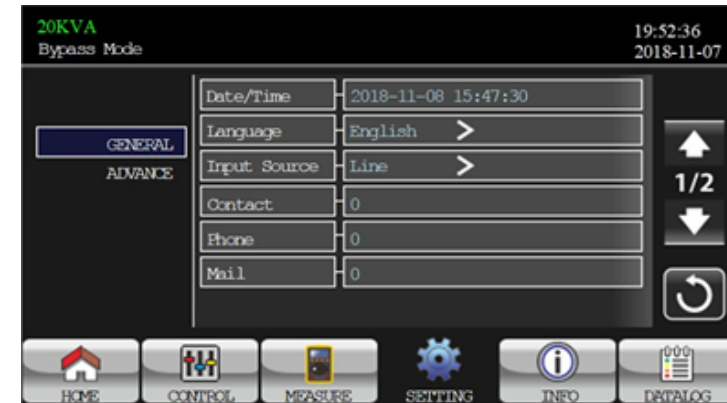

General Setting page 1

Date/Time: Set the date and time. The format is YYYY-MM-DD HH:MM:SS. The calendar day will be automatically changed when the year, month and date are set.

Language: Set the LCD language.

Input Source: Select the input source. There are two options: Line (utility) and generator. Line is default setting. This setting value will show on the main page. When "generator" is selected, the acceptable input frequency will be fixed at the range of 40~70Hz. This setting value will show on the status bar.

Service Contact: Set the name of contact person and the maximum length is 18 characters.

Service Phone: Set the service phone number. Only 0~9, + and - are accepted. The maximum length is 14 characters.

Service Mail: Set the service email accounts up to two and the maximum length is 36 characters.







General Setting page 2

Audio Alarm: There are two events available to mute. You may choose “Enable” or “Disable” alarm when related events occur.

Enable: When selected, alarm will be mute when related events occur.

Disable: When selected, UPS will alarm when related events occur.

All Mute: When “enable” is selected, all the faults and warnings will be mute. It will show  icon on the top right corner of the main screen.

Mode Mute: UPS status mode alarm enable/disable. If “Mode Mute” is activated, it will show  icon on the top right corner of the main screen.

Advance

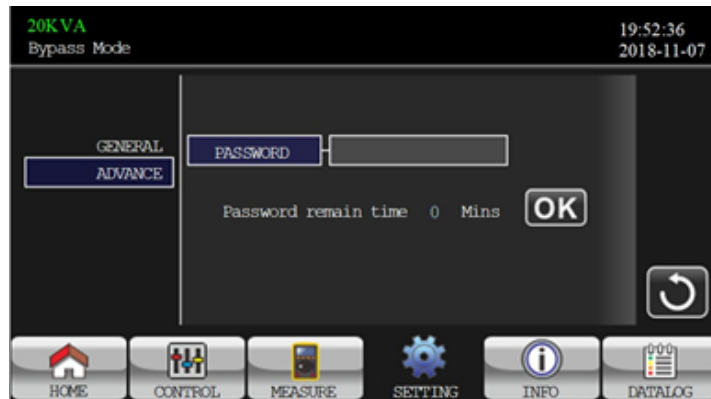

Advance Password Page

It's required to enter password (4 digits) to access to the “ADVANCE” page.

Advance - User

To access “Advance-User” settings menu page, the default password is “0000”. If entered password is right, the page will jump to setting screen. If the password is wrong, it will ask to enter again.



Password error page

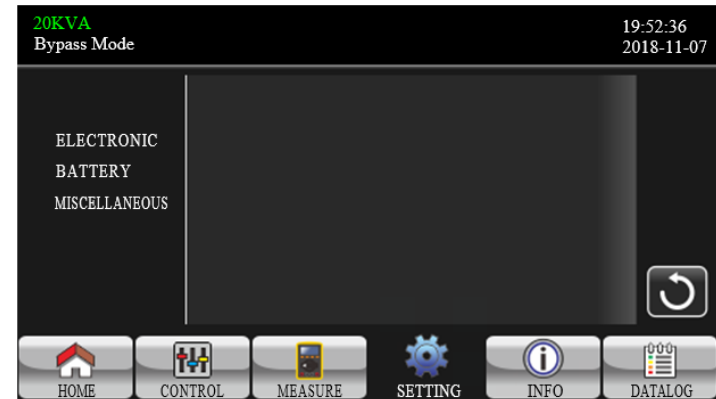

Advance Setting Menu Page

There are three sub-menus under “Advance ► User” setting: ELECTRONIC, BATTERY and MISCELLANEOUS.



• **ELECTRONIC**



Electronic Menu Page

Output Voltage: Select the output rated voltage. There are four options, 208V, 220V, 230V and 240V.

Output Frequency: Select output rated frequency.
 50Hz: The output frequency is setting for 50Hz.
 60Hz: The output frequency is setting for 60Hz.

CVCF Mode (constant voltage and constant frequency function)
 Enable: CVCF function is enabled. The output frequency will be fixed at 50Hz or 60Hz according to setting of "OP Freq.". The input frequency could be from 46Hz to 64Hz.
 Disable: CVCF function is disabled. The output frequency will synchronize with the bypass frequency within 46~54 Hz for 50Hz system or within 56~64 Hz for 60Hz system. Disable is the default setting.

Bypass Forbid:
 Enable: Bypass forbid is enabled. When selected, it's not allowed for running in Bypass mode under any situations.
 Disable: Bypass forbid is disabled. When selected, UPS will run in Bypass mode depending on "Bypass at UPS off" setting. It is the default setting.

Bypass at UPS off: Select the bypass status when manually turning off the UPS. This setting is only available when "Bypass forbid." is set to "Disable".
 Enable: Bypass enabled. When selected, bypass mode is activated.
 Disable: Bypass disabled. When selected, no output through bypass when manually turning off the UPS.

Bypass Voltage Range: Set the bypass voltage range.
 L: Low voltage point for bypass. The setting range is 176V ~ 209V.
 H: High voltage point for bypass. The setting range is 231V ~ 264V.

Bypass FREE Range: Set the bypass frequency range.
 The acceptable bypass frequency range from 46Hz to 54Hz when UPS is 50Hz system and from 56Hz to 64Hz when UPS is 60Hz system.

ECO mode: Enable/Disable ECO mode. Default setting is "Disable".

ECO Voltage Range: Set the ECO voltage range.
 L: Low voltage point for ECO mode. The setting range is from "Rated output voltage - 5V" to "Rated output voltage - 11V". "Rated output voltage - 5V" is default setting.
 H: High voltage point for ECO mode. The setting range is from "Rated output voltage + 5V" to "Rated output voltage + 11V". "Rated output voltage + 5V" is default setting.

ECO FREE Range: Set the ECO frequency range. The setting range is from 46Hz to 54Hz when the UPS is 50Hz system and from 56Hz to 64Hz when the UPS is 60Hz system.

• **Battery**



Battery setting page

Battery Warning Voltage:
 HIGH: High battery warning voltage. The setting range is 14.0V ~ 15.0V. 14.4V is default setting.
 LOW: Low battery warning voltage. The setting range is 10.1V ~ 14.0V. 11.4V is default setting. This parameter setting is related to "Shutdown Voltage" setting. This setting value should be higher than "Shutdown Voltage" setting.

Shutdown Voltage: If battery voltage is lower than this point in battery mode, UPS will automatically shut down. The setting range is 10.0V ~ 12.0V. 10.7V is default setting. (The setting is only available for long-run model)



Battery Parameter:

Battery AH: setting battery capacity.

• Miscellaneous

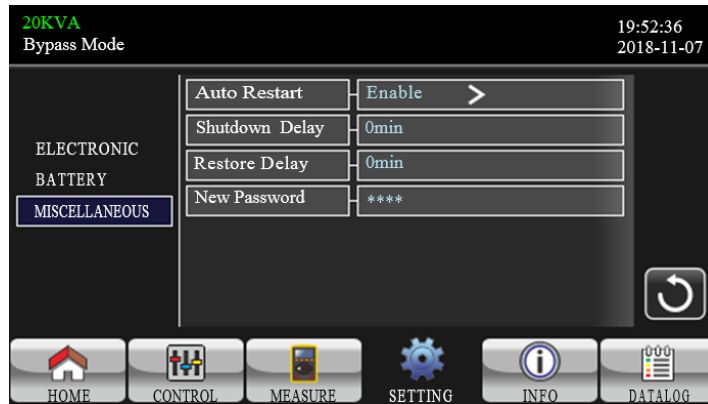

Miscellaneous setting page

Auto Restart: (This function is reserved for future use)

Enable: After “Enable” is set, once UPS shutdown occurs due to low battery and then utility restores, the UPS will return to line mode.

Disable: After “Disable” is set, once UPS shutdown occurs and the utility restores, the UPS will not automatically turn on

Shutdown Delay Min: UPS will shut down in setting minutes. The countdown will start after confirming the pop-up screen.

Restore Delay Min: UPS will automatically restart in setting minutes after the UPS shuts down.

New Password: Set up new password to enter “ADVANCE ► User” menu.

Advance - Maintainer

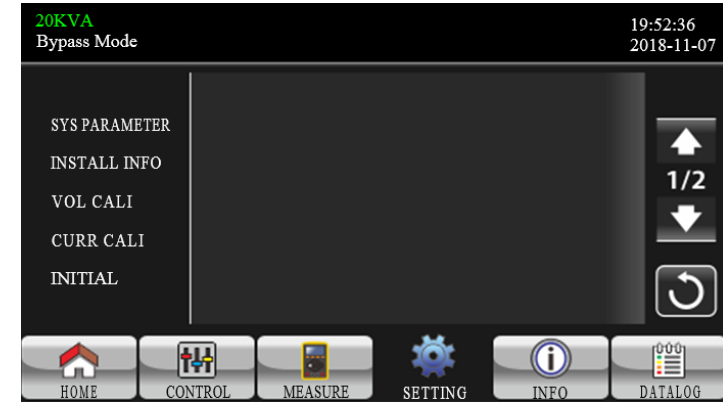

Advance: Maintainer Setting Menu Page1

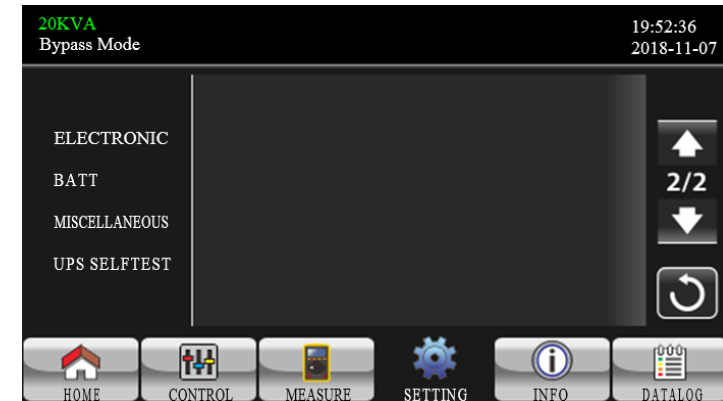

Advance: Maintainer Setting Menu Page2

To access the “Advance-Maintainer” Setting menu page, it’s required to enter password. Please contact your local dealer to get maintainer password.

NOTE!

This setting menu is only for qualified technician. Otherwise, mis-operation will cause UPS damage.

There are nine sub-menus under “Advance ► Maintainer” setting: SYS PARAMETER, INSTALL INFO, VOL CALI, CURR CALI, INITIAL, ELECTRONIC, BATT, MISCELLANEOUS and UPS SELFTEST.



• **SYS Parameter**



SYS Parameter page 1

- Mode Name:** Set the UPS model name.
- Serial Number:** Set the serial number.
- Manufacturer:** Set the UPS manufacturer.
- Charger Number:** The number of charging boards installed in the UPS

NOTE!
It's required to restart the UPS after setting.

- Max Charge Current:**
 - One piece of charger: There are twelve options, 1A/2A/3A/4A/5A/6A/7A/8A/9A/10A/11A/12A.
 - Two pieces of charger: There are twelve options, 2A/4A/6A/8A/10A/12A/14A/16A/18A/20A/22A/24A

BATT Number: The total number of installed battery. (It should be restart UPS after setting.) The setting range is 16 ~ 20. 16 is default setting.

Float VOL: The setting point of battery float voltage. 13.6V is default setting.

UPS Type: There are two options, HV and LV. This change is only allowed for qualified technician.

NOTE!
It's required to restart the UPS after setting.

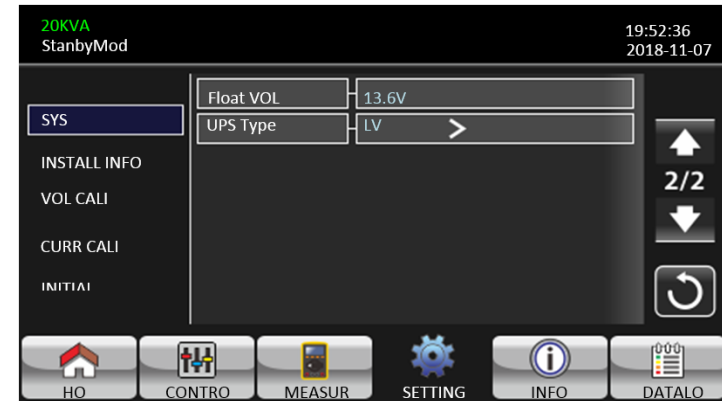

SYS Parameter page 2

• **Install info**

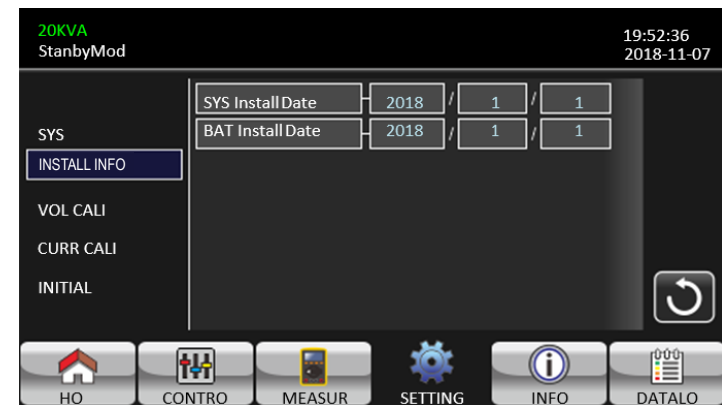

INSTALL INFO Page

- SYS Install Date:** Set the date of UPS installation.
- BAT Install Date:** Set the date of Battery installation.



• VOL CALI

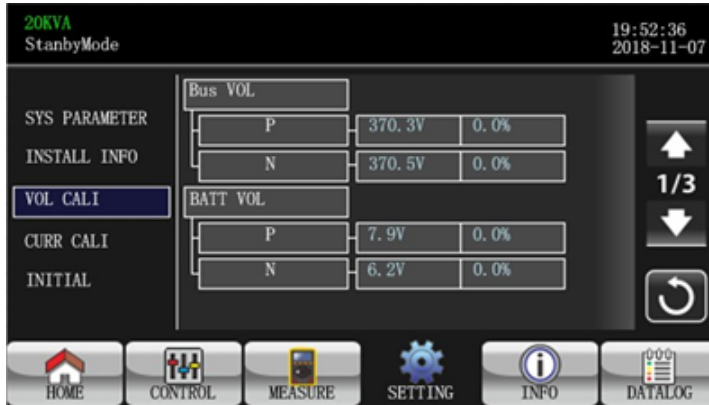

VOL CALI Page1

Bus VOL: BUS voltage calibration.
BATT VOL: Battery voltage calibration.

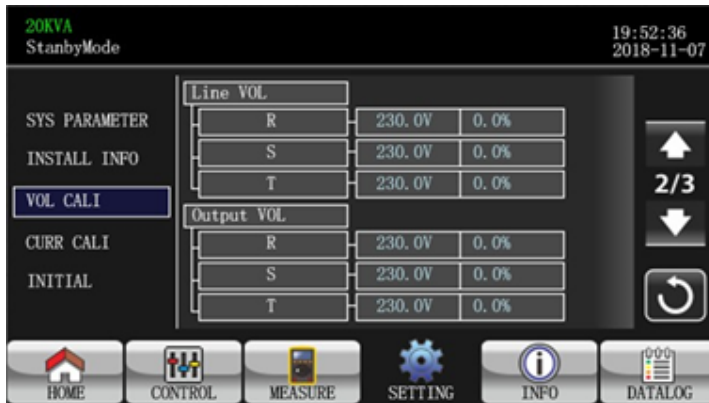

VOL CALI Page2

Line VOL: Line voltage calibration.
Output VOL: Output voltage calibration.

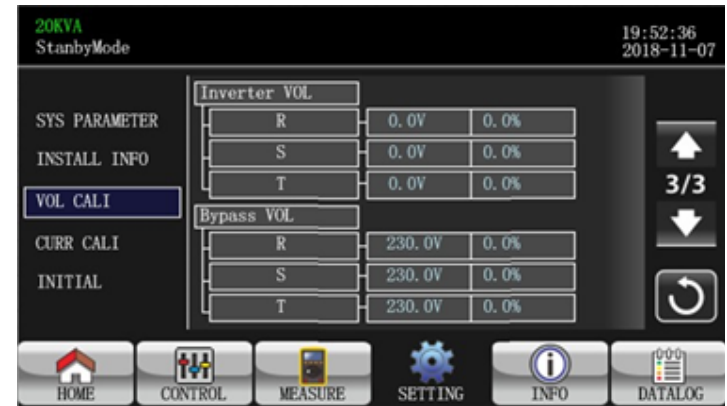

VOL CALI Page3

Inverter VOL: Inverter voltage calibration.
Bypass VOL: Bypass voltage calibration.

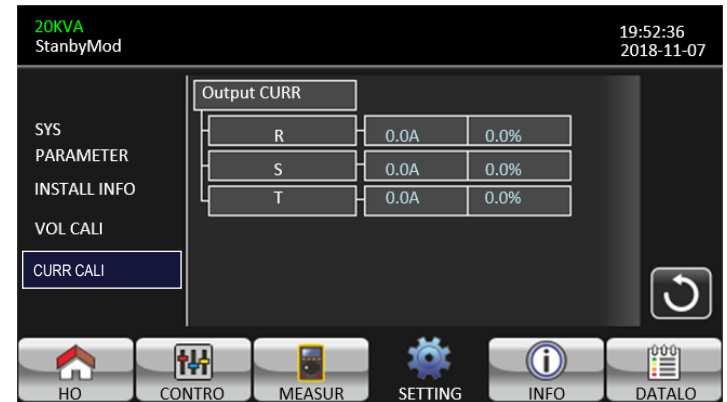

• CURR CALI



CURR CALI Page

Output CURR: Output current calibration.

NOTE!

Each click is 0.1% no matter it's pressing up or down key   
Press "up" key to increase 0.1% and press "down" key to decrease 0.1%.
Press "OK" key to confirm the modification.



• Initial



INITIAL menu page

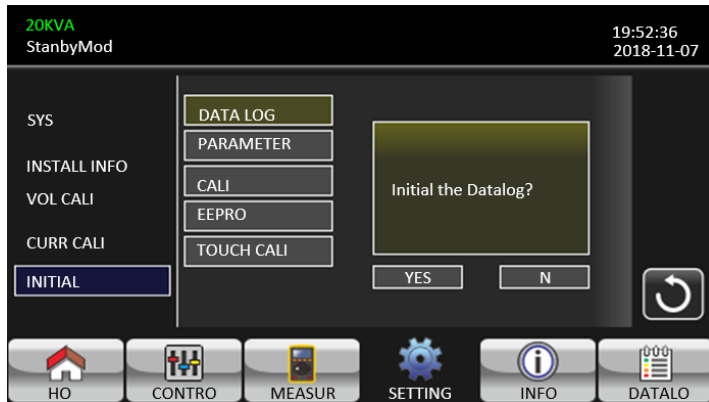

INITIAL DATALOG page

DATALOG: After pressing, the confirmation window, it will pop up as shown in above screen. Touch “YES” to clear the DATALOG page. Touch “Back” or “No” to cancel this operation and back to INITIAL menu page.

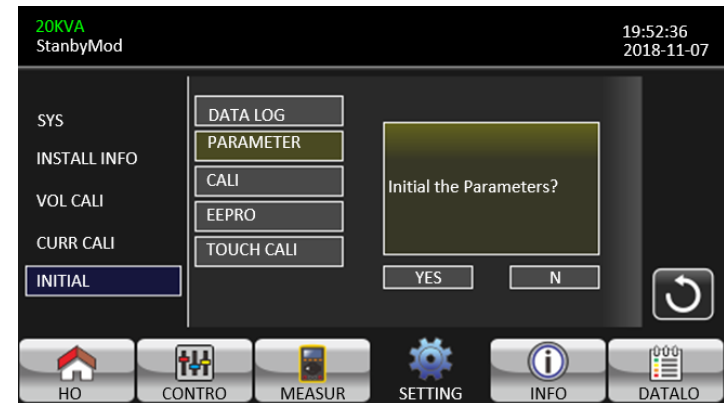

INITIAL PARAMETERS page

PARAMETERS: After pressing the confirmation window, it will pop up as shown in above screen. Touch “YES” to restore default value. Touch “Back” or “No” to cancel this operation and back to INITIAL menu page.

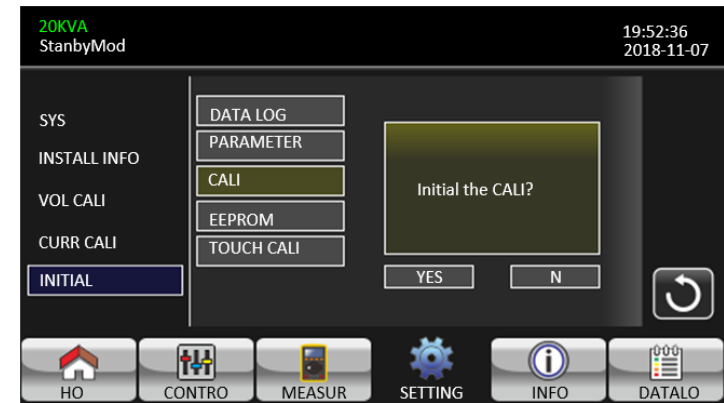

INITIAL CALI page

CALI: After pressing the confirmation window, it will pop up as shown in above screen. Touch “YES” to restore default calibration value. Touch “Back” or “No” to cancel this operation and back to INITIAL menu page.



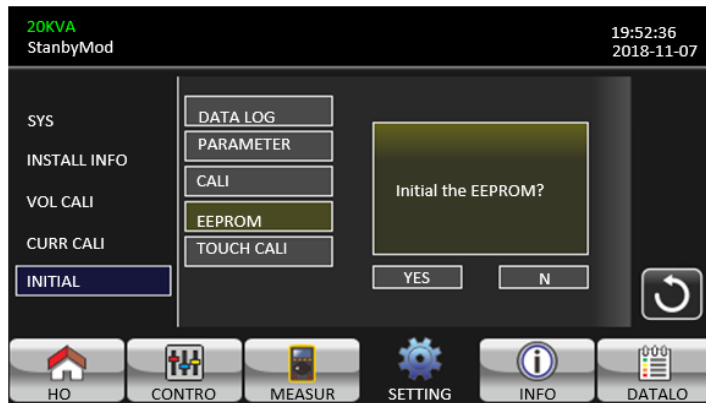

INITIAL EEPROM page

EEPROM: After pressing the confirmation window, it will pop up as shown in above screen. Touch “YES” to clear all setting value in EEPROM. Touch “Back” or “No” to cancel this operation and back to INITIAL menu page.



INITIAL TOUCH page

TOUCH CALI: After pressing the confirmation window, it will pop up as shown in above screen. Touch screen to recalibrate. Then, the blue screen appears and please touch the place where white cross is located.

• ELECTRONIC



Electronic Setting page 1

Output Voltage: Select the output rated voltage. There are four options: 208V, 220V, 230V and 240V.

Output Rated FRE: Select output rated frequency.
 50Hz: The output frequency is setting for 50Hz.
 60Hz: The output frequency is setting for 60Hz.

CVCF Mode: Constant voltage and constant frequency function.
 Enable: CVCF function is enabled. The output frequency will be fixed at 50Hz or 60Hz according to setting of “Output Freq.”. The input frequency could be from 46Hz to 64Hz.
 Disable: CVCF function is disabled. The output frequency will synchronize with the bypass frequency within 46~54 Hz for 50Hz system or within 54~64 Hz for 60Hz system. Disable is the default setting.

Bypass Forbid:
 Enable: Bypass Forbid is enabled. It's not allowed for running in Bypass mode under any situations.
 Disable: Bypass Forbid is disabled. UPS will run in Bypass mode. It is the default setting.



Electronic Setting page 2

Bypass at UPS off: Select the bypass status when manually turning off the UPS. This setting is only available when “Bypass forbid” is set to “Disable”.

Enable: Bypass enabled. When selected, bypass mode is activated.

Disable: Bypass disabled. When selected, no output through bypass when manually turning off the UPS.

Bypass Voltage Range: Set the bypass voltage range.

L: Low voltage point for bypass. The setting range is 176V ~ 209V.

H: High voltage point for bypass. The setting range is 231V ~ 264V.

Bypass FRE Range: Set the bypass frequency range.

The acceptable bypass frequency range from 46Hz to 54Hz when UPS is 50Hz system and from 56Hz to 64Hz when UPS is 60Hz system.

ECO mode: Enable/Disable ECO mode. Default setting is “Disable”.

ECO Voltage Range: Set the ECO voltage range.

L: Low voltage point for ECO mode. The setting range is from “Rated output voltage - 5V” to “Rated output voltage - 11V”. “Rated output voltage - 5V” is default setting.

H: High voltage point for ECO mode. The setting range is from “Rated output voltage + 5V” to “Rated output voltage + 11V”. “Rated output voltage + 5V” is default setting.

ECO FRE Range: Set the ECO frequency range. The setting range is from 48Hz to 52Hz when the UPS is 50Hz system and from 58Hz to 62Hz when the UPS is 60Hz system.

• Battery



Battery setting page

Battery Warning Voltage:

HIGH: High battery warning voltage. The setting range is 14.0V ~ 15.0V. 14.4V is default setting.

LOW: Low battery warning voltage. The setting range is 10.1V ~ 14.0V. 11.4V is default setting. This parameter setting is related to “Shutdown Voltage” setting. The setting value should be higher than “Shutdown Voltage” setting.

Shutdown Voltage: If battery voltage is lower than this point in battery mode, UPS will automatically shut down.

The setting range is 10.0V ~ 12.0V. 10.7V is default setting (The setting is only available for long-run model)

Battery Parameter:

Battery AH: setting battery capacity.

• Miscellaneous

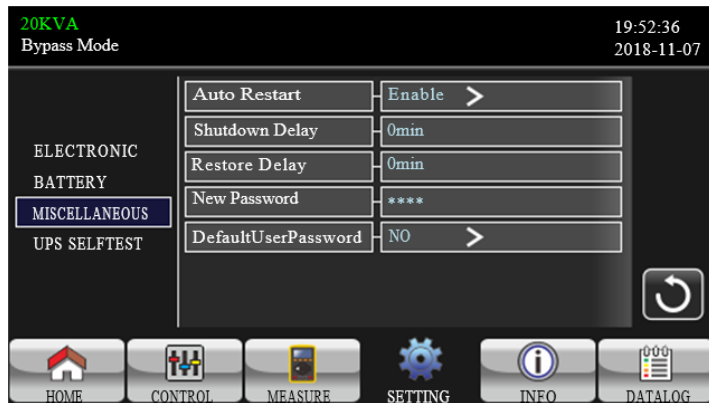

Miscellaneous setting page

Auto Restart:

Enable: After “Enable” is set, once UPS shutdown occurs due to low battery and then utility restores, the UPS will return to line mode.

Disable: After “Disable” is set, once UPS shutdown occurs and the utility restores, the UPS will not automatically turn on.

Shutdown Delay Min: UPS will shut down in setting minutes. The countdown will start after confirming the pop-up screen.

Restore Delay Min: UPS will automatically restart in setting minutes after the UPS shuts down.

New Password: Set up User new password to enter “ADVANCE►User” menu page.

DefaultUserPassword:

YES: After “YES” is set, User password will restore default setting value.

NO: After “NO” is set, the UPS will cancel this operation.



• UPS Selftest

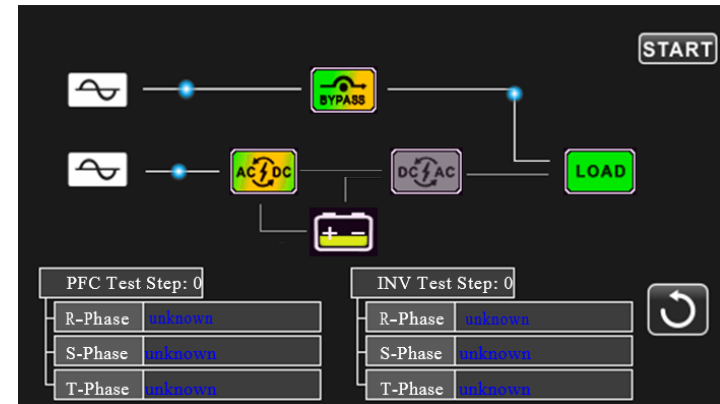

UPS Selftest Page

This function is only effective when UPS type setting is “HV”. Therefore, please disconnect all loads and utility first before executing this function. Then, please change UPS type to “HV”. For the detailed operation, please check “System Parameter” menu under Advance-Maintainer directory.

After changing UPS type to “HV”, you have to restart the UPS. After the UPS is restarted, please enter Advance screen and enter Maintainer password. It will show “UPS SELFTEST” selection in the screen. In the screen, all tested items are shown “unknown”. Simply click “UPS SELFTEST” button, the UPS will start self-test. If the UPS is normal, it will show “Normal” in all columns. Otherwise, “Unknown” will be displayed in the columns.



3.2.5. Information screen

Touch the icon  to enter information page. Touch the icon  or  to browse information. Touch the icon  to return to main screen. Touch the icon  to go back to previous menu.

- Basic information



Basic Information Page1

- MCU Version:** MCU version.
- DSP Version:** DSP version.
- Serial NO.:** The serial number of UPS.
- Manufacturer:** The information about manufacturer.
- Service Contact:** The contact name is set in "Basic Setting".
- Service Phone:** The listed numbers are set in "Basic Setting".
- Service Mail:** The service email account is set in "Basic Setting".



Basic Information Page2

- SYS Install Date:** The date of system installation.
- BAT Install Date:** The date of battery installation.
- PAR State:** The information of parallel state.
- PAR ID:** The UPS ID number in parallel state.
- Input Source:** The information of input source.
- All Mute:** Enable/disable all mute function.
- Mode Mute:** Enable/disable mode mute function.

- Rated information



Rated Information Page

- Output Voltage:** It shows output rated voltage.
- Output FRE:** It shows output rated frequency.
- CVCF Mode:** Enable/Disable CVCF mode.
- Bypass Forbid:** Enable/disable bypass function.
- Bypass UPS Off:** Enable/disable auto bypass function when UPS is off.
- Auto Restart:** Enable/disable auto-restart function.
- ECO Mode:** Enable/disable ECO function.



• Parameter information



Parameter Information Page1

- Line Voltage Range:** The acceptable line input voltage range.
- Line FRE Range:** The acceptable line input frequency range.
- Bypass Voltage Range:** The acceptable input voltage range for bypass mode.
- Bypass FRE Range:** The acceptable input frequency range for bypass mode.
- ECO Voltage Range:** The acceptable input voltage range for ECO mode.
- ECO FRE Range:** The acceptable input frequency range for ECO mode.

BATT Warning Voltage:

- HIGH: High battery warning voltage.
- LOW: Low battery warning voltage.

Shutdown Voltage: If battery voltage is lower this point, UPS will automatically shut down.

Battery Age: It shows battery age.

Battery AH: It shows battery AH

Battery Number: It shows battery number.

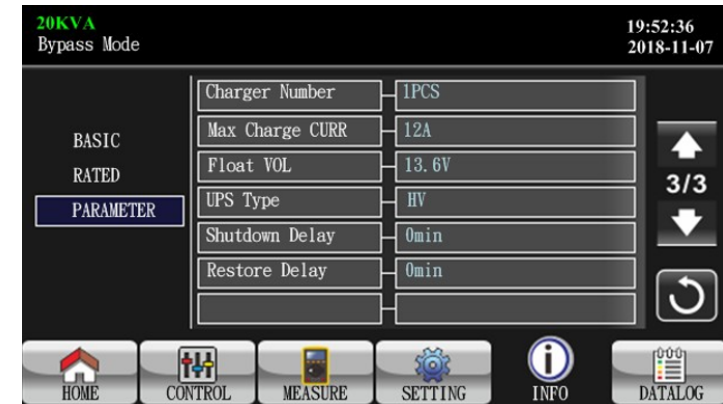

Parameter Information Page3

Charger Number: The information of charger number.

Max Charge CURR: The setting value of the maximum charging current.

Float VOL: The setting value of the battery float voltage.

UPS Type: The information of UPS type.

Shutdown Delay: UPS will shut down in setting minutes. The countdown will start after confirming the pop-up screen.

Restore Delay: UPS will automatically restart in setting minutes after the UPS shuts down.







Parameter Information Page2

BATT Mode Work Time: The maximum discharge time in battery mode.



3.2.6. Data Log screen

Touch the icon  to enter data log page. Data log is used to record the warning and fault information of the UPS. The record contains date & time, code, type and description. Touch the icon  or  to browse information. Touch the icon  to return to main screen. Touch the icon  to go back to previous menu.

Please refer to Section 3-6 and 3-7 for warning and fault code list.



Date Time	CODE	TYPE	Description
2018/11/8 17:02:30	01	Mode	Bypass Mode
2018/11/8 17:02:30	02	Mode	Standby Mode

Data log page

3.3. Audible alarm

Description	Buzzer status	Muted
UPS status		
Bypass mode	Beeping once every 2 minutes	Yes
Battery mode	Beeping once every 4 seconds	
Fault mode	Beeping continuously	
Warning		
Overload	Beeping twice every second	No
Others	Beeping once every second	
Fault		
All	Beeping continuously	Yes

3.4. Single UPS operation

1. Turn on the UPS with utility power (in AC mode)

- After power supply is connected correctly, set the breaker of the battery pack at "ON" position (this step only necessary for long-run model). Then set the line input breaker at "ON" position. At this time the fan is running and the UPS enter to power on mode for initialization, several seconds later, UPS operates in Bypass mode and supplies power to the load via the bypass.

NOTE!

When UPS is in Bypass mode, the output voltage will directly power from utility after you switch on the input breaker. In Bypass mode, the load is not protected by the UPS. To protect your precious devices, you should turn on the UPS.

- Touch "CONTROL" and select "UPS on/off" icon. It will show "Turn on UPS?" in screen and select "Yes". Refer to On/Off UPS screen.
- A few seconds later, the UPS will enter into AC mode. If the utility is abnormal, the UPS will operate in Battery mode without interruption.

NOTE!

When the UPS running out battery, it will shut down automatically at Battery mode. When the utility is restored, the UPS will auto restart in AC mode.

2. Turn on the UPS without utility power supply (in Battery mode)

- Make sure that the two strings of batteries are connected correctly at UPS's "+,GND,-" terminals and the breaker of the battery pack is at "ON" position (only for long-run model).



- Press the **POWER** button to set up the power supply for the UPS. UPS will enter to power on mode. After initialization, UPS will enter to No Output mode.
- A few seconds later, the UPS will be turned on and enter to Battery mode.

3. Connect devices to UPS

After the UPS is turned on, you can connect devices to the UPS.

- Turn on the UPS first and then switch on the devices one by one. The LCD panel will display total load level.
- If it is necessary to connect the inductive loads such as a printer, the in-rush current should be calculated carefully to see if it meets the capacity of the UPS, because the power consumption of this kind of loads is too big.
- If the UPS is overload, the buzzer will beep twice every second.
- When the UPS is overload, please remove some loads immediately. It is recommended to have the total loads connected to the UPS less than 80% of its nominal power capacity to prevent overload for system safety.
- If the overload time is over acceptable time listed in spec at AC mode, the UPS will automatically transfer to Bypass mode. After the overload is removed, it will return to AC mode. If the overload time is over acceptable time listed in spec at Battery mode, the UPS will become fault status. At this time, if bypass is enabled, the UPS will power to the load via bypass. If bypass function is disabled or the input power is not within bypass acceptable range, it will cut off output directly.

4. Charge the batteries

- After the UPS is connected to the utility power, the charger will charge the batteries automatically except in battery mode or during battery self-test or overload or battery high voltage.
- Suggest to charge batteries at least 10 hours before use. Otherwise, the backup time may be shorter than expected.

5. Battery mode operation

- When the UPS is in Battery mode, the buzzer will sound according to different battery capacity. If the battery capacity is more than 25%, the buzzer will beep once every 4 seconds. If the battery voltage drops to the alarm level, the buzzer will beep quickly (once every sec) to remind users that the battery is at low level and the UPS will shut down automatically soon. Users could switch off some non-critical loads to disable the shutdown alarm and prolong the backup time. If there is no more load to be switched off at that time, you have to shut down all loads as soon as possible to protect the devices or save data. Otherwise, there is a risk of data loss or load failure.

- In Battery mode, users can touch “SETTING” ► “Basic” ► Audio Mute to enable “Mode Mute” to disable the buzzer.
- The backup time of the long-run model depends on the external battery capacity.
- The backup time may vary from different environment temperature and load type.
- When setting backup time for 16.5 hours (default value from LCD menu), after discharging 16.5 hours, UPS will shut down automatically to protect the battery. This battery discharge protection can be enabled or disabled through LCD menu.

6. Test the batteries

- If you need to check the battery status when the UPS is running in AC mode/CVCF mode, you could touch “CONTROL” and select “Battery Test”. Refer to “Battery Test” screen.
- Users also can set battery self-test through monitoring software.

7. Turn off the UPS with utility power supply in AC mode

- Touch “CONTROL” and select “Turn off UPS” icon to turn off the UPS. Refer to “UPS on/off” screen.

NOTE!

If the UPS has been set to bypass output, it will bypass voltage from the utility power to output terminal even though you have turned off the UPS (inverter).

After turning off the UPS, please be aware that the UPS is working at Bypass mode and there is risk of power loss for connected devices.

- In Bypass mode, output voltage of the UPS is still present. In order to cut off the output, switch off the line input breaker(for dual input unit, also switch off the bypass line breaker). A few seconds later, there is no display shown on the display panel and UPS is complete off.

8. Turn off the UPS without utility power supply in Battery mode

- Touch “CONTROL” and select “Turn off UPS” icon to turn off the UPS. Refer to “UPS on/off” screen.
- Then UPS will cut off power to output terminals.

9. Mute the buzzer

- Touch “SETTING” and select “BASIC” item. There are two events available to mute. Refer to “SETTING” screen.



- Some warning alarms can't be muted unless the error is fixed. Please refer to section 3-3 for details.

10. Operation in warning status

- When Fault LED illuminates and the buzzer beeps once every second, it means that there are problems for UPS operation. Users can read the warning message(s) from "DATA LOG" menu. Please refer to the Section 3-2-6 for details.
- Some warning alarms can't be muted unless the error is fixed. Please refer to section 3-3 for details.

11. Operation in Fault mode

- When Fault LED illuminates and the buzzer beeps continuously, it means that there is a fatal error with the UPS. Users can get the fault code from "DATA LOG" menu. Please refer to the Section 3-2-6 for details.
- Please check the loads, wiring, ventilation, utility, battery and so on after the fault occurs. Don't try to turn on the UPS again before solving the issue. If the problems can't be fixed, please contact the distributor or service personnel immediately.
- For emergency case, please cut off connection from utility, external battery, and output immediately to avoid possible damage to the UPS or equipment.

12. Operation in maintaining bypass mode

This operation is only available for professional or qualified technicians. When the UPS needs to repair or service and then the load can't be shut off, the UPS needs to turn to maintenance mode.

- First, turn off the UPS.
- Second, remove the cover of maintenance bypass switch on the panel.
- Third, turn the maintenance switch to "BPS" position and turn off the UPS input breaker and output breaker.

3.5. Parallel operation

1. Parallel system initial startup

Please make sure that all of the running UPSs are parallel models and have the same configuration.

- Turn on each UPS in AC mode respectively (Refer to section 3-4(1)). Then, measure the inverter output voltage of each phase for each UPS with a multi-

meter. Calibrate the inverter output voltage by configuring inverter voltage adjustment (Refer to SETTING ► VOL CALI screen) in LCD menu until the inverter output voltage difference of each UPS is within 1V or less.

- Turn off each UPS (Refer to section 3-4(7.)). Then, follow the wiring procedure in section 2-4.
- Remove the cover of parallel share current cable port on the UPS, connect each UPS one by one with the parallel cable and share current cable, and then screw the cover back.
- Turn on the parallel system in AC mode:
 - a) Turn on the line input breaker of each UPS (for dual input, also turn on bypass input breaker). After all UPSs enter to bypass mode, measure the output voltage between two UPSs for the same phase to make sure the phase sequence is correct. If these two voltage differences are near to zero, that means all connections are met. Otherwise, please check if the wirings are connected correctly.
 - b) Turn on the output breaker of each UPS.
 - c) Turn on each UPS in turns. After a while, the UPSs will enter to AC mode synchronously and then, the parallel system is now complete.
- Turn on the parallel system in Battery mode:
 - a) Turn on the battery breaker (only available in long-run model) and output breaker of each UPS.
 - b) Turn on any UPS. A few seconds later, the UPS will enter to battery mode.
 - c) Turn on another UPS. A few seconds later, the UPSs enter to Battery mode and add to the parallel system.
 - d) If you have the third UPS, follow the same procedure of c). Then, the parallel system is complete.

NOTE!

If you would like to have more information regarding the parallel operation, please contact your supplier or service center for detail parallel operation instruction.

2. Add new units into the parallel system

- You can't add one new unit into the parallel system when whole system is running. You must cut off the load and shutdown the system.
- Make sure all of the UPS are the parallel models, and follow the wiring refer to section 2-4.
- Install the new parallel system refers to the previous section.



3. Remove units from the parallel system

There are two methods to remove units from the parallel system:

- First method:
 - a) Touch “CONTROL” ► “Turn off UPS” and select “Yes” to turn off the UPS. Then, the UPS will enter into Bypass mode or No Output mode without output.
 - b) Turn off the output breaker of this unit, and then turn off the input breaker of this unit.
 - c) After it shuts down, you can turn off the battery breaker (for long-run model) and remove the parallel and share current cables. And then remove the unit from the parallel system.
- Second method:
 - a) If the bypass is abnormal, you can not remove the UPS without interruption. You must cut off the load and shut down the system first.
 - b) Make sure the bypass setting is enabled in each UPS and then turn off the running system. All UPSs will transfer to Bypass mode. Remove all the maintenance bypass covers and set the maintenance switches from “UPS” to “BPS” position. Turn off all the input breakers and battery breakers in parallel system.
 - c) Turn off the output breaker and remove the parallel cable and share current cable of the UPS which you want to remove. Now, you can remove the UPS from parallel system.
 - d) Turn on the input breaker of the remaining UPS and the system will transfer to Bypass mode. Set the maintenance switches from “BPS” to “UPS” position and put the maintenance bypass covers back on.
 - d) Turn on the remaining UPS according to the previous section.

⚠ WARNING (Only for the parallel system)

- Before turning on the parallel system to activate inverter, make sure that all unit’s maintenance switch at the same position.
- When parallel system is turned on, please do not operate the maintenance switch of any unit.
- Please **DO NOT** enable the ECO mode in parallel system.

3.6. Fault Code

Fault code	Fault event
01	Bus start failure
02	Bus over
03	Bus under
04	Bus unbalance
06	Converter over current
11	Inverter soft start failure
12	High inverter voltage
15	Inverter B output(line to neutral) short circuited
16	Inverter C output(line to neutral) short circuited
17	Inverter A-B output (line to line) short circuited
18	Inverter B-C output (line to line) short circuited
19	Inverter C-A output (line to line) short circuited
1A	Inverter A negative power fault
1B	Inverter B negative power fault
1C	Inverter C negative power fault
21	Battery SCR short circuited
23	Inverter relay circuited open

Fault code	Fault event
43	Overload
46	Incorrect UPS setting
47	MCU communication failure
48	Two DSP firmware versions are incompatible in parallel system.
60	Bypass phase short circuited
61	Bypass SCR short circuited
62	Bypass SCR open circuited
63	Voltage waveform abnormal in A phase
64	Voltage waveform abnormal in B phase
65	Voltage waveform abnormal in C phase
66	Inverter current detect abnormal
67	Bypass O/P short circuited
68	Bypass O/P line to line short circuited
69	Inverter SCR short circuited
6C	BUS voltage drops too fast
6D	Current error value detect
6E	SPS power error

24	Inverter relay short circuited
25	Line wiring fault
31	Parallel communication failure
32	The host signal failure
33	Synchronous signal failure
34	Synchronous trigger signal failure
35	Parallel communication loss
36	Parallel output current unbalance
41	Over temperature
42	DSP communication failure

6F	Battery polarity reverse
71	PFC IGBT over-current in A phase
72	PFC IGBT over-current in B phase
73	PFC IGBT over-current in C phase
74	INV IGBT over-current in A phase
75	INV IGBT over-current in B phase
76	INV IGBT over-current in C phase
77	ISO Over temperature
78	LCD&MCU communication failed

3.7. Warning Code

Warning code	Warning event
01	Battery unconnected
02	IP Neutral loss
04	IP phase abnormal
05	Bypass phase abnormal
07	Over charge
08	Low battery
09	Overload
0A	Fan failure
0B	EPO enable
0D	Over temperature
0E	Charger failure

Warning code	Warning event
21	Line situations are different in parallel system
22	Bypass situations are different in parallel system
33	Locked in bypass after overload 3 times in 30 minutes
34	Converter current unbalanced
3A	Cover of maintain switch is open
3C	Utility extremely unbalanced
3D	Bypass is unstable
3E	Battery voltage too high
3F	Battery voltage unbalanced
40	Charger short circuited



4 Troubleshooting

If the UPS system does not operate correctly, please solve the problem by using the table below.

Problem	Possible cause	Solutions
No indication and alarm in the front display panel even though the mains is normal.	The AC input power is not connected well.	Check if input cable firmly connected to the mains.
The warning code 0B.	EPO function is activated. At this time, the EPO switch is in "OFF" status or the jumper is open.	Set the circuit in closed position to disable the EPO function.
The warning code 01.	The external or internal battery is incorrectly connected.	Check if all batteries are connected well.
The warning code 09.	UPS is overloaded.	Remove excess loads from UPS output.
	UPS is overloaded. Devices connected to the UPS are fed directly by the electrical network via the Bypass.	Remove excess loads from UPS output.
	After repetitive overloads, the UPS is locked in the Bypass mode. Connected devices are fed directly by the mains.	Remove excess loads from UPS output first. Then shut down the UPS and restart it.
Fault code is shown as 43.	UPS is overload too long and becomes fault. Then UPS shut down automatically.	Remove excess loads from UPS output and restart it.



Problem	Possible cause	Solutions
Fault code is shown as 14, 15, 16, 17, 18 or 19.	The UPS shut down automatically because short circuit occurs on the UPS output.	Check output wiring and if connected devices are in short circuit status.
Other fault codes are shown on LCD display and alarm beeps continuously.	A UPS internal fault has occurred.	Contact your dealer.
Battery backup time is shorter than nominal value.	Batteries are not fully charged.	Charge the batteries for at least 7 hours and then check capacity. If the problem still persists, consult your dealer.
	Batteries defect.	Contact your dealer to replace the battery.
The warning code 0A.	Fan is locked or not working. Or the UPS temperature is too high.	Check fans and notify dealer.
The warning code 02.	The input neutral wire is disconnected.	Check and correct the input neutral connection. If the connection is ok and the warning is still displaying, please refer to the LCD setting section, to enter the neutral loss check menu, to see if the parameter3 is "CHE". If it is, please press the "Enter" key firstly to make the "CHE" flash and press the "Enter" key secondly to make the UPS clear the alarm. If the warning still exists, please check input fuses of L2 and L3.
	The L2 or L3 input fuse is broken.	Replace the fuse.



5 Storage and maintenance

5.1. Storage

Before storing, charge the UPS at least 7 hours. Store the UPS covered and upright in a cool, dry location. During storage, recharge the battery in accordance with the following table:

Storage Temperature	Recharge Frequency	Charging Duration
-25°C - 40°C	Every 3 months	1-2 hours
40°C - 45°C	Every 1 months	

5.2. Maintenance

- The UPS system operates with hazardous voltages. Repairs may be carried out only by qualified maintenance personnel.
- Even after the unit is disconnected from the mains, components inside the UPS system are still connected to the battery packs which are potentially dangerous.
- Before carrying out any kind of service and/or maintenance, disconnect the batteries and verify that no current is present and no hazardous voltage exists in the terminals of high capability capacitor such as BUS-capacitors.
- Only persons are adequately familiar with batteries and with the required precautionary measures may replace batteries and supervise operations. Unauthorized persons must be kept well away from the batteries.
- Verify that no voltage between the battery terminals and the ground is present before maintenance or repair. In this product, the battery circuit is not isolated from the input voltage. Hazardous voltages may occur between the battery terminals and the grounding/earthing.
- Batteries may cause electric shock and have a high short-circuit current. Please remove all wristwatches, rings and other metal person objects before maintenance or repair, and only use tools with insulated grips and handles for maintaining or repairing.
- When replacing the batteries, install the same number and same type of batteries.

- Do not attempt to dispose of batteries by burning them. This could cause battery explosion. The batteries must be deposited according to local environmental regulations.
- Do not open or destroy batteries. Escaping electrolyte can cause injury to the skin and eyes. It may be toxic.
- Please replace the fuse only with the same type and amperage in order to avoid fire hazards.
- Do not disassemble the UPS system.



EU Declaration of Conformity

We, manufacturer / importer

DAI-TECH SRL
28 Popa Șapcă
300057, Timișoara
Romania

declare that the products

UPS Garun Series:
UP33TOP110KGAAZ01B, UP33TOP115KGAAZ01B, UP33TOP120KGAAZ01B,
UP33TOP130KGAAZ01B, UP33TOP140KGAAZ01B,
UP33TOP160KGAAZ01B, UP33TOP180KGAAZ01B

are in conformity with

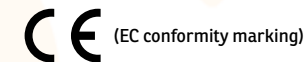

Tested with the listed standards, the above mentioned products were found in compliance with **LVD 2014/35/EU Directive** and with **2014/30/EMC Directive**.

EN62040-1:2008+A1:2013	EN61000-4-2:2009	EN61000-4-6:2014
EN62040-2:2006+AC:2006	EN61000-4-3:2006+A2:2010	EN61000-4-8:2010
EN 61000-3-2:2014	EN61000-4-4:2012	EN61000-2-2:2012
	EN61000-4-5:2016	

and in conformity with



(RoHS conformity marking) in accordance with European Directive 2011/65/EU; (EU)2015/863.

EN50581:2012

EN62321:2009



Stamp

July 27, 2019
Timișoara

Date and location

Tommy Lee

Signature and name



Disposal of Old Electrical & Electronic Equipment

(Applicable in the European Union and other European countries with separate collection systems)

This symbol on the product or on its packaging indicates that this product shall not be treated as household waste.

Instead it shall be handed over to the applicable collection point for the recycling of electrical and electronic equipment.

By ensuring this product is disposed of correctly, you will help prevent potential negative consequences for the environment and human health, which could otherwise be caused by inappropriate waste handling of this product.

The recycling of materials will help to conserve natural resources.





Memo

A series of horizontal dotted lines for writing, filling the main body of the page.



Memo

A series of horizontal dotted lines for writing, filling the main body of the page.

