

 **MC70** (v1.0)

USER/INSTALLER MANUAL

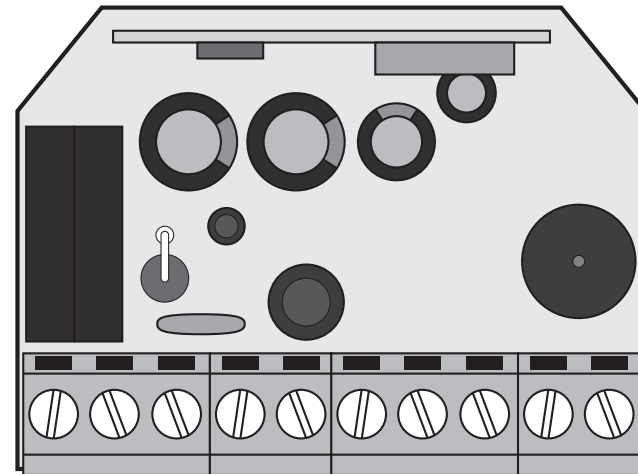

00. CONTENT

INDEX

01. SAFETY INSTRUCTIONS	
STANDARDS TO FOLLOW	2B
02. CONNECTIONS SCHEME	
CONNECTION TO A WALL SWITCH WITH 2 KEYS	3A
CONNECTION TO A WALL SWITCH WITH 1 KEY	3B
SEVERAL MC70 CONTROL BOARD CONNECTIONS - MASTER FUNCTION	4
03. THE CONTROL BOARD	
TECHNICAL CHARACTERISTICS	5A
04. PROGRAMMING	
PRE-PROGRAMMING INFORMATION	5B
PROGRAMMING	6B
CONTROL BOARD'S RESET	8B

01. SAFETY INSTRUCTIONS

ATTENTION:

	This product is certified in accordance with European Community (EC) safety standards.
	This product complies with Directive 2011/65 / EU of the European Parliament and of the Council, of 8 June 2011, on the restriction of the use of certain hazardous substances in electrical and electronic equipment.
	(Applicable in countries with recycling systems). This marking on the product or literature indicates that the product and electronic accessories (eg. Charger, USB cable, electronic material, controls, etc.) should not be disposed of as other household waste at the end of its useful life. To avoid possible harm to the environment or human health resulting from the uncontrolled disposal of waste, separate these items from other types of waste and recycle them responsibly to promote the sustainable reuse of material resources. Home users should contact the dealer where they purchased this product or the Environment Agency for details on where and how they can take these items for environmentally safe recycling. Business users should contact their vendor and check the terms and conditions of the purchase agreement. This product and its electronic accessories should not be mixed with other commercial waste.
	
	This marking indicates that the product and electronic accessories (eg. charger, USB cable, electronic material, controls, etc.) are susceptible to electric shock by direct or indirect contact with electricity. Be cautious when handling the product and observe all safety procedures in this manual.

- It is important for your safety that these instructions are followed.
- Keep these instructions in a safe place for future reference.
- The **ELECTROCELOS S.A.** is not responsible for the improper use of the product, or other use than that for which it was designed.
- The **ELECTROCELOS S.A.** is not responsible if safety standards were not taken into account when installing the equipment, or for any deformation that may occur.
- The **ELECTROCELOS S.A.** is not responsible for insecurity and malfunction of the product when used with components that were not sold by the them.
- This product was designed and manufactured strictly for the use indicated in this manual.
- This control board is not appropriate for inflammable or explosive environments.
- Any other use not expressly indicated may damage the product and/or can cause physical and property damages, and will void the warranty.
- Do not make any changes to the automation components and/or their accessories.
- Control board for indoor use with 110V/230V connection.
- Keep remote controls away from children, to prevent the automated system from being activated involuntarily.
- The customer shall not, under any circumstances, attempt to repair or tune the automatism. Must call qualified technician only.
- The installer must have certified professional knowledge at the level of mechanical assemblies in doors and gates and control board programming. He should also be able to perform electrical connections in compliance with all applicable regulations.
- The installer should inform the customer how to handle the product in an emergency and provide him the manual.

02. CONNECTIONS SCHEME

CONNECTION TO A WALL SWITCH WITH 2 KEYS

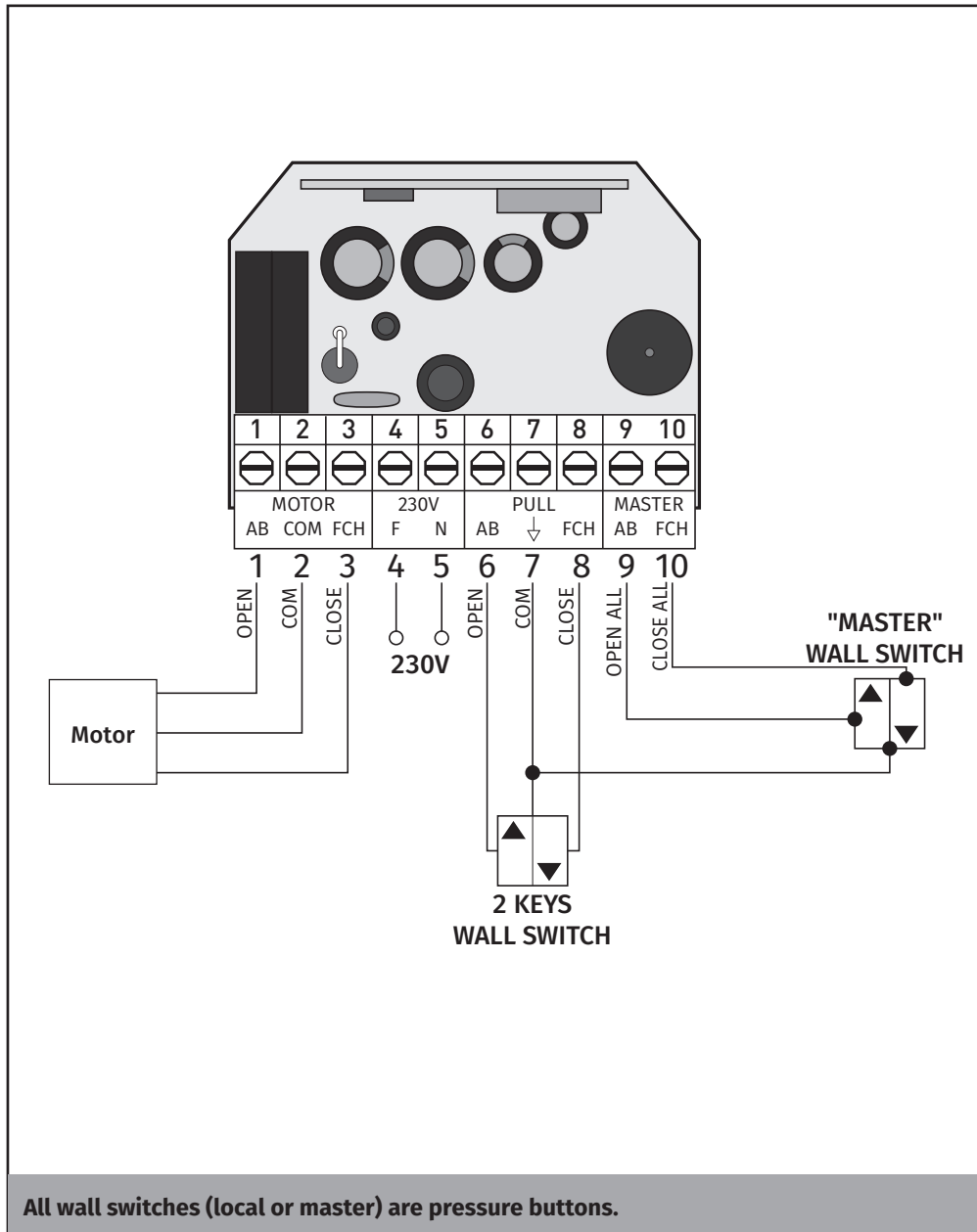

2A
EN

CONNECTION TO A WALL SWITCH WITH 1 KEY

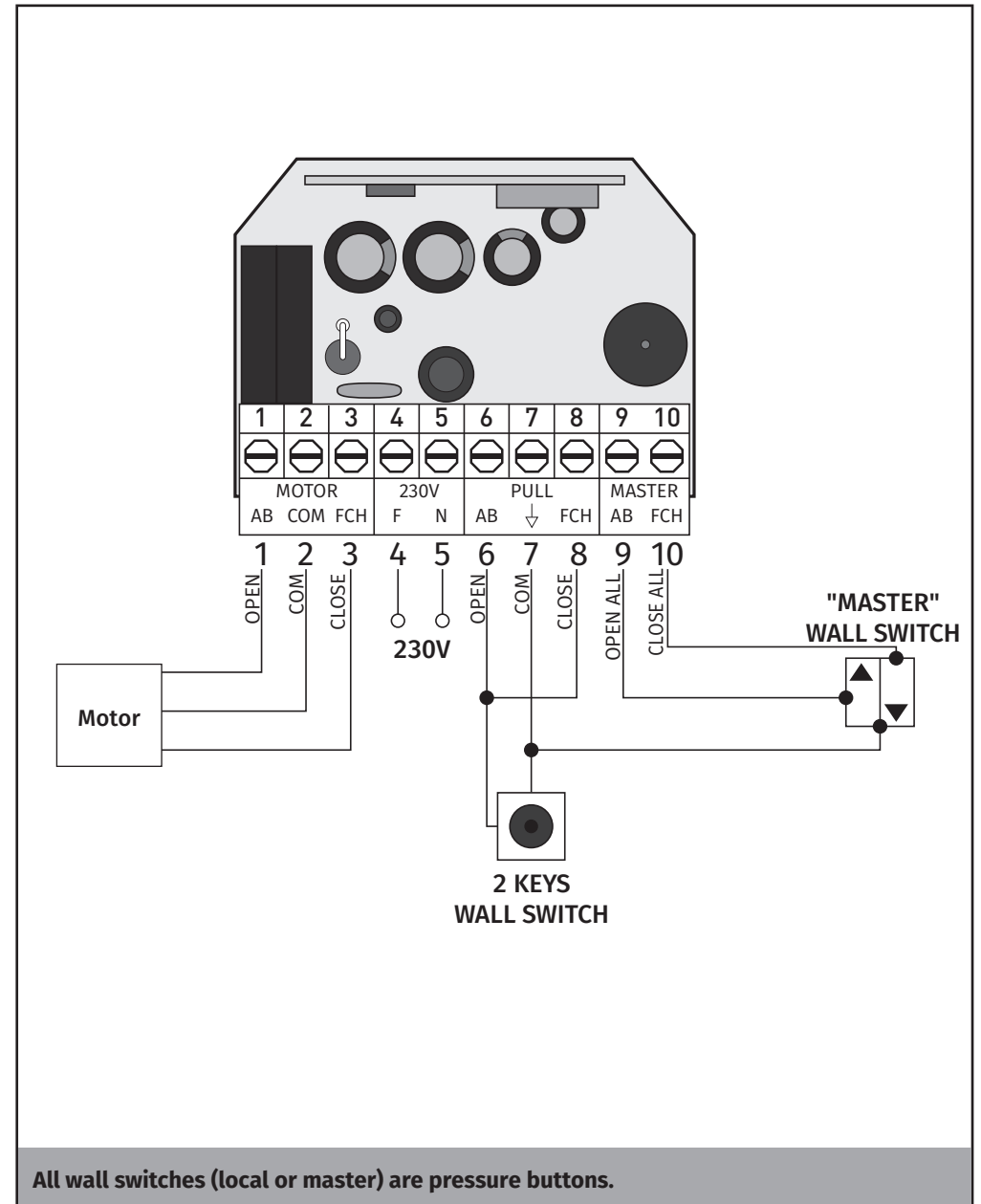

2B
EN

02. CONNECTIONS SCHEME

SEVERAL MC70 CONTROL BOARD CONNECTIONS - MASTER FUNCTION

The MC70 control board MASTER function allows to connect and control several MC70 control boards in the same wall switch (MASTER switch). In this way, whenever a Master switch button is pressed, all the interconnected control boards send a impulse to the motors to start the maneuver at the same time.

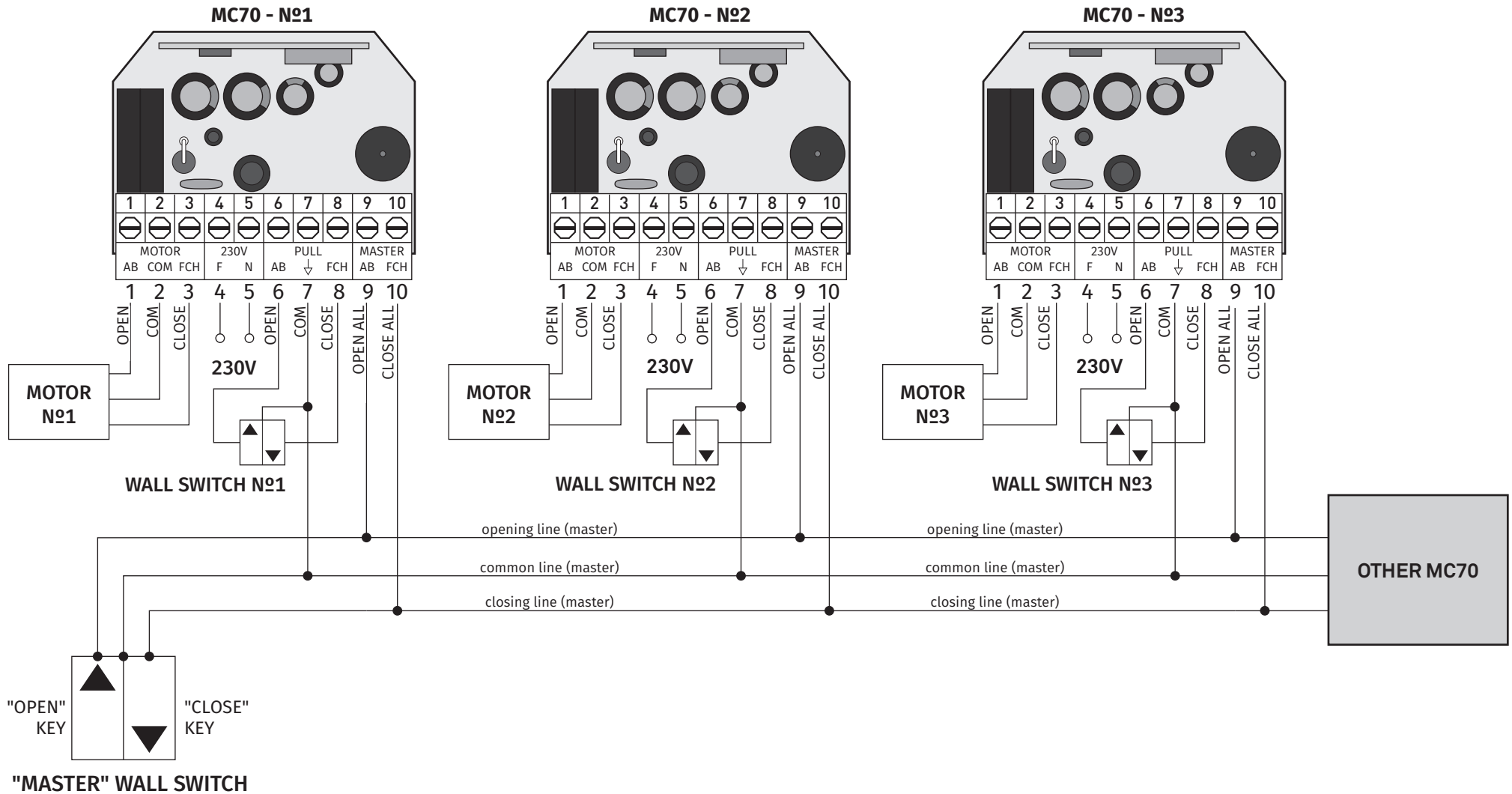

03. THE CONTROL BOARD

TECHNICAL CHARACTERISTICS

This control board was developed to control TUB/ Rolling motors. Its small size allows it to be installed in junction boxes, existing behind electrical switches (push buttons). It has 2 inputs for pushbuttons with 1 or 2 keys, one for local control and another for centralized control, linking several MC70 control boards on the same wall switch (Master switch).

The control board allows to be controlled with commands through 1 or 3 keys. All programming is done at a distance, being only necessary access to a power supply or a wall switch to program the first transmitter.

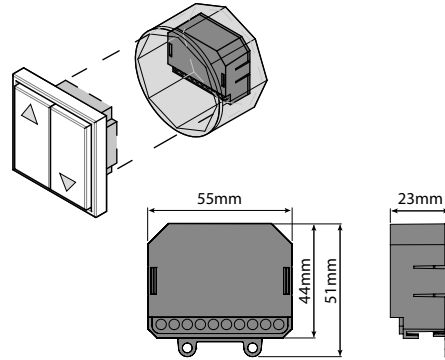

• CHARACTERISTICS BOARD

• Power Supply	230V AC 50-60Hz
• Motor's output	AC230V; 750W Máx
• Radio Receiver incorporated	433,92 MHz
• Working temperature	-20°C to 70°C
• Nº of channels	15
• Code type	Rolling Code
• Protection grade	IP44
• Fixed maximum working time per maneuver	2min
• Dimension of box with control board	56x44x23mm
• Box material	ABS

• CONNECTOR'S DESCRIPTION

CN1	01 • Motor output -Opening
	02 • Motor output - Common
	03 • Motor output - Closing
	04 • 230V power supply (phase)
	05 • 230V power supply (neutral)
	06 • Wall switch connection - OPENING (NA)
	07 • Wall switch connection - COMMON
	08 • Wall switch connection - CLOSING (NA)
	09 • Wall switch connection - MASTER - OPENING (NA)
	10 • Wall switch connection - MASTER - CLOSING (NA)
Attention: The MASTER switch connects the common wire in the 07 connector	

04. PROGRAMMING

PRE-PROGRAMMING INFORMATION

• TRANSMITTER PROGRAMMING TYPE

The control board allows the programming of two operating modes in transmitters: 1 key or 3 keys.

OPERATING MODE	PERFORMANCE
1 KEY	You can program any key on the remote, that key will send all orders to the exchange. Example: Open - Stop - Close - Stop -Open (...)
3 KEYS	The programmed transmitter will work with the buttons: OPEN CLOSE STOP . Each button will send a different order to the board.

To know the keys **OPEN**, **STOP** and **CLOSE** of the various transmitters, check the following schemes:

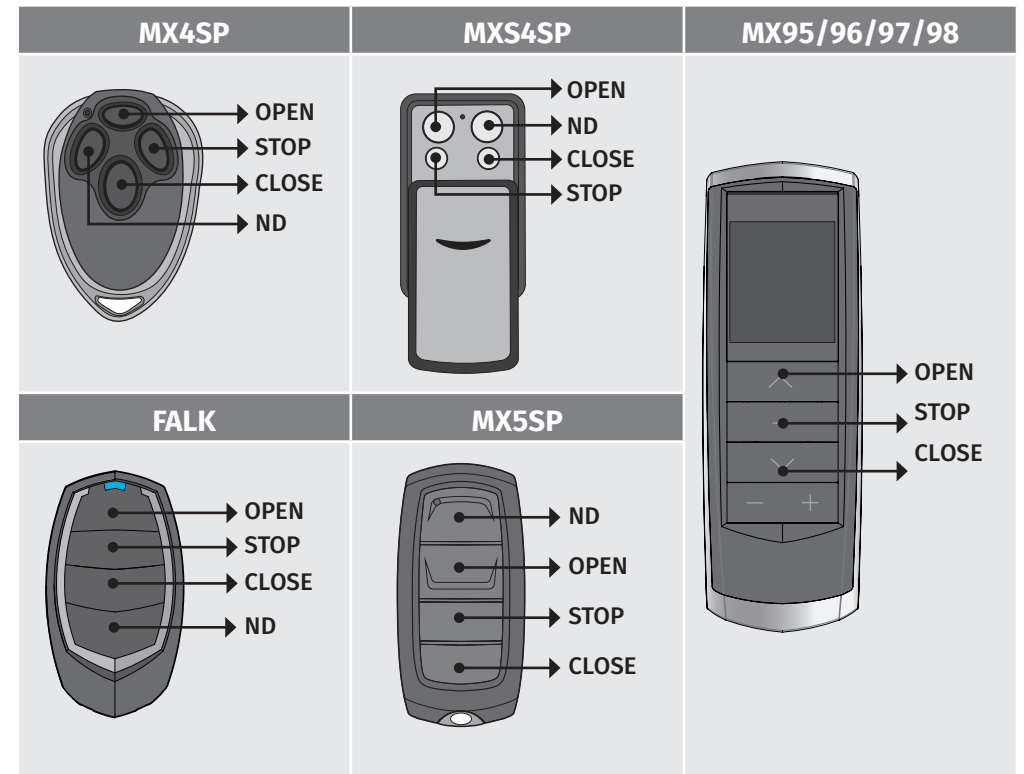

04. PROGRAMMING

PRE-PROGRAMMING INFORMATION

• WALL SWITCHES

The center allows the connection of pressure switches with one or two keys. To start a maneuver, just do a simple 1 second pulse at the desired key.

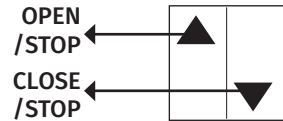

2 KEYS SWITCH

It has two buttons, one for opening and one for closing. During opening or closing maneuver, a click on the contrary key to the motor movement will stop this maneuver.

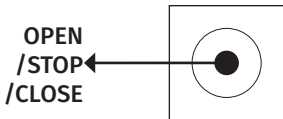

1 KEY SWITCH

It has only one button for opening and closing. Clicking on the button for opening/closing will stop the motor movement.

PROGRAMMING

• TRANSMITTER PROGRAMMING

This control board only allows programming MOTORLINE rolling code transmitters by a maximum of 15 transmitters. When programming the 16th transmitter, the control board emits 4 beeps to signal that the memory is full.

It is possible to program the first transmitter through the control board power supply or via a push button. When you have an already programmed transmitter, you can use it to open the memory of the control board at distance and program new commands.

Programming new transmitter (3 keys):

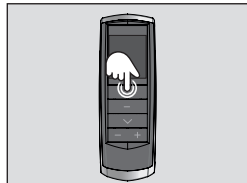

01 • Continuously press the **OPEN** key of the transmitter you want to program.

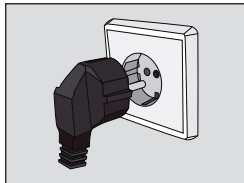

02 • Connect the control board to a 230 power supply.

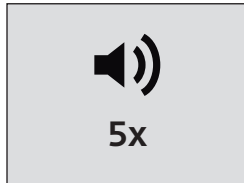

03 • Hold the **OPEN** key for 10 sec, during which the control board emits 5 slowly beeps.

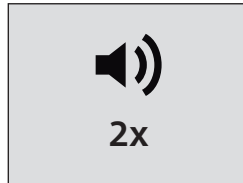

04 • After 10 sec, the control unit emits 2 quick beeps confirming the program success.

04. PROGRAMMING

PROGRAMMING

Programming new transmitter (1 key):

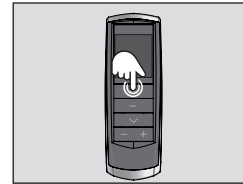

01 • Continuously press the **OPEN** key of the transmitter you want to program.

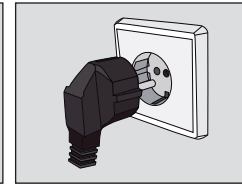

02 • Connect the control board to a 230 power supply.



03 • Hold the **OPEN** key for 10 sec, during which the control board emits 5 slowly beeps.



04 • After 10 sec, the control unit emits 2 quick beeps. Do not release the transmitter key!

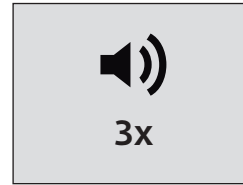

05 • Hold the **OPEN** key for 10 sec, during which the control board emits 3 slowly beeps.

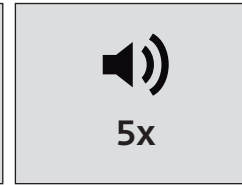

06 • After the total 20 sec (10 + 10), the central emits 5 quick beeps confirming the program success.

Programming new (3 keys) transmitter through another already programmed (3

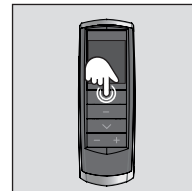

01 • Continuously press the **OPEN** key of an already programmed transmitter, for 15sec.

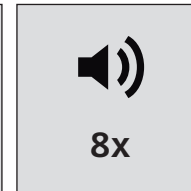

02 • After 15 sec, the control board emits 8 quick beeps. Release the key of the already programmed transmitter.

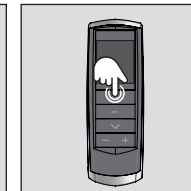

03 • Continuously press the **OPEN** key of the transmitter you want to program.

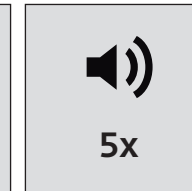

04 • Hold the **OPEN** key for 10 sec, during which the control board emits 5 slowly beeps.

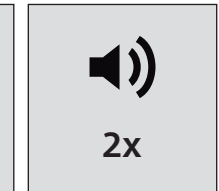

05 • After 10 sec, the control unit emits 2 quick beeps confirming the program success.

04. PROGRAMMING

PROGRAMMING

Programming new (1 key) transmitter through another already programmed (1 key):

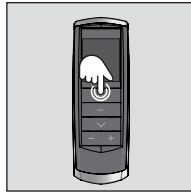

8x

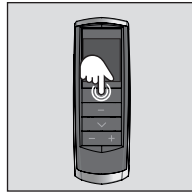

5x

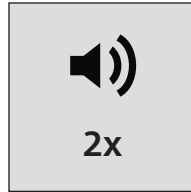

2x

01 • Continuously press the **OPEN** key of an already programmed transmitter, for 15sec.

02 • After 15 sec, the control board emits 8 quick beeps. Release the key of the already programmed transmitter.

03 • Continuously press the **OPEN** key of the transmitter you want to program.

04 • Hold the **OPEN** key for 10 sec, during which the control board emits 5 slowly beeps.

05 • After 10 sec, the control unit emits 2 quick beeps. Do not release the transmitter key!



3x



5x

06 • Hold the **OPEN** key for more 10 sec, during which the control board emits 3 slowly beeps.

07 • After the total 20 sec (10 + 10), the central emits 5 quick beeps confirming the program success.

Programming new transmitter (3keys) through a 2 buttons wall switch:

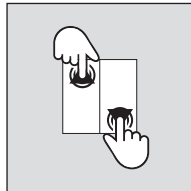

8x

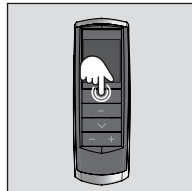

5x



2x

01 • Continuously press the **OPEN** and **CLOSE** keys of a wall switch, for 15sec.

02 • After 15 sec, the control board emits 8 quick beeps. Release wall switch keys.

03 • Continuously press the **OPEN** key of the transmitter you want to program.

04 • Hold the **OPEN** key for 10 sec, during which the control board emits 5 slowly beeps.

05 • After 10 sec, the control unit emits 2 quick beeps confirming the program success.

04. PROGRAMMING

PROGRAMMING

Programming new transmitter (1key) through a 2 buttons wall switch:

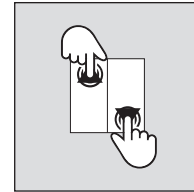

8x

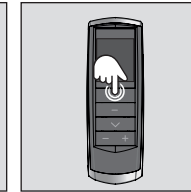

5x

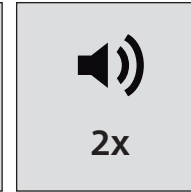

2x

01 • Continuously press the **OPEN** and **CLOSE** keys of a wall switch, for 15sec.

02 • After 15 sec, the control board emits 8 quick beeps. Release wall switch keys.

03 • Continuously press the **OPEN** key of the transmitter you want to program.

04 • Hold the **OPEN** key for 10 sec, during which the control board emits 5 slowly beeps.

05 • After 10 sec, the control unit emits 2 quick beeps. Do not release the transmitter key!



3x

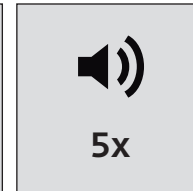

5x

06 • Hold the **OPEN** key for more 10 sec, during which the control board emits 3 slowly beeps.

07 • After the total 20 sec (10 + 10), the central emits 5 quick beeps confirming the program success.

Programming new transmitter (3keys) through a 1 button wall switch:

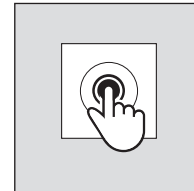

8x

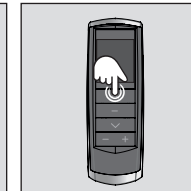

5x

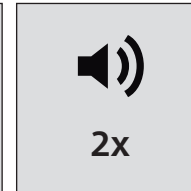

2x

01 • Continuously press the wall switch button, for 15sec.

02 • After 15 sec, the control board emits 8 quick beeps. Release wall switch key.

03 • Continuously press the **OPEN** key of the transmitter you want to program.

04 • Hold the **OPEN** key for 10 sec, during which the control board emits 5 slowly beeps.

05 • After 10 sec, the control unit emits 2 quick beeps confirming the program success.

04. PROGRAMMING

PROGRAMMING

Programming new transmitter (1key) through a 1 button wall switch:

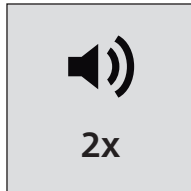
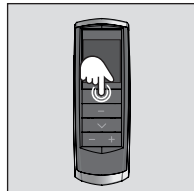
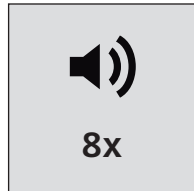
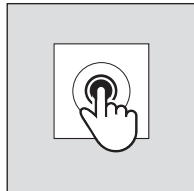

01 • Continuously press the wall switch button, for 15sec.

02 • After 15 sec, the control board emits 8 quick beeps. Release wall switch key.

03 • Continuously press the **OPEN** key of the transmitter you want to program.

04 • Hold the **OPEN** key for 10 sec, during which the control board emits 5 slowly beeps.

05 • After 10 sec, the control unit emits 2 quick beeps. Do not release the transmitter key!



06 • Hold the **OPEN** key for more 10 sec, during which the control board emits 3 slowly beeps.

07 • After the total 20 sec (10 + 10), the central emits 5 quick beeps confirming the program success.

Change motor's direction:

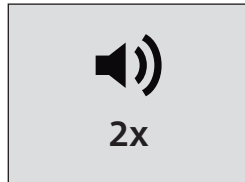
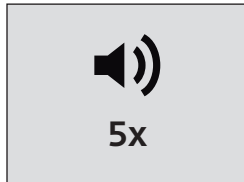
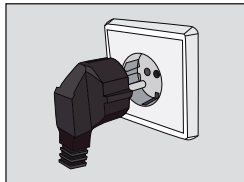
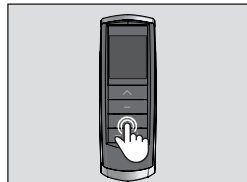

01 • Continuously press the **CLOSE** key of an already programmed transmitter.

02 • Connect the control board to a 230 power supply.

03 • Hold the **CLOSE** key for 10 sec, during which the control board emits 5 slowly beeps.

04 • After 10 sec, the control unit emits 2 quick beeps confirming the program success.

04. PROGRAMMING

PROGRAMMING

Delete all transmitters through an already programmed transmitter:

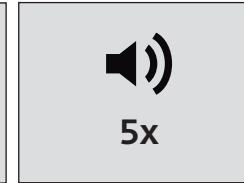
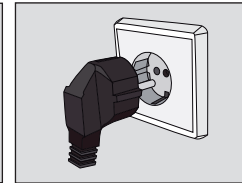
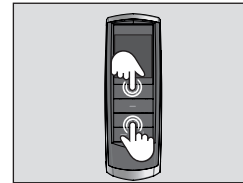

01 • Continuously press the **OPEN** and **CLOSE** keys of an already programmed transmitter.

02 • Connect the control board to a 230 power supply.

03 • Hold the **OPEN** and **CLOSE** keys for 10 sec, during which the control board emits 5 slowly beeps.

04 • After 10 sec, the control unit emits 2 quick beeps confirming the program success.

Delete all transmitters through a 2 buttons wall switch:

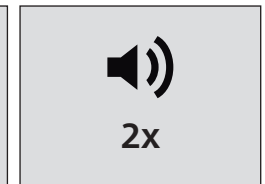
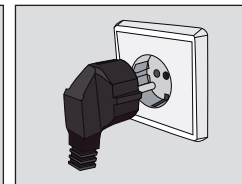
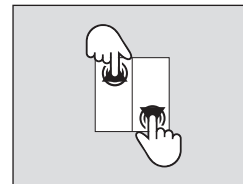

01 • Continuously press the **OPEN** and **CLOSE** keys of a wall switch.

02 • Connect the control board to a 230 power supply.

03 • Hold the **OPEN** and **CLOSE** keys for 10 sec, during which the control board emits 5 slowly beeps.

04 • After 10 sec, the control unit emits 2 quick beeps confirming the program success.

Delete all transmitters through a 1 button wall switch:

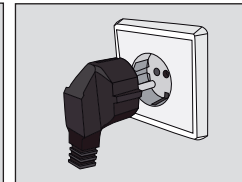

01 • Continuously press the wall switch button.

02 • Connect the control board to a 230 power supply.

03 • Hold the **button** for 10 sec, during which the control board emits 5 slowly beeps.

04 • After 10 sec, the control unit emits 2 quick beeps confirming the program success.