

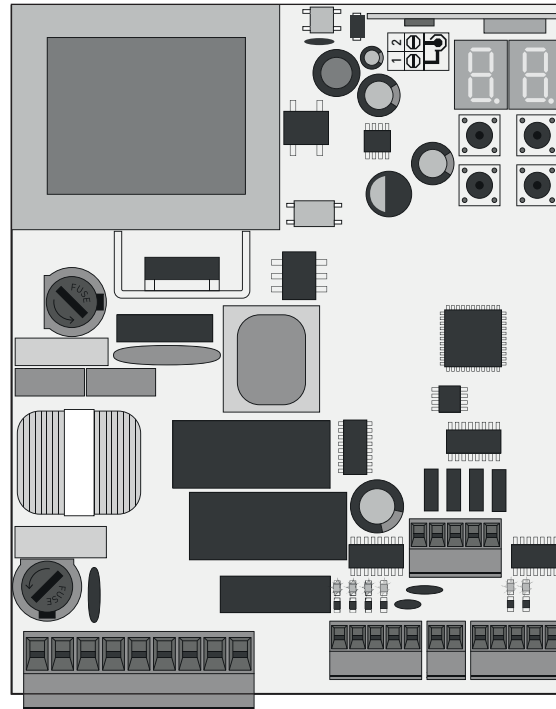

MC50

USER/INSTALLER MANUAL



00. CONTENT

INDEX

01. SAFETY INSTRUCTIONS

STANDARDS TO FOLLOW	2A
---------------------	----

02. CONTROL BOARD

TECHNICAL SPECIFICATIONS	4B
PROGRAMMING PRE-RECOMENDATIONS	5A

03. CONTROL BOARD

INSTALLATION OF MCONNECT LINK (OPTIONAL)	5B
ESSENTIAL STEPS FOR INSTALLATION	6A
REMOTE CONTROLS	6B
"P" MENU FUNCTIONS	7A
"E" MENU FUNCTIONS	7B

04. PROGRAMMING (P)

P0-AUTOMATIC AND SEMI-AUTOMATIC COURSE PROGRAMMING	8A
P1-RAMP ADJUSTMENT	8B
P2-FORCE AND SENSITIVITY ADJUSTMENT	8B
P3-PEDESTRIAN TIME	9A
P4-PAUSE TIME	9B
P5-PHOTOCELLS PROGRAMMING	9B
P6-SAFETY EDGE	10A
P7-OPERATING LOGIC	10B
P8-FLASHING LIGHT	10B
P9-REMOTE PROGRAMMING	11A

05. PROGRAMMING (E)

E0-HUMAN PRESENCE	11B
E1-SOFT START AND SOFT STOP	11B
E2-COURTESY LIGHT TIME/PRE-FLASHING LIGHT	12A
E3-FOLLOW ME	12A
E5-ELECTRIC BRAKE	12B
E6-DECELERATION SPEED	12B
E7-MANEUVERS COUNTER	12B
E8-RESET - RESTORE FACTORY VALUES	13A
E9-RGB OUTPUT	13A

06. DISPLAY

DISPLAY INDICATIONS	13B
---------------------	-----

07. COMPONENTS TEST

CAPACITOR SCHEME	14
------------------	----

08. CONNECTION SCHEME

CONNECTIONS SCHEME - SLIDING GATES	15
CONNECTIONS SCHEME - SECTIONAL DOORS	16
CONNECTIONS SCHEME - BARRIERS	17
CONNECTIONS SCHEME - PHOTOCELLS TEST ACTIVE	18

09. TROUBLESHOOTING

INSTRUCTIONS FOR FINAL CONSUMERS/TECHNICIANS	19
--	----

01. SAFETY INSTRUCTIONS

	Dit product is gecertificeerd in overeenstemming met de veiligheidsnormen van de Europese Commissie ("EC").
RoHS	Dit product voldoet aan Richtlijn 2011/65/EU van het Europees Parlement en de Raad, van 8 juni 2011, betreffende beperking van het gebruik van bepaalde gevaarlijke stoffen in elektrische en elektronische apparatuur en aan Gedelegeerde Richtlijn (EU) 2015/863 van de Commissie.
	(Van toepassing in landen met een recyclingsysteem). Deze markering op het product of in de literatuur geeft aan dat het product en de elektronische accessoires (bijv. oplader, USB-kabel, elektronisch materiaal, bedieningselementen, enz.) aan het einde van de levensduur niet als ander huishoudelijk afval mogen worden afgevoerd. Om mogelijke schade aan het milieu of de volksgezondheid als gevolg van het ongecontroleerd weggooien van afval te voorkomen, dient u deze items van andere soorten afval te scheiden en op verantwoorde wijze te recyclen, ter bevordering van het duurzame hergebruik van materiële hulpbronnen. De consument dient contact op te nemen met de leverancier waar hij dit product heeft gekocht of met de nationale milieu-instantie voor informatie over waar en hoe hij deze artikelen kan inleveren voor milieuveilige recycling. Zakelijke gebruikers dienen contact op te nemen met hun leverancier en de voorwaarden van de koopovereenkomst te controleren. Dit product en zijn elektronische accessoires mogen niet worden gemengd met ander bedrijfsafval.
	Deze markering geeft aan dat batterijen aan het einde van hun levensduur niet mogen worden weggegooid zoals ander huishoudelijk afval. Batterijen moeten worden ingeleverd bij selectieve inzamelpunten voor recycling.
	De verschillende soorten verpakking (karton, plastic, enz.) moeten selectief worden ingezameld voor recycling. Scheid de verpakking en recycle deze op verantwoorde wijze.
	Deze markering geeft aan dat het product en de elektronische accessoires (bijv. lader, USB-kabel, elektronisch materiaal, bedieningselementen, enz.) gevoelig zijn voor elektrische schokken door direct of indirect contact met elektriciteit. Wees voorzichtig bij het hanteren van het product en neem alle veiligheidsprocedures in deze handleiding in acht.

WAARSCHUWINGEN ALGEMEEN

- Deze handleiding bevat zeer belangrijke veiligheids- en gebruiksinformatie. ZEER BELANGRIJK. Lees alle instructies zorgvuldig door voor u met de installatie/gebruik procedures begint en bewaar deze handleiding op een veilige plaats zodat u ze kan raadplegen wanneer dat nodig is.
- Dit product is uitsluitend bestemd voor gebruik zoals beschreven in deze handleiding. Elke andere uitvoering of bediening die niet vermeld is, is uitdrukkelijk verboden, omdat deze het product kan beschadigen en mensen in gevaar kan brengen met ernstig letsel tot gevolg.
- Deze handleiding is in de eerste plaats bedoeld voor gespecialiseerde monteurs, en ontslaat de gebruiker niet van zijn verantwoordelijkheid om het hoofdstuk "Gebruikersvoorschriften" te lezen om een correcte werking van het product te verzekeren.
- De installatie en reparatie van dit product mag alleen worden uitgevoerd door gekwalificeerde en gespecialiseerde monteurs, om er zeker van te zijn dat elke procedure wordt uitgevoerd in overeenstemming met de geldende regels en normen. Het is niet toegestaan handelingen te verrichten door niet-professionele en onervaren gebruikers, tenzij hiertoe uitdrukkelijk verzocht wordt door gespecialiseerde monteurs.
- De installatie moet regelmatig gecontroleerd worden op onbalans en slijtagesignalen van de kabels, veren, scharnieren, wielen, steunen en andere mechanische montagedelen.
- Gebruik het product niet als reparatie of afstelling noodzakelijk is.
- Bij onderhoud, reiniging en vervanging van onderdelen moet het product worden losgekoppeld van de stroomvoorziening. Dit geldt ook voor alle handelingen waarbij het deksel van het product geopend moet worden.
- Het gebruik, de reiniging en het onderhoud van dit product mogen worden uitgevoerd door personen van acht jaar en ouder en personen met een lagere fysieke, sensorische of mentale capaciteit, of door personen zonder enige kennis van het product, op voorwaarde dat deze onder toezicht staan en instructies krijgen van personen met ervaring in het gebruik van het product op een veilige manier en die de risico's en gevaren begrijpen die ermee gepaard gaan.
- Kinderen mogen niet met het product of de openingsinrichtingen spelen om te voorkomen dat de gemotoriseerde deur of poort onvrijwillig in werking wordt gesteld.

01. SAFETY INSTRUCTIONS

- Als de voedingskabel beschadigd is, moet deze worden vervangen door de fabrikant, de after-sales service of vergelijkbaar gekwalificeerd personeel om gevaar te voorkomen.
- Bij het verwijderen van de batterij moet het apparaat worden losgekoppeld van de voeding.
- Zorg ervoor dat er geen blokkering optreedt tussen het bediende deel en de vaste onderdelen als gevolg van de openingsbeweging van het bediende deel.

WAARSCHUWINGEN VOOR MONTEURS

- Alvorens met de installatieprocedures te beginnen, dient u zich ervan te verzekeren dat u over alle apparatuur en materialen beschikt die nodig zijn om de installatie van het product te voltooien.
- Noteer de beschermingsindex (IP) en de bedrijfstemperatuur om er zeker van te zijn dat deze geschikt is voor de installatieplaats.
- Geef de handleiding van het product aan de gebruiker en laat hem weten hoe hij in geval van nood met het product moet omgaan.
- Indien het apparaat wordt geïnstalleerd op een poort met een loopdeur, dan moet een deurvergrendelingsmechanisme worden geïnstalleerd wanneer de poort in beweging is.
- Installeer het product niet "ondersteboven" of ondersteund door elementen die het gewicht niet dragen. Indien nodig moet u op strategische punten beugels aanbrengen om de veiligheid van het apparaat te garanderen.
- Installeer het product niet op een explosiegevaarlijke plaats.
- De veiligheidsvoorzieningen moeten de mogelijke knel-, snij-, transport- en gevarenczones van de gemotoriseerde deur of poort beschermen.
- Controleer of de te automatiseren elementen (poorten, deur, ramen, zonwering, enz.) perfect functioneren, uitgelijnd en waterpas zijn. Controleer ook of de nodige mechanische stoppers zich op de juiste plaatsen bevinden.
- De centrale moet worden geïnstalleerd op een veilige plaats waar geen vocht (regen, condens, enz.), stof of ongedierte kan binnendringen.
- U moet de verschillende elektrische kabels door beschermende

- buizen leiden, om ze te beschermen tegen mechanische invloeden, in het bijzonder de voedingskabel. Let erop dat alle kabels van onderaf de centrale moeten binnenkomen.
- Indien het apparaat op een hoogte van meer dan 2,5m van de grond of een ander toegangsniveau moet worden geïnstalleerd, moeten de minimale veiligheids- en gezondheidsvoorschriften voor het gebruik van arbeidsmiddelen op het werk van de richtlijn 2009/104/CE van het Europees Parlement en de Raad van 16 september 2009 worden nageleefd.
- Bevestig het permanente etiket voor de handmatige ontgrendeling zo dicht mogelijk bij het ontgrendelingsmechanisme.
- De vaste voedingskabels van het product moeten volgens de installatievoorschriften van stroomonderbrekers zijn voorzien, zoals een schakelaar of een stroomonderbreker op het elektrische paneel.
- Als voor het te installeren product een stroomvoorziening van 230Vac of 110Vac nodig is, zorg er dan voor dat de aansluiting plaatsvindt op een elektrisch paneel met aardaansluiting.
- Het product wordt alleen gevoed door laagspanning safety met centrale (alleen bij 24V motoren).
- Onderdelen/producten die meer dan 20 kg wegen, moeten met speciale zorg worden behandeld vanwege het risico op letsel. Het wordt aanbevolen om geschikte hulpsystemen te gebruiken voor het verplaatsen of optillen van zware voorwerpen.
- Besteed extra aandacht aan het gevaar van vallende voorwerpen of ongecontroleerde beweging van deuren/poorten tijdens de installatie of bediening van dit product.

WAARSCHUWINGEN VOOR GEBRUIKERS

- Bewaar deze handleiding op een veilige plaats om ze te kunnen raadplegen wanneer dat nodig is.
- Indien het product in contact komt met vloeistoffen zonder dat het is voorbereid, moet het onmiddellijk van het stroomnet worden losgekoppeld om kortsluiting te voorkomen, en moet een gespecialiseerde technicus worden geraadpleegd.
- Zorg ervoor dat de technicus u de handleiding van het product heeft overhandigd en u heeft geïnformeerd over hoe u in geval van nood met het product moet omgaan.

01. SAFETY INSTRUCTIONS

- Indien het systeem moet worden gerepareerd of aangepast, ontgrendel dan het apparaat, schakel de stroom uit en gebruik het niet totdat aan alle veiligheidsvoorwaarden is voldaan.
- In geval van een doorgeslagen zekeringsautomaat of een defecte stop, dient u de sturing op te sporen en te verhelpen voordat u de automaat terugzet of de zekering vervangt. Als de sturing niet kan worden verholpen door deze handleiding te raadplegen, neem dan contact op met een monteur.
- Houd het bedieningsgebied van de gemotoriseerde poort vrij terwijl de poort in beweging is, en creëer geen spanning op de beweging van de poort.
- Voer geen handelingen uit aan mechanische elementen of scharnieren als het product in beweging is.

AANSPRAKELIJKHEID

- Leverancier wijst elke aansprakelijkheid af indien:
 - Product storing of vervorming het gevolg zijn van onjuiste installatie gebruik of onderhoud!
 - Veiligheidsnormen niet worden nageleefd bij de installatie, gebruik en/of het onderhoud van het product.
 - Instructies in deze handleiding niet worden opgevolgd.
 - Schade is ontstaan door ondeskundige modificaties
 - In deze gevallen vervalt het recht op garantie.

MOTORLINE ELECTROCELOS SA.

Travessa do Sobreiro, nº29
4755-474 Rio Côvo (Santa Eugénia)
Barcelos, Portugal

SYMBOLLEN LEGENDA:



• Belangrijke veiligheidsvoorschriften



• Potentiometer informatie



• Nuttige informatie



• Informatie over connectoren



• Programmeringsinformatie



• Informatie over knoppen

02. CONTROL BOARD

TECHNICAL SPECIFICATIONS

The MC50SC is a monophasic control board com a control system via incorporated rádio, developed for the automation of sliding gates and sectional doors.

	110V version	230V version
• Power Supply	110Vac 60Hz	230Vac 50-60Hz
• Flashing light's output	110Vac 60Hz 100W max.	230Vac 50Hz 100W max.
• RGB Flashing light's output	24Vdc 100mA max.	
• Motor's output	110Vac 60Hz 1000W max.	230Vac 50-60Hz 1000W max.
• Auxiliary accessories output	24Vdc 8W max.	
• Security and BT Remote controls	24Vdc	
• Working temperature	-25°C to +55°C	
• Incorporated Radio receiver	433,92 Mhz	
• OP Remote controls	12bits or Rolling Code	
• Maximum Memory Capacity	100 (full opening) - 100 (pedestrian opening)	
• Control board Dimensions	105mm x 130mm	

• CONNECTOR'S DESCRIPTION

CN1	01 • Grounding 02 • Grounding 03 • 110/230V Line Input (phase) 04 • 110/230V Line Input (neutral) 05 • 110/230V Motor's Output – Opening 06 • 110/230V Motor's Output – Common 07 • 110/230V Motor's Output - Closing 08 • 110/230Vac Flashing light output 09 • 110/230Vac Flashing light output	CN4	01 • Safety Edge 02 • Photocells 03 • Encoder (not used) 04 • Encoder (not used) 05 • Common
	CN2	01 • Pedestrian push-button input 02 • Total push-button input 03 • Opening limit-switch input (OPEN) 04 • Closing limit-switch input (CLOSE) 05 • Common	CN5
CN3	01 • 24Vdc 200mA max power supply 24V 02 • 24Vdc 200mA max power supply (↓)		

02. CONTROL BOARD

PROGRAMMING PRE-RECOMENDATIONS

To enhance knowledge about the control board operation, before proceeding to the setup, give special attention to the instructions that follow.

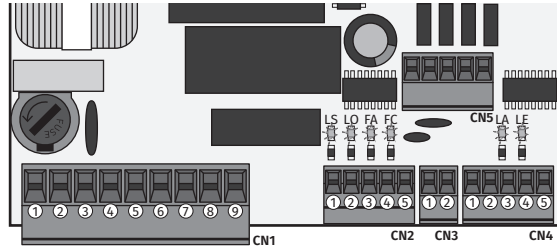

LEDs	<p>LS • LED ON when the pedestrian push button is active.</p> <p>LO • LED ON when the total push button is active.</p> <p>FA • LED off when the opening limit switch is active (P0 -> d1=RT). LED on when the opening limit switch is active (P0 -> d1=LE).</p> <p>FC • LED off when the closing limit switch is active (P0 -> d1=RT). LED on when the closing limit switch is active (P0 -> d1=LE).</p> <p>LA • LED OFF when safety edge is active (when P6 is active).</p> <p>LE • LED OFF when photocells are active (when P5 is active).</p>
CN1	<p>Courtesy light or flashing light:</p> <p>08 and 09 • This output allows connection of a courtesy light or a flashing light (see P8 in page 10B).</p>
CN2	<p>Limit switches:</p> <p>03 and 04 • The control board needs a opening and closing limit-switches connection (both in NC). Activating any of the limit switches causes the movement to stop immediately.</p> <p>The limit-switch thtriggering is visible on the display. OP (opening limit switch activated) and CL (closing limit switch activated). It is mandatory the use of limit switches.</p>
CN4	<p>Safety circuits:</p> <p>01 • This input allows connection of safety edges. The device operates according to programming set in the P6 menu (page 10A).</p> <p>02 • This input allows connection of photocells. The device operates according to programming set in the P5 menu (page 9B). Shunt application is not necessary.</p>
CN5	<p>01 • Auxiliary output for flashing light or 24V DC LED.</p> <p>Open collector for the management of auxiliary functions:</p> <p>02 • The Y output is activated in intermittent mode, only with the closed gate.</p> <p>03 • The R output is activated in intermittent mode, only in closing phase.</p> <p>04 • The G output is activated in intermittent mode, only in opening phase.</p> <p>05 • The B output is activated in intermittent mode, only in pause time.</p>
Jumper	<p>Control board with jumper for motors > 500 watts</p> <p>Control board without jumper for motors <500 watts</p>

03. INSTALLATION

INSTALLATION OF MCONNECT LINK (OPTIONAL)

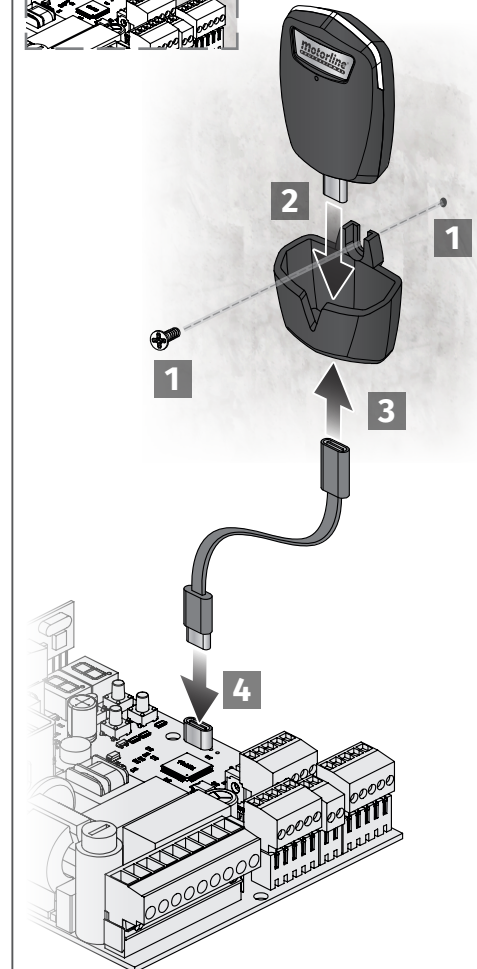
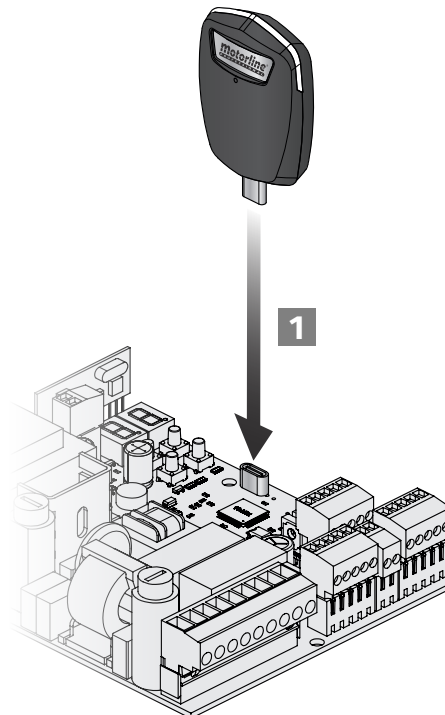
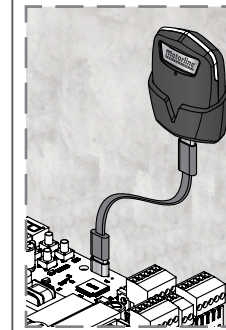
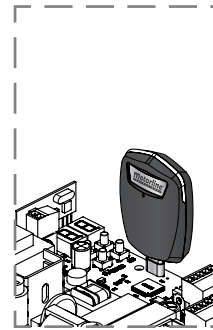

03. INSTALLATION

ESSENTIAL STEPS FOR INSTALLATION



The installation process assumes that the gate has already limit switches plates installed. For more information consult the motor's manual.

- 01 • Make the connections of all the accessories according to the connection scheme (page 15/16/17/18).
- 02 • Connect the control board to a 110/230V power supply (3 and 4 - CN1 terminals).
- 03 • Make sure that the gate movement is the same as the one shown on the display:

CL	OP	If the display does not match with the movement of the gate, access to the P0-dI menu and change the gate direction.
CLOSING	OPENING	

- 04 • Check the limit switches, taking into account the indication that appears on the display.
- 05 • Make an automatic course programming - **P0** menu (page 8A).
- 06 • If necessary, adjust the gate slowdown time during opening and closing - **P1** menu (page 8B).
- 07 • Adjust the force and sensitivity of the motor - **P2** menu (page 8B).
- 08 • Make an automatic programming of the course again - **P0** menu (page 8A).
- 09 • Enable or disable the use of photocells in the **P5** menu (page 9B).
- 10 • Enable or disable the use of safety edge in the **P6** menu (page 10A).
- 11 • Program a remote control (page 6B).

The control board is now fully configured!
Check the menus from the programming pages in case you wish to configure other features of the control board.

03. INSTALLATION

REMOTE CONTROLS

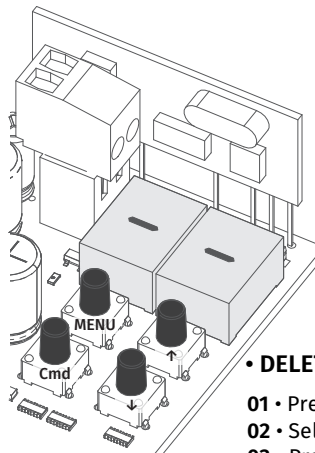

SU Programming a remote control for full opening.

SP Programming a remote control for pedestrian opening.

• REMOTE CONTROL PROGRAMMING

- 01 • Press the **cmd** button for 1 sec.
- 02 • Select the function where you want to program the remote controls (SU and SP) using ↓ ↑.
- 03 • Press **cmd** once to confirm the function (SE or SP).
- 04 • The first free position appears.
- 05 • Press the remote control button you want to program. The display will blink and move to the next free location.

• DELETE REMOTE CONTROLS

- 01 • Press the **cmd** button for 1 sec.
- 02 • Select the function (SU or SP) using ↓ ↑.
- 03 • Press **cmd** once to confirm the function (SU or SP).
- 04 • Use ↓ ↑ to select the remote control location you want to delete.
- 05 • Press **cmd** for 3sec. and the position is empty. The display will flash and the position will be available.

• DELETE ALL THE REMOTE CONTROLS

- 01 • Press the **cmd** button for 5 sec.
- 02 • The display will show **dL**, confirming that all remote controls have been deleted.



- Whenever you store or delete a remote control, the display will flash and show the next position. You can add or delete remote controls without go back to point 01.
- If you do not press any button for 10 seconds the control board will return to standby.

"P" MENU FUNCTIONS

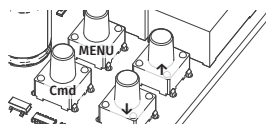

- To access the **P** menu press the MENU button for 3 seconds.
- Use ↓ ↑ to navigate through the menus.
- Press MENU when you want to confirm access to a menu.
- Press ↓ ↑ simultaneously to exit programming.

MENU	FUNCTION	MIN.	MAX.	STATE	FACTORY VALUE	PAGE
P0	Course programming	-	-	<i>RU</i> Automatic programming	-	8A
				<i>nR</i> Semi-automatic programming		
				<i>SC</i> Sliding motor		
				<i>SY</i> SE Sectional motor		
				<i>br</i> Barriers		
				<i>dI</i> LE Reversed motor direction		
<i>rE</i> Standard motor direction						

03. INSTALLATION

"P" MENU FUNCTIONS

MENU	FUNCTION	MIN.	MAX.	STATE	FACTORY VALUE	PAGE
P1	Setting the deceleration time	0	45	dR Opening deceleration	SC: 03 BR: 04 SE: 02	8B
				dF Closing deceleration	SC: 03 BR: 06 SE: 04	
P2	Force and sensitivity adjustment	1	9	F0 Force adjustment	SC, BR, SE: 09	8B
				F5 Sensitivity adjustment	SC, BR: 00 SE: 04	
				Fd Sens. adjustment in deceleration	SC, BR, SE: 00	
P3	Pedestrian course time	1s	99s	Fd Time adjustment in pedestrian mode	SC: 10 BR, SE: 00	9A
P4	Pause time	1s	99s	RF Total closing pause time adjustment	SC, BR, SE: 00	9B
				RP Pedestrian closing pause time adjustment		
P5	Photocells programming	-	-	LE 00 Disables photocells	SC, BR, SE: 00	9B
				01 Activates photocells		
				HC 00 Photocells in closing		
				01 Photocells in opening		
Sc	00 Disables photocell test	SC, BR, SE: 00	-	01 Activates photocell test		
	LR 00 Disables safety edge			SC, BR, SE: 00	-	01 Activates safety edge
HR	00 8k2 input	SC, BR, SE: 01	-			01 NC input
	HL			00 Safety edge in closing	SC, BR, SE: 00	-
SE		00 Disables	SC, BR: 00 SE: 01	-		
	Sc	00 Disables photocell test			SC, BR, SE: 00	-
P7		Operating logic	-	-		
	01 Step by step mode function					
	02 Condominium mode function					
P8	Flashing light	-	-	00 Fixed flashing light	SC, SE, BR: 00	10B
				01 Blinking flashing light		
				02 Courtesy light		
				03 Electromagnet flashing light		
P9	Remote programming	-	-	00 Flashing light lights up whenever opened	SC, SE, BR: 00	11A
				00 Distance PGM OFF		
				01 Distance PGM ON		

SC: Sliding motor; SE: Sectional motor; BR: Barriers

03. INSTALLATION

"E" MENU FUNCTIONS

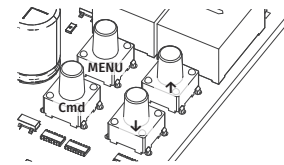

- To access the **E menu** press the MENU button for 10sec.
- Use ↓↑ to navigate through the menus.
- Press MENU when you want to confirm access to a menu.
- Press ↓↑ simultaneously to exit programming.

MENU	FUNCTION	MIN.	MAX.	STATE	FACTORY VALUE	PAGE
E0	Human presence	-	-	00 Deactivates human presence	SC, BR, SE: 00	11B
				01 Ascent and descent in human presence		
				02 Automatic ascent, descent in Human presence		
				HP 00 Deactivate pushbutton operation mode		
				01 Activate pushbutton operation mode	SC, BR: 00 SE: 01	
E1	Soft START and Soft STOP	0	9	F0 Set Soft START value	SC, BR: 00 SE: 05	11B
				Fc Set ramp value for slowing down (Soft STOP)	SC, SE: 00 BR: 05	
E2	Courtesy light time/ Pre-flashing light	0	99	LE Adjustment of courtesy light time	SC, BR, SE: 00	12A
				PP Adjustment of pre-flashing light time	SC, BR, SE: 00	
E3	Follow me	0	9	00 Deactivates follow me	SC, BR, SE: 00	12A
				01 Activates follow me		
E5	Electric brake	-	-	00 Deactivates electric brake	SC, BR, SE: 00	12B
				01 Activates electric brake		
E6	Deceleration speed	1	9	Deceleration speed adjustment	SC, BR, SE: 05	12B
E7	Maneuvers counter	-	-	Shows the number of maneuvers	-	12B
E8	Reset - restore factory values	-	-	00 Deactivated	SC, BR, SE: 00	13A
				01 Reset activated		
E9	RGB output	-	-	00 Fixed RGB	SC, SE: 03 BR: 01	13A
				01 Intermittent RGB		
				02 Pre-Flashing light RGB		
				03 2nd capacitor RGB		

SC: Sliding motor; SE: Sectional motor; BR: Barriers

REMOTE CONTROLS						
SU	Programming a remote control for full opening.	-	-			6B
						6B
SP	Programming a remote control for pedestrian opening.	-	-			6B

04. PROGRAMMING "P"

P0 AUTOMATIC AND SEMI-AUTOMATIC COURSE PROGRAMMING

This menu allows automatic programming of the motor and deceleration.

During automatic programming, the motor will perform the following maneuvers:

- 1^o Slowly close the gate until it reaches the closing limit switch.
- 2^o Slowly opens for about 10 seconds.
- 3^o Slowly closes until it reaches the closing limit switch.
- 4^o The gate opens at normal speed until it reaches the opening limit switch.
- 5^o The gate closes at normal speed until it reaches the closing limit switch.



Steps 2 and 3 are only made if P2-Fd is set to a value equal to or greater than 1. If P2-Fd is set to 0 (zero), you will only do steps 1, 4, and 5.

- 01 • Press MENU for 3 seconds.
- 02 • P0 appears. Press MENU for 1 second.
- 03 • AU appears. Press MENU for 1 second to start automatic programming.
- 04 • When programming is complete, the display returns to the initial state (--).



This menu allows you to program the motor's working time in a semi-automatic way, manually defining the decelerations.
To do this, press MENU at the moment you want to START the slowdown (idling), both in the opening and closing phases.



If you do not press MENU at any time, an automatic programming will be performed without any deceleration.
This programming can be done without limit switches, but it is mandatory to press MENU whenever the gate reaches the end of each course.

- 01 • Press MENU for 3 seconds.
- 02 • P0 appears. Press MENU for 1 second.
- 03 • AU appears. Press ↑ 1 time to show MA.
- 04 • When MA appears, press MENU for 1 second. The motor will start a slow closing of the gate.
- 05 • When it reaches the closing limit switch, it will open automatically.
- 06 • Press MENU when you want to start the opening deceleration.
- 07 • When it reaches the closing limit switch, it will automatically close.
- 08 • Press MENU when you want to start the closing deceleration.



This menu allows you to select the type of automation to be used: SC sliding gate, SE sectional door, BR barriers.

- 01 • Press MENU for 3 seconds.
- 02 • P0 appears. Press MENU for 1 second.
- 03 • AU appears. Press ↑ 2 twice to show SY.
- 04 • When SY appears, press MENU.
- 05 • Select the type of motor you want and press MENU to confirm.

04. PROGRAMMING "P"

P0 AUTOMATIC AND SEMI-AUTOMATIC COURSE PROGRAMMING



With this menu you can change the direction of the motor's movement, without change the connection of the motor wires and limit switches.

- LE • To change the motor's movement direction
- FE • To restore standard motor movement

P1 SETTING THE DECELERATION TIME



It allows to define the slowdown time in the opening phase.

Factory values
SC: 03; BR: 04; SE: 02



It allows defining the slowdown time in the closing phase.

Factory values
SC: 03; BR: 06; SE: 04



When the deceleration is not used, you should adjust the limit switches to be activated slightly before the intended location. This will ensure that the gate does not exceed the stopping point due to movement inertia, which could cause it to get stuck.

- 01 • Press MENU for 3 seconds.
- 02 • P0 appears. Press ↓ once.
- 03 • P1 appears. Press MENU for 1 second.
- 04 • tP appears. Press MENU for 1 second.
- 05 • dA appears. Press MENU for 1 second.
- 06 • Appears the time defined from factory. If you want, change the time from 1 to 45 sec. using ↓ ↑.
- 07 • Press MENU for 1 second, to save the defined time. dF appears. Press MENU for 1 second.
- 08 • Appears the time defined from factory. If you want, change the time from 1 to 45 sec. using ↓ ↑.
- 09 • Press MENU to save the chosen time. P2 appears. To program P2, continue in step 3 from P2 menu (page 8). To exit the programming press ↓ ↑ simultaneously.

P2 FORCE AND SENSITIVITY ADJUSTMENT

If you set the sensitivity (FS) to a value over 1, the force (FO) is automatically set to 9 without the possibility to change it.

Note: If the control board has very high sensitivity values, will show the error LI. After four attempts, the LI error will turn ER.

You will have to wait 10 seconds to return to program the automatism.



It allows to regulate the motor's operation force when opening and closing.

Factory values
SC, BR, SE: 09

04. PROGRAMMING "P"

P2 FORCE AND SENSITIVITY ADJUSTMENT

FS	It allows you to adjust the motor sensitivity in detecting obstacles. The higher the sensitivity the less effort is needed to detect any obstacle and reverse the direction.	 <p>If you activate this function, the force is automatically set to 9.</p>	Factory values SC, BR: 00 SE: 04
FD	It allows you to adjust the sensitivity during the deceleration.	<p>To activate the function, you must make a new programming of the course. This will allow the control board to assume new settings.</p>	Factory values SC, BR, SE: 00

- 01 • Press MENU for 3 seconds.
 - 02 • P0 appears. Press ↓ twice.
 - 03 • P2 appears. Press MENU for 1 second.
 - 04 • F0 appears. Press MENU for 1 second.
 - 05 • Appears the value defined from factory. If you want, change the value from 1 to 9 using ↓ ↑.
 - 06 • Press MENU for 1 second, to save the defined value.
 - 07 • FS appears. Press MENU for 1 second.
 - 08 • Appears the value defined from factory. If you want, change the value from 1 to 9 using ↓ ↑.
 - 09 • Press MENU for 1 second, to save the defined value.
 - 10 • Fd appears. Press MENU for 1 second.
 - 11 • Appears the value defined from factory. If you want, change the value from 1 to 9 using ↓ ↑.
 - 12 • Press MENU, to save the defined value.
 - 13 • P3 appears. To program P3, continue in step 3 from P3 menu (page 9A).
- To exit the programming press ↓ ↑ simultaneously.

P3 PEDESTRIAN COURSE TIME

FD	It allows the gate to be opened for people to pass through, without it being fully opened, you can program the time you want the gate to open.	Factory values SC: 10 BR, SE: 00
----	--	---

 For pedestrian mode work, the minimum working time must be 1 second, where 0 disables the pedestrian mode.

- 01 • Press MENU for 3 seconds.
 - 02 • P0 appears. Press ↓ three times.
 - 03 • P3 appears. Press MENU for 1 seconds.
 - 04 • Appears the time set from factory. If you want, change time between 1 and 99 sec., using ↓ ↑.
 - 05 • Press MENU to save the defined time.
 - 06 • P4 appears. To program P4, continue in step 3 from P4 menu (page 9B).
- To exit the programming press ↓ ↑ simultaneously.

04. PROGRAMMING "P"

P4 PAUSE TIME

AF	Total closing pause time adjustment Allows you to set the waiting time for the gate from when it finishes fully opening until it starts to close.	Factory values SC, BR, SE: 00
AP	Pedestrian closing pause time adjustment Allows you to set the waiting time since finish the pedestrian opening until it starts to close.	

 When the values are set to zero, there is no automatic closing.

- 01 • Press MENU for 3 seconds.
- 02 • P0 appears. Press ↓ four times.
- 03 • P4 appears. Press MENU for 1 second.
- 04 • AF appears. Press MENU for 1 second.
- 05 • Appears the time set from factory. If you want, change time between 1 and 99 sec., using ↓ ↑.
- 06 • Press MENU for 1 second to save the defined time.
- 07 • AP appears. Press MENU for 1 second.
- 08 • Appears the time set from factory. If you want, change time between 1 and 99 sec., using ↓ ↑.
- 09 • Press MENU for 1 second to save the defined time.
- 10 • P5 appears. To program P5, continue in step 3 from P5 menu (page 9B). To exit the programming press ↓ ↑ simultaneously.

P5 PHOTOCELLS PROGRAMMING

LE	00 (disables photocells) 01 (activates photocells) With the photocells activated, when someone interrupts them, the gate reverses the direction set in HC.	
HC	00 (photocells during the closing) 01 (photocells during the opening) This menu can only be changed when the LE menu is active. 00 - photocell only intervenes during closure and reverses in full. 01 - photocell only intervenes in opening and reverses for 2 sec.	Factory values SC, BR, SE: 00
SE	00 (disables photocell test) 01 (activates photocell test)	

- 01 • Press MENU for 3 seconds.
 - 02 • P0 appears. Press ↓ five times.
 - 03 • P5 appears. Press MENU for 1 second.
 - 04 • HE appears. Press MENU for 1 second.
 - 05 • Appears the function set from factory. If you want, change it between 00 and 01 using ↓ ↑.
 - 06 • Press MENU for 1 seconds to confirm the defined function.
 - 07 • HC appears. Press MENU for 1 second.
 - 08 • Appears the function set from factory. If you want, change it between 00 and 01 using ↓ ↑.
 - 09 • Press MENU for 1 seconds to confirm the defined function.
 - 10 • P6 appears. To program P6, continue in step 3 from P6 menu (page 10A).
- To exit the programming press ↓ ↑ simultaneously.

04. PROGRAMMING "P"

P8 SAFETY EDGE

LA	00 (disables safety edge) 01 (activates safety edge) The menu allows you to activate/deactivate its operation.	Factory values SC, BR, SE: 00
HA	00 (8k2 input) 01 (NC input) You can only program HA if it has LA enabled (page 10A). Therefore, you can choose safety edge with 8k2 resistive type (00) or safety edge with normally closed contact, NC (01).	Factory values SC, BR, SE: 01
HL	00 (safety edge during closure) 01 (safety edge during opening) You can only program HL if it has LA enabled (page 10A) and after choose the type of safety edge in HA. In closure (00) the gate reverses, in opening (01) reverses only 2 seconds.	Factory values SC, BR, SE: 00
SE	Activate the STOP button Whenever this parameter is selected, it has priority over any other (example: If LA is active, when activating the STOP button, the input becomes STOP).	Factory values SC, BR, SE: 01
Sc	00 (disables photocell test) 01 (activates photocell test)	Factory values SC, BR, SE: 00



It is recommended to activate the Photocells test before starting operation. This test makes it possible to protect the movement of the gate in case of any failure of the Photocells.

- 01 • Press MENU for 3 seconds.
 - 02 • P0 appears. Press ↓ six times.
 - 03 • P6 appears. Press MENU for 1 second.
 - 04 • LA appears. Press MENU for 1 second.
 - 05 • Appears the function set from factory. If you want, change it between 00 and 01 using ↓ ↑.
 - 06 • Press MENU for 1 second to confirm the defined function.
 - 07 • HA appears. Press MENU for 1 second.
 - 08 • Appears the function set from factory. If you want, change it between 00 and 01 using ↓ ↑.
 - 09 • Press MENU for 1 second to confirm the defined function.
 - 10 • HL appears. Press MENU for 1 second.
 - 11 • Appears the function set from factory. If you want, change it between 00 and 01 using ↓ ↑.
 - 12 • Press MENU for 1 second to confirm the defined function.
 - 13 • ST appears. Press MENU for 1 second.
 - 14 • Appears the function set from factory. If you want, change it between 00 and 01 using ↓ ↑.
 - 15 • Press MENU for 1 second to confirm the defined function.
- P7 appears. To program P7, continue in step 3 from P7 menu (page 10B). To exit the programming press ↓ ↑ simultaneously.

04. PROGRAMMING "P"

P8 OPERATING LOGIC

This menu allows you to set the gate's operating mode.

00	Functioning in automatic mode 1st impulse - OPENS 2nd impulse - STOPS, TIMER AND CLOSES (if P4>00) 3rd impulse - INVERTS	Factory values SC, BR, SE: 02
01	Functioning in step by step mode 1st impulse - OPENS 2nd impulse - STOPS 3rd impulse - CLOSES 4th impulse - STOPS If is fully open and timed, the gate closes	
02	Functioning in condominium mode Does not accept orders during opening and pause time, in closure it reverses (either by remote control or control board start button)	

- 01 • Press MENU for 3 seconds.
 - 02 • P0 appears. Press ↓ seven times.
 - 03 • P7 appears. Press MENU for 1 second.
 - 04 • Appears the function currently set. If you want, change the function to 00, 01 or 02, using ↓ ↑.
 - 05 • Press MENU to save the defined function.
 - 06 • P8 appears. To program P8, continue in step 3 from P8 menu (page 10B).
- To exit the programming press ↓ ↑ simultaneously.

P8 FLASHING LIGHT

00	Blinking flashing light (opening and closing) During the opening/closing movement, the flashing mode will work intermittently.	Factory values SC, BR, SE: 00
01	Fixed flashing light During the opening/closing movement of the gate, the flashing light will remain lit.	
02	Courtesy light During the operation, it converts the flashing light output into courtesy light according to the time defined in E2. (page 12A).	
03	Electromagnet flashing light Its function is to use an electromagnet in the lock so that it is not possible to open the door or barrier. Whenever it is carrying out a closing maneuver or is closed, it remains with the flashing light output activated.	
04	Flashing light lights up whenever opened	

04. PROGRAMMING "P"

P8 FLASHING LIGHT

- 01 • Press MENU for 3 seconds.
- 02 • P0 appears. Press ↓ eight times.
- 03 • P8 appears. Press MENU for 1 second.
- 04 • Appears the function currently set. If you want, change the function to 00, 01, 02 or 03, using ↓ ↑.
- 05 • Press MENU to save the defined function.
- 06 • P9 appears. To program P9, continue in step 3 from P9 menu (page 11A). To exit the programming press ↓ ↑ simultaneously.

P9 REMOTE PROGRAMMING

This menu allows you to enable or disable the new remote controls programming without access directly to the control board by using a previously stored remote control (memorize remote controls page 6B).

00	Distance PGM OFF	Factory values SC, BR, SE: 00
01	Distance PGM ON	

- 01 • Press MENU for 3 seconds.
- 02 • P0 appears. Press ↓ nine times.
- 03 • P9 appears. Press MENU for 1 second.
- 04 • Appears the function currently set. If you want, change the function to 00 or 01, using ↓ ↑.
- 05 • Press MENU to save the defined function.
- 06 • P1 appears. To exit the programming press ↓ ↑ simultaneously.



Distance programming operation (PGM ON):

Press the buttons indicated in the picture at the same time for 10 seconds and the flashing light will start to flash (the display shows the 1st free position). Whenever you memorize a remote control, the control board will leave the distance programming mode. If you want to program more remote controls, you will need to repeat the process of pressing simultaneously the remote control buttons for 10 seconds for each new remote control.

05. PROGRAMMING "E"

E0 HUMAN PRESENCE

	00	Deactivates human presence	Factory values SC, BR, SE: 00	
HP	01	Ascent and descent in Human Presence		
	02	Automatic ascent, descent in Human Presence		
		LS Button	LO Button	Factory values SC, BR, SE: 01
PL	01 ACTIVATED	Total Closing	Total Opening	
	00 DEACTIVATED	Pedestrian maneuvers	Total maneuvers	

- 01 • Press MENU for 6 seconds.
- 02 • E0 appears. Press MENU for 1 second.
- 03 • HP appears. Press MENU for 1 second.
- 04 • Appears the function currently set. If you want, change the function to 00, 01 or 02, using ↓ ↑.
- 05 • Press MENU for 1 second to confirm the defined time.
- 06 • PL appears. Press MENU for 1 second.
- 07 • Appears the function currently set. If you want, change the function to 00 or 01, using ↓ ↑.
- 08 • Press MENU for 1 second to confirm the defined function.
- 09 • E1 appears. To program E1, continue in step 3 from E1 menu (page 11B). To exit the programming press ↓ ↑ simultaneously.

E8 SOFT START AND SOFT STOP

This menu allows to set the values to control the motor movement speed at the beginning and near the end of the course

	80	SOFT START - when activated, at each start of movement, the control board will control the start of the motor, gradually increasing it in the first second(s) of movement.	Factory values SC, BR: 00 SE: 00
	82	SOFT STOP - when activated, at each start of deceleration there will be a gradual decrease in speed so that the speed change is not sudden.	



The Soft Start value must be lower than the deceleration value, in order to avoid delays. Enter the P1 menu to set the slowdown values (page 8B).

- 01 • Press MENU for 6 seconds.
- 02 • E0 appears. Press ↓ once.
- 03 • E1 appears. Press MENU for 1 second.
- 04 • Appears ro or rc. Press MENU once, in the parameter you want
- 05 • If you want, change the function to 00 or 01, using ↓ ↑.
- 06 • Press MENU to save the defined function.

05. PROGRAMMING "E"

E2 COURTESY LIGHT TIME/PRE-FLASHING LIGHT

This menu is only available if the Courtesy Light function is active in menu P8 (see page 11A).

EE	Adjustment of courtesy light time This menu allows you to define the time (from 1 to 99 minutes) that the courtesy light stays on after the gate completes the closing maneuver.	Factory values SC, BR, SE: 00
PP	Adjustment of pre-flashing light time This menu allows you to define the time (from 1 to 99 seconds) that the flashing light remains active before the start of each maneuver.	

- 01 • Press MENU for 6 seconds.
- 02 • E0 appears. Press ↓ twice.
- 03 • E2 appears. Press MENU for 1 second.
- 04 • Appears the time set from factory. If you want, change time between 1 and 99 sec., using ↓ ↑.
- 05 • Press MENU to save the defined time.
- 06 • E3 appears. To program E3, continue in step 3 from E3 menu (page 12A). To exit the programming press ↓ ↑ simultaneously.

E3 FOLLOW ME

This menu allows you to activate the option Follow me. With this function activated whenever the photocells detect the passage of a user/obstacle, the control board triggers the closing operation based on the time selected in this parameter.

To activate Follow me function, P5 have to be set with:
HE=01 / HC=00 (see page 9B)

00	Disabled function	Factory values SC, BR, SE: 00
Values above 0 activate the function (9 is the maximum value)		

- 01 • Press MENU for 6 seconds.
- 02 • E0 appears. Press ↓ three times.
- 03 • E3 appears. Press MENU for 1 second.
- 04 • Appears the function from factory set. If you want, change the function to the desired time, using ↓ ↑.
- 05 • Press MENU to save the defined function.
- 06 • E4 appears (is inactive). To program E5 continue to step 3 of the menu E5 (12B) . To exit the programming press ↓ ↑ simultaneously.



Menu E4 (Encoder) inactive.

05. PROGRAMMING "E"

E5 ELECTRIC BRAKE

With the electronic brake, whenever the gate stops, or is given an order to reverse the movement, the advance decreases, counteracting the inertia exerted by the gate.

Factory values
SC, BR, SE: 00

- 01 • Press MENU for 6 seconds.
- 02 • E0 appears. Press ↓ five times.
- 03 • E5 appears. Press MENU for 1 second.
- 04 • Appears the value currently set. If you want, change the function to 00 or 01, using ↓ ↑.
- 05 • Press MENU to save the defined value.
- 06 • E6 appears. To program E6, continue in step 3 from E6 menu (page 12B). To exit the programming press ↓ ↑ simultaneously.

E6 DECELERATION SPEED

This menu lets you set the deceleration speed in opening and closing.
The higher the level, the faster is the deceleration.

Factory values
SC, BR, SE: 05

- 01 • Press MENU for 6 seconds.
- 02 • E0 appears. Press ↓ 6 times.
- 03 • E6 appears. Press MENU for 1 second.
- 04 • Appears the value currently set. If you want, change the function to 01 or 09, using ↓ ↑.
- 05 • Press MENU to save the defined value.
- 06 • E7 appears. To program E7, continue in step 3 from E7 menu (page 12B). To exit the programming press ↓ ↑ simultaneously.

E7 MANEUVERS COUNTER

This menu allows you to check how many complete maneuvers were performed by the control board (complete maneuver it is understood by opening and closing).

⚠ The control board reset does not erase the maneuvers count.

Example: 13456 maneuvers

01 - Hundreds of thousands / 34 - Thousands / 56 - Dozens

- 01 • Press MENU for 6 seconds.
- 02 • E0 appears. Press ↓ seven times.
- 03 • Press MENU for 1 second.
- 04 • Appears the maneuvers counting in the following order (example 130 371):



- 05 • E8 appears. To program E8, continue in step 3 from E8 menu (page 13A). To exit the programming press ↓ ↑ simultaneously.

05. PROGRAMMING "E"

E8 RESET - RESTORE FACTORY VALUES

By doing reset, all factory settings will be restored.
Only the maneuvers counter will have the data memorised.

Factory values
SC, BR, SE: 00

- 01 • Press MENU for 6 seconds.
- 02 • E0 appears. Press ↓ eight times.
- 03 • E8 appears. Press MENU for 1 second.
- 04 • Appears the function currently set. If you want to reset, change the function to 01, using ↓ ↑.
- 05 • Press MENU for 1 second to reset.
- 06 • E9 appears. To program E9, continue in step 3 from E9 menu (page 13A). To exit the programming press ↓ ↑ simultaneously.

E9 RGB OUTPUT

This menu allows you to select the functioning mode of the four signs (page 10A).

00	Fixed output	Factory values SC, SE: 03 BR: 01
01	Intermittent output	
02	Flashes green for 3 seconds before each maneuver (exit only)	
03	This function only interferes with the "Y" output (all other outputs work normally), activates the capacitor for 2 seconds at each start (extra module)	

- 01 • Press MENU for 6 seconds.
- 02 • E0 appears. Press ↓ nine times.
- 03 • E9 appears. Press MENU for 1 second.
- 04 • Appears the function currently set. If you want, change the function to 00, 02, 03 or 04 using ↓ ↑.
- 05 • Press MENU for 1 second to save the defined function.
- 06 • E1 appears. To exit the programming press ↓ ↑ simultaneously.

06. DISPLAY

DISPLAY INDICATIONS

MENU	DESCRIPTION
00	Motor opening
00	Motor closing
00	In pause time
00	In pedestrian pause time
00	Memory full
00	Memory full (pedestrian)
00	Inversion by effort
00	Obstructed photocells
00	No limit switches or both limit switches in opening
00	Safety edge being pressed
00	Pedestrian button being pressed
00	Start button being pressed
00	Sensibility detection failure
00	Opening limit switch
00	Closing limit switch
00	Control in Pre-Flashing lamp

07. COMPONENTS TEST

CAPACITOR SCHEME

To detect which components have problems during automatism installation, sometimes it's necessary to conduct tests with a direct connection to a 110/230V power supply. For this, it's necessary to interpose a capacitor on the connection so that the motor can work (check the capacitor type to be used in the product's manual). In the below diagram is shown how this connection must be made and how to merge the different component wires.

NOTES:

- To perform the tests you don't need to remove the automatism from its place, because this way you can understand if the automatism, directly connected to the power, can function correctly.
- The order of capacitor wires linked with the automatism wires are not important, as long as you link, one to the Brown wire and the other to the Black one;
- The common wire of the motor must always be connected to the power supply;
- To reverse the automatism functioning direction, switch the Black wire with the Brown wire of the automatism.



For your safety, do not make any changes to the connections without turning off the power supply.
All tests must be carried out by specialized technicians due to the serious danger related to the misuse of electrical systems!

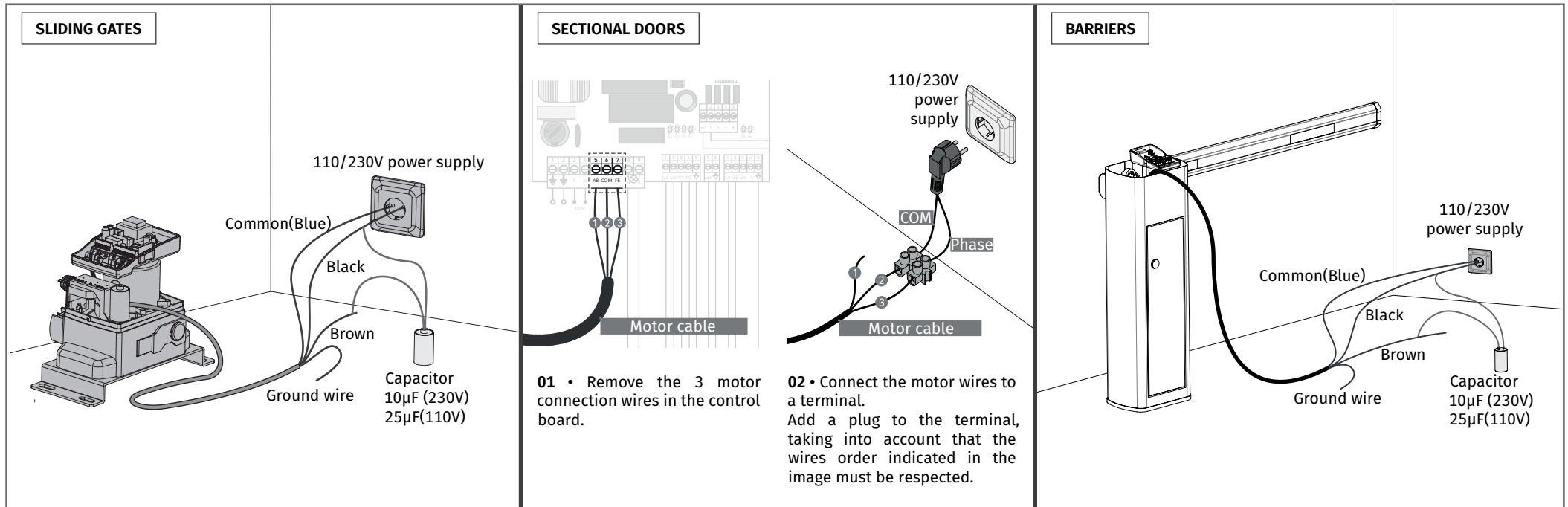

In the position corresponding to each low voltage remote control input, the control board has a signaling LED to identify the status. The LED ON indicates that the input is closed, while the LED off indicates that the input is open.

08. CONNECTION SCHEME

CONNECTIONS SCHEME - SLIDING GATES

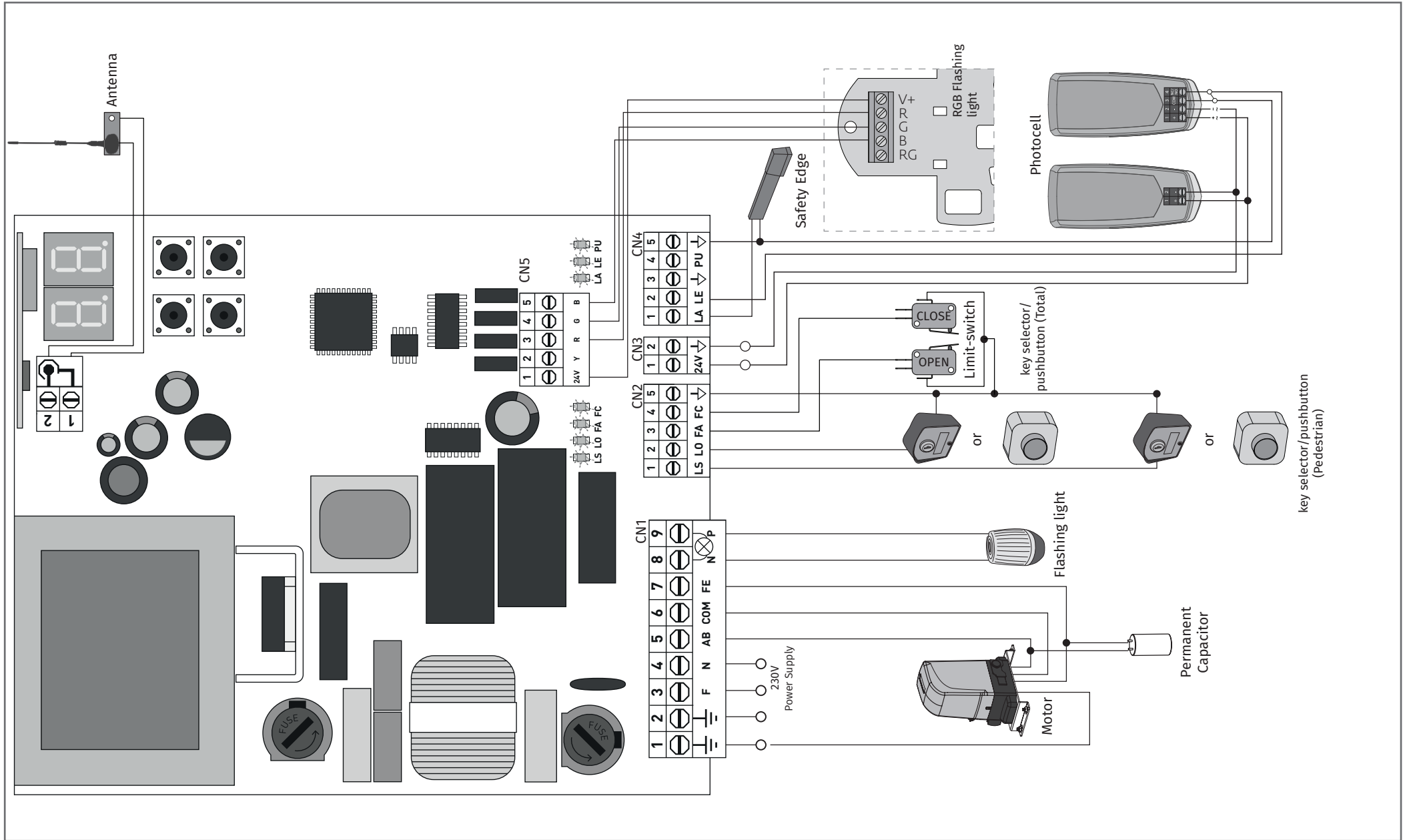

08. CONNECTION SCHEME

CONNECTIONS SCHEME - SECTIONAL DOORS

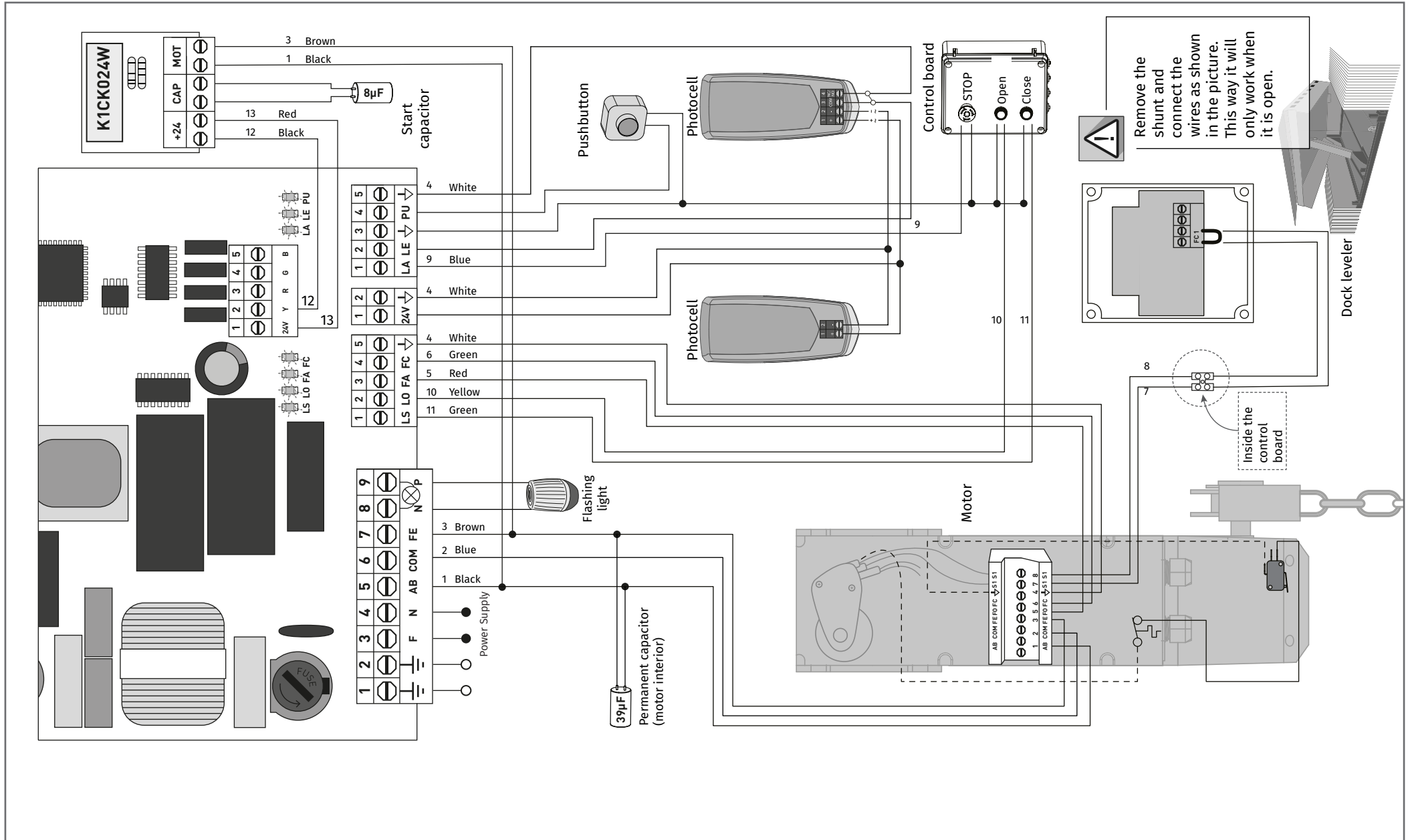

08. CONNECTION SCHEME

CONNECTIONS SCHEME - BARRIERS

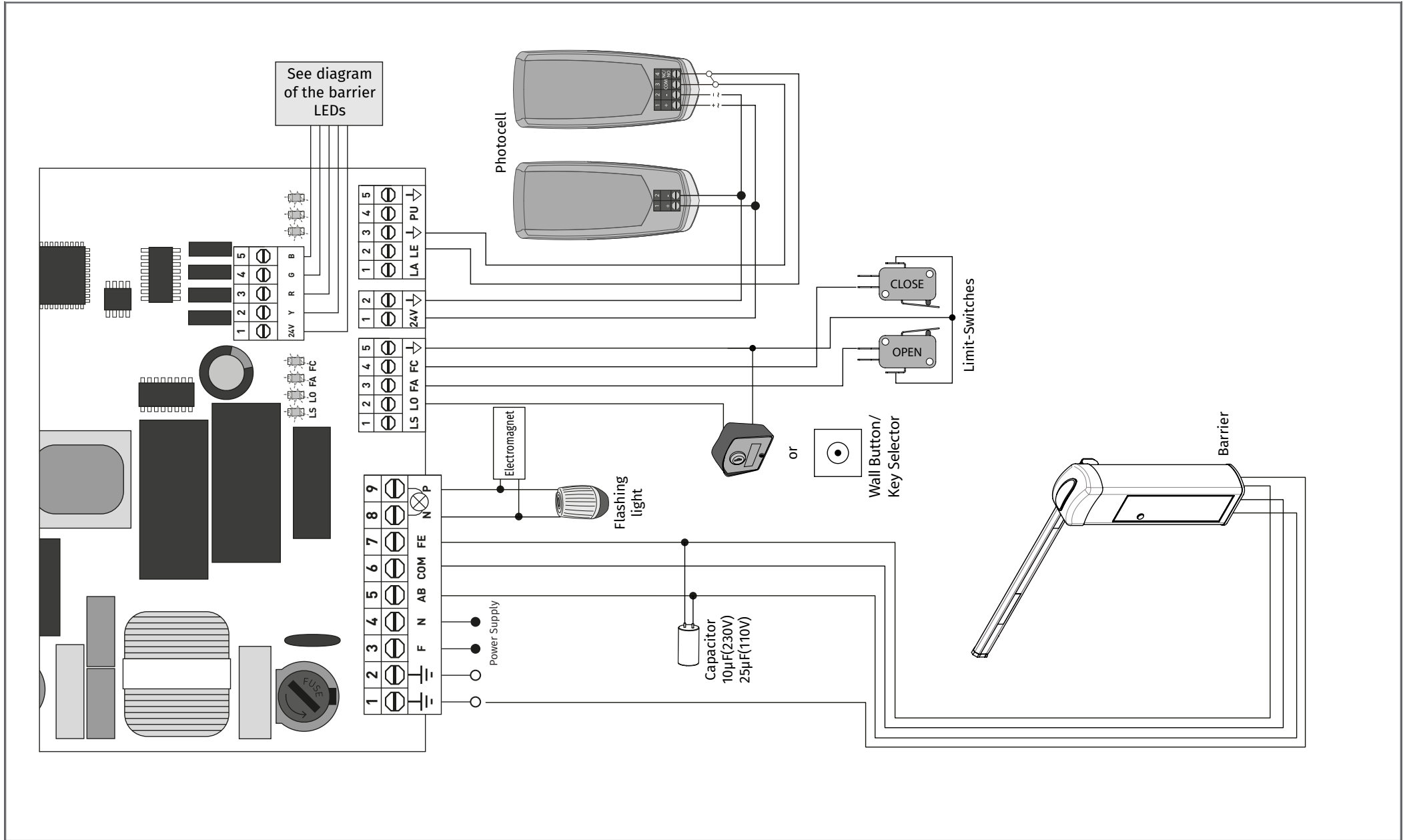

08. CONNECTION SCHEME

CONNECTIONS SCHEME - PHOTOCELLS TEST ACTIVE

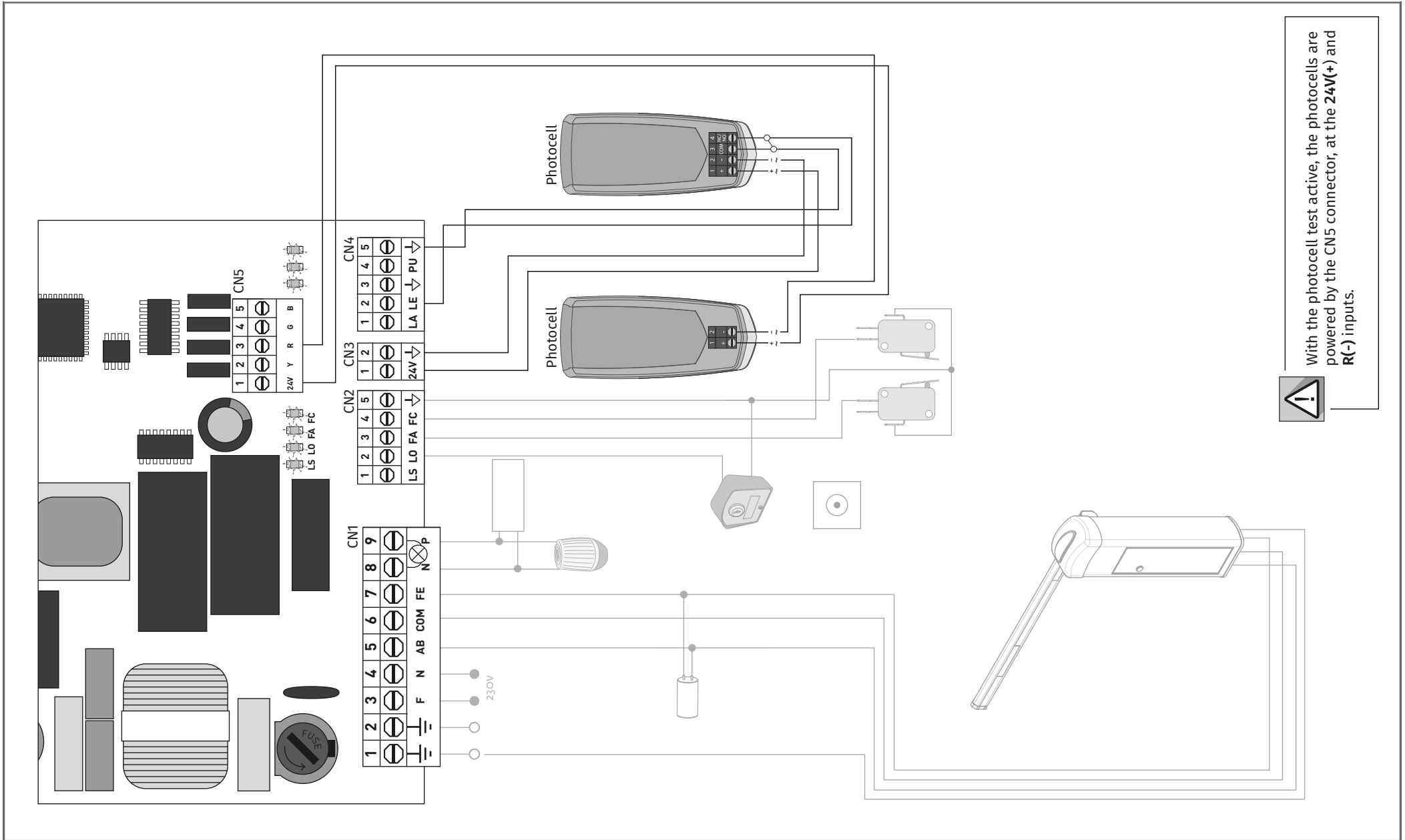

09. TROUBLESHOOTING

INSTRUCTIONS FOR FINAL CONSUMERS/TECHNICIANS

Anomaly	Procedure	Behavior	Procedure II	Discovering the origin of the problem			
• Motor doesn't work	• Make sure you have 110/230V power supply connected to control board and if it is working properly	• Still not working	• Consult a qualified MOTORLINE technician.	1 • Open control box and check if it has 110/230V power supply. 2 • Check the control board input fuses.	3 • Switch off the control board from the motor and test it connected directly to an external power supply to find out if it is faulty (see page 14).	4 • If the motor works, the problem is in the control board. Remove it and send it to MOTORLINE technical services for diagnosis.	5 • If the motor doesn't work, remove it from the installation site and send it to MOTORLINE technical services for diagnosis.
• Motor doesn't move but makes noise	• Unlock motor and move the gate by hand to check for mechanical problems on the movement.	• Encountered problems?	• Consult a qualified gates technician.	Check all axes and movement systems associated with the gate/barrier (pins, hinges, etc.) to find out what the problem is.			
		• The gate moves easily?	• Consult a qualified MOTORLINE technician.	1 • Check capacitors, testing with new capacitor.	2 • If capacitors are not the problem, disconnect motor from control board and it them by connecting directly to power	supply in order to find out if it has problems (see page 14). 3 • If the motor doesn't work	remove them from installation site and send to our MOTORLINE technical services for diagnosis.
• Motor opens but doesn't close	• Unlock motor and move the gate by hand to closed position. Lock motor again and turn of power supply for 5 seconds. Reconnect it and send order to open gate using remote control.	• The gate moves easily?	1 • Check if there is any obstacle in front of the photocells; 2 • Check if any of the control devices (key selector, push button, video intercom, etc.) of the gate are jammed and sending permanent signal to control board; 3 • Consult a qualified MOTORLINE	All MOTORLINE control boards have LEDs that allow you to easily conclude which devices are faulty. All safety device (DS) LEDs in normal situations remain lit. All LEDs of "START" circuits in normal situations remain OFF. If the device LEDs are not all on, there is a fault in the security systems (photocells, security edges). If "START" LEDs are ON, there is a remote control issuing device emitting a permanent signal.	A) SECURITY SYSTEMS: 1 • Close with a shunt all safety systems on the control board (check manual of the control board in question). If the automated system starts working normally check for the problematic device. 2 • Remove one shunt at a time until you find the malfunction device. 3 • Replace it for a functional device and check if the motor works correctly with all the other devices. If you	find another one defective, follow the same steps until you find all the problems. B) START SYSTEMS: 1 • Disconnect all wires from START connector (PUL and PED). 2 • If the LED turned Off, try reconnecting one device at a time until you find the defective device.	NOTE: In case procedures described in sections A) and B) don't result, remove control board and send to our technical services for diagnosis.
• Motor doesn't make complete route	• Unlock motor and move gate by hand to check for mechanical problems on the gate.	• Encountered problems?	• Consult a qualified gates technician.	Check all axes and movement systems associated with the gate/barrier (pins, hinges, etc.) to find out what the problem is.			
		• The gate moves easily?	• Consult a qualified MOTORLINE technician.	1 • Check capacitors, testing with new capacitors. 2 • If capacitors are not the problem, disconnect the motor from the control board and test the motor directly to the power supply to find out if it is faulty. 3 • If the motor doesn't work, remove it from installation site	and send to our MOTORLINE technical services for diagnosis. 4 • If L1 appears on the display while the motor is running, it means that the motor has stopped by effort detection. Unlock the motor and move the gate manually, checking if there is any blockage to its movement. If the motor moves	normally, you need to adjust the force and sensitivity through the P2 menu. 5 • If this doesn't work, remove control board and send it to MOTORLINE technical services.	NOTE: Tuning the force of the control board must be enough to open and close the gate without stopping it, but with a little effort from a person to stop it. In case of failure of the security systems, the gate can never cause physical damage to obstacles (vehicles, people, etc).