



EN54-5A28

v.1.1

EN54 27,6V/5A/2x28Ah power supply for fire alarm systems

EN**

Edition: 5 from 31.01.2019



















Supersedes the edition: 4 from 12.01.2016

LED Version

RED POWER



TABLE OF CONTENTS

1. PSU FEATURES:	4
2. PACKAGE CONTENTS.	5
3. FUNCTIONAL REQUIREMENTS OF THE PSU.	6
4. TECHNICAL DESCRIPTION.	7
4.1. GENERAL DESCRIPTION.	7
4.2. BLOCK DIAGRAM.....	7
4.3. DESCRIPTION OF COMPONENTS AND POWER SUPPLY TERMINALS.	8
5. INSTALLATION	11
5.1. REQUIREMENTS.....	11
5.2. INSTALLATION PROCEDURE.....	12
6. FUNCTIONS	13
6.1. CONTROL PANEL.....	13
6.2. MAIN MENU.....	14
6.2.1. Voltage indicator „Uo1”, „Uo2” 	15
6.2.2. Total current of the receivers indicator „Io” 	15
6.2.3. Resistance of the battery circuit indicator „bre” 	15
6.2.4. Battery temperature indicator „t°C” 	15
6.2.5. 230 V mains voltage indicator „UAC” 	15
6.2.6. Failure history “FLh” 	15
6.2.7. Current failures „FLc” 	16
6.2.8. List of failure codes and information messages.	17
6.3. PSU CONFIGURATION.....	19
6.3.1. Performing battery test „tSt” 	20
6.3.2. EXTo output ON/OFF „Eto” 	21
6.3.3. Setting the delay time for EPS output „EPS” 	21
6.3.4. Acoustic indication ON/OFF „bUZ” 	22
6.3.5. LED Display Dimmer „dIS” 	23
6.3.6. Setting the communication address Adr”   applies to cooperation with PowerSecurity.....	24
6.3.7. Setting the transmission speed „trS”   applies to cooperation with PowerSecurity.....	24
6.3.8. Setting the parity of the transmission “trP”   applies to cooperation with PowerSecurity.....	25
6.4. TECHNICAL OUTPUTS.	26
6.5. INPUT OF COLLECTIVE FAILURE: EXT1.	27
6.6. INDICATION OF THE ENCLOSURE OPENING - TAMPER.	28
6.7. INCREASING THE NUMBER OF OUTPUTS WITH OPTIONAL EN54-LB4 OR EN54-LB8 FUSE MODULES.....	28
6.8. OVERVOLTAGE PROTECTION OF THE PSU OUTPUT OVP.	29
6.9. PSU OVERLOAD.	29
6.10. INDICATION OF EXCEEDING I _{MAX} A CURRENT.	29
6.11. SHORT-CIRCUIT OF THE PSU OUTPUT.	29

7. RESERVE POWER SUPPLY CIRCUIT.	30
7.1. BATTERY DETECTION.	30
7.2. PROTECTION AGAINST SHORT-CIRCUIT OF THE BATTERY TERMINALS.....	30
7.3. PROTECTION AGAINST REVERSE BATTERY CONNECTION.	30
7.4. DEEP DISCHARGE BATTERY PROTECTION UVP.....	30
7.5. BATTERY TEST.	30
7.6. MEASUREMENT OF THE RESISTANCE OF THE BATTERY CIRCUIT.	30
7.7. BATTERY TEMPERATURE MEASUREMENT.	31
7.8. STANDBY TIME.	31
8. REMOTE MONITORING (OPTIONS: WI-FI, ETHERNET, RS485, USB).....	32
8.1. COMMUNICATION VIA THE USB-TTL INTERFACE.	32
8.2. ETHERNET NETWORK COMMUNICATION.	32
8.3. THE WI-FI WIRELESS COMMUNICATION.	33
8.4. RS485 NETWORK COMMUNICATION.	34
8.5. „POWERSECURITY” PROGRAM.	35
9. TECHNICAL PARAMETERS.....	37
<i>Table 12. Electrical parameters.</i>	<i>37</i>
<i>Table 13. Mechanical parameters.</i>	<i>38</i>
<i>Table 14. Safety of use.....</i>	<i>38</i>
<i>Table 15. Recommended types and sections of installation cables.</i>	<i>38</i>
10. TECHNICAL INSPECTIONS AND MAINTENANCE.....	39

1. PSU features:

- In accordance with standards: EN 54-4, EN12101-10
- 27,6 V DC/ 5 A uninterruptible power supply
- battery housing for two 28 Ah/12 V batteries
- independently protected outputs AUX1 and AUX2
- high efficiency 84%
- low level of voltage ripple
- microprocessor-based automation system
- intelligent PSU overload protection
- measurement of the resistance of the battery circuit
- automatic temperature-compensated charging
- battery test
- two-stage battery charging process
- accelerated battery charging
- monitoring of the continuity of the battery circuit
- monitoring of the battery voltage
- monitoring of the battery fuse
- monitoring of charging and maintenance of the batteries
- deep discharge battery protection (UVP)
- battery overcharge protection
- battery output protection against short-circuit and reverse connection
- monitoring of the load current
- output voltage control
- fuse monitoring of AUX1 and AUX2 outputs
- ~230 V mains supply voltage measurement
- „SERIAL” communication port with implemented MODBUS RTU protocol
- Power Security" is a free application for remote monitoring of power supplies (for PC and Android Phones)
- remote monitoring (options: WiFi, Ethernet, RS485, USB)
- remote battery test (additional modules required)
- cooperation with optional EN54-LB4 or EN54-LB8 fuse modules
- optical indication of PSU overload OVL
- acoustic indication of failure
- adjustable delay for ~230 V power loss indication
- relay output of collective failure ALARM
- input of collective failure EXTi
- controlled relay output EXTo
- technical inputs/outputs with galvanic isolation
- EPS technical output indicating ~230 V power loss
- PSU technical output indicating PSU failure
- APS technical output indicating battery failure
- internal memory of PSU operating status
- optical indication – LED panel
 - output current readings
 - output voltage readings: AUX1, AUX2
 - resistance of the battery circuit
 - ~230 V mains voltage readings
 - failure codes with history
- protections:
 - SCP short-circuit protection
 - OLP overload protection
 - OHP overheat protection
 - OVP overvoltage protection
 - Surge protection
 - Antisabotage protection - Tamper
- closing the enclosure - lock
- convection cooling
- warranty - 5 years from the production date

2. Package contents.

- Power Supply Unit
- User manual
- Red mounting spacers – 4 pieces
- Red, metal mounting brackets for hanging the power supply – 4 pieces
- M8x16 mounting screws – 4 pieces
- PG9 cable glands – 4 pieces
- PG11 cable glands – 4 pieces
- Battery serial connection cable
- Keys to lock the power supply– 2 pieces
- Cable tie 190x4,8 – 12 pieces

3. Functional requirements of the PSU.

The buffer power supply for fire alarm systems has been designed in accordance with the following standards:

- EN 54-4:2001 and / A2:2007 Fire detection and fire alarm systems.
- EN 12101-10:2007 Smoke and heat control systems.

Functional requirements	Requirements according to standards	PSU EN54-5A28
External Power Supply failure indication	YES	YES
Two independent power supply outputs protected against short-circuit	YES	YES
Temperature-compensated battery charging	YES	YES
Measurement of the resistance of the battery circuit	YES	YES
Low battery indication	YES	YES
Deep discharge battery protection	YES	YES
Protection against short-circuit of the battery terminals	YES	YES
Battery fuse failure indication	YES	YES
Charging circuit failure indication	YES	YES
Low output voltage indication	YES	YES
High output voltage indication	YES	YES
Indication of power supply failure	YES	YES
Overvoltage protection	YES	YES
Short-circuit protection	YES	YES
Overload protection	YES	YES
Output of collective failure ALARM	YES	YES
EPS technical output	YES	YES
APS technical output	YES	YES
PSU technical output	-	YES
Input of an external failure indication EXT _i	-	YES
Controlled relay output EXT _o	-	YES
Remote battery test	-	YES
~230 V mains supply voltage measurement	-	YES
Optical indication – LED display	-	YES
Tamper indicating enclosure opening	-	YES

4. Technical description.

4.1. General description.

The buffer power supply has been designed for an uninterrupted supply of fire alarm systems, smoke and heat control systems, fire protection equipment and fire automatics requiring stabilized voltage of 24 V DC ($\pm 15\%$). The PSU is fitted with two independently protected outputs AUX1 and AUX2, which supply voltage of 27,6 V DC with a total output current:



Continuous operation
Output current $I_{max a}=3,5 A$

Instantaneous operation
Output current $I_{max b}=5 A$

In case of power loss, the PSU switches to battery power, providing uninterruptible power supply. The PSU is enclosed in a metal casing (RAL 3001 - red) with battery housing for two 28 Ah/12V batteries. The PSU works with maintenance-free lead acid batteries made with AGM technology or gel technology.

4.2. Block diagram

The PSU has been manufactured based on a high-efficiency system of DC/DC converter. Applied microprocessor circuit is responsible for the full diagnostics of the PSU parameters and batteries. The figure below shows a flowchart of the power supply, along with selected functional blocks which are essential for the proper functioning of the unit.

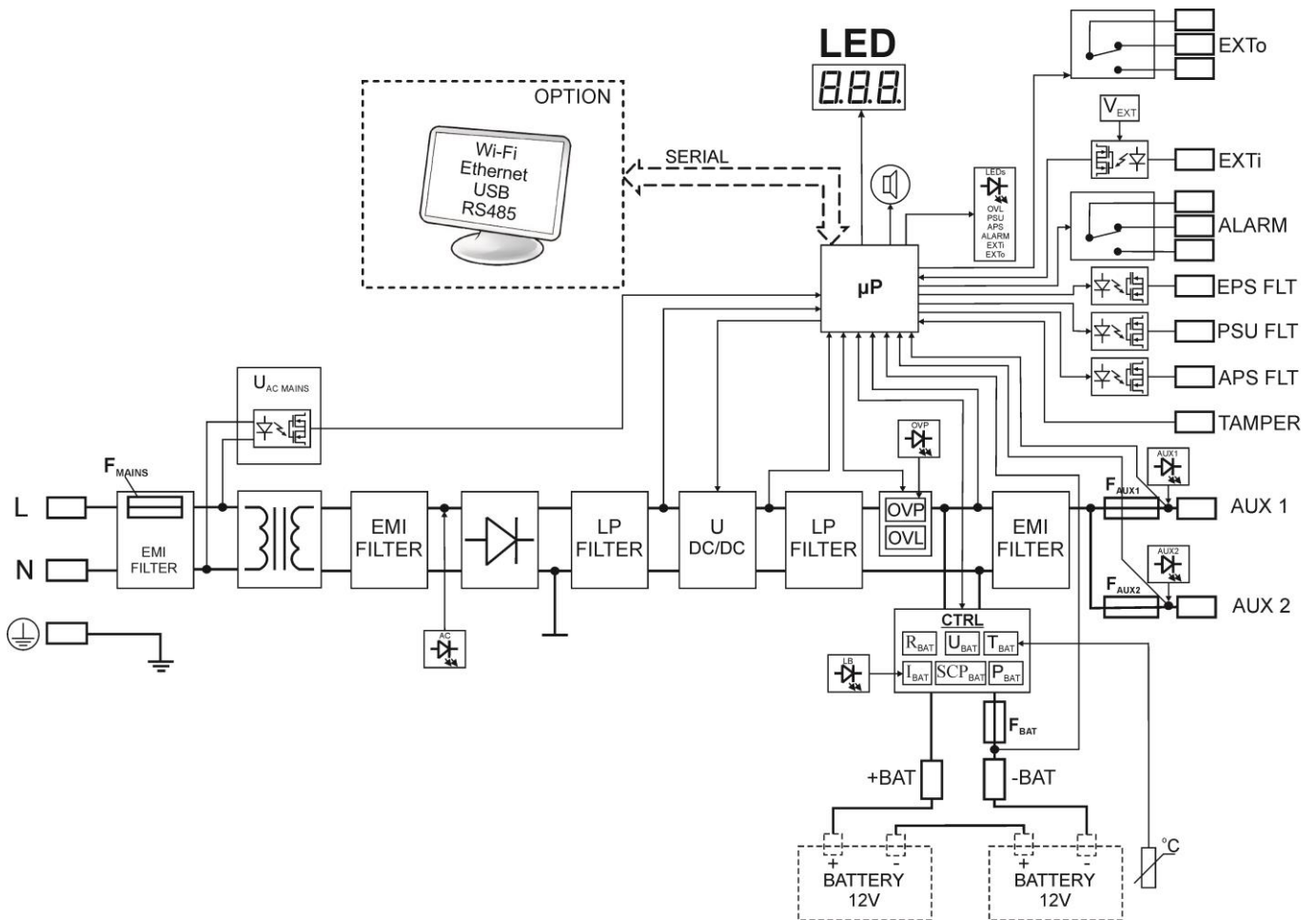

Fig. 1. PSU block diagram.

4.3. Description of components and power supply terminals.

Table 1. Components of the Power supply PCB (Printed Circuit Board) (Fig. 2).

Component No.	Description
[1]	PANEL – optical indication connector
[2]	BUZZER – acoustic indication (see section 6.3.4)
[3]	V_{EXT} jumper – polarization of the EXTi circuit (see section 6.5)
[4]	F_{BAT} – fuse in the battery circuit, F10 A / 250 V
[5]	F_{AUX1} – fuse in the AUX1 output circuit, F6,3 A / 250 V
[6]	F_{AUX2} – fuse in the AUX2 output circuit, F6,3 A / 250 V
[7]	SERIAL – communication port
[8]	Z2 jumper - temporary lock of the battery test (see section 7.5)
[9]	OVP – overvoltage protection optical indication (see section 6.8)
[10]	LEDs – optical indication: AC – AC power AUX1 – AUX1 output voltage AUX2 – AUX2 output voltage OVL – PSU overload APS – battery failure PSU – PSU failure ALARM – collective failure EXTi – EXTi input status EXTo – EXTo relay output status LB – battery charging
[11]	Terminals: ~AC~ – AC power input EPS FLT – technical output of AC power failure indication open = AC power failure closed = AC power - O.K. PSU FLT – technical output of PSU failure indication open = failure closed = PSU operation - O.K. APS FLT – technical output of battery failure open = battery failure closed = battery status - O.K. ALARM – technical output of collective failure of the PSU - relay type CAUTION! In Fig.2 the set of contacts shows a potential-free status of the relay, which corresponds to power supply failure.
[12]	TAMPER – antisabotage protection microswitch connector (see section 6.6)
[13]	Connector – for connecting the EMC filter

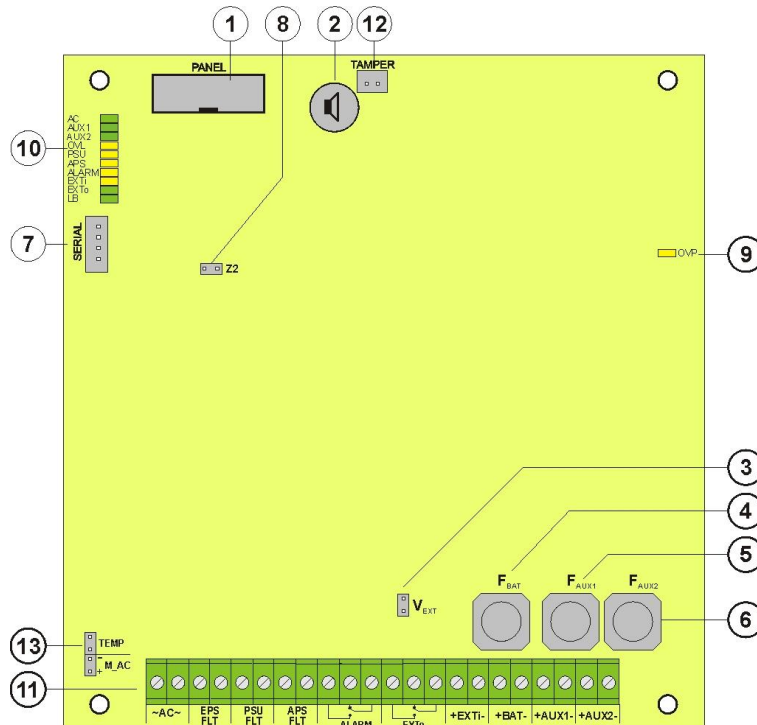



Fig. 2. The view of the PSU's PCB.

Table 2. Components of the PCB of the EMC filter (Fig. 3).

Component No.	Description
①	F_{MAINS} fuse in the power supply circuit 230 V, T6,3 A / 250 V
②	L-N power supply connector 230 V,  protective connector
③	Connector– for connecting the PSU.

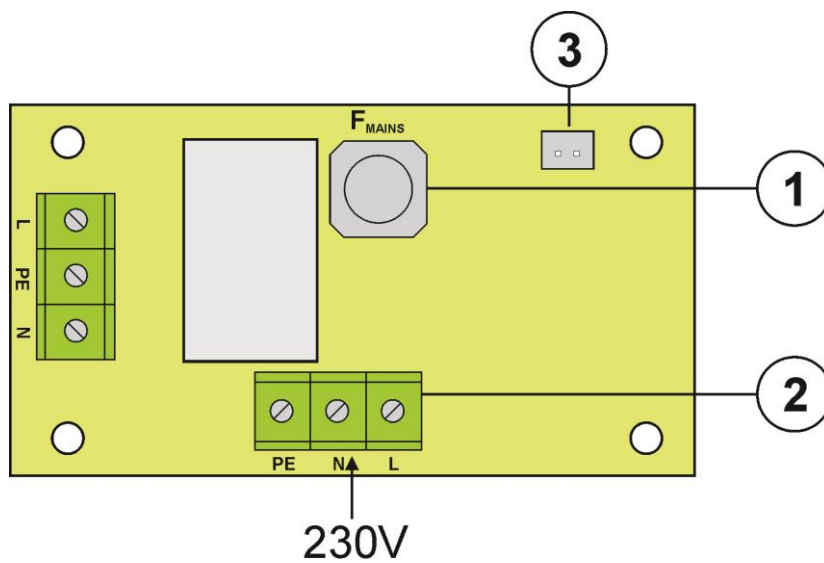

Fig. 3. The view of the EMC filter.

Table 3. Elements of the PSU (Fig. 4).

Component No.	Description
[1]	Isolation transformer
[2]	Printed Circuit Board (see Table 1, Fig. 2)
[3]	Battery temperature sensor.
[4]	Space to install an additional module: "INTR", "INTE", "INTW"
[5]	Place to install the EN54-LB4 or EN54-LB8 fuse module
[6]	TAMPER ; microswitch (contacts) of antisabotage protection (NC)
[7]	EMC filter module (see Table 2, Fig. 3)
[8]	2x28 Ah batteries
[9]	Embossing for cable gland
[10]	Embossing for cable gland (WiFi antenna or cable communication interface)
[11]	Embossings for concealed wires
[12]	Lock
[13]	Battery connectors; positive: +BAT = red, negative: - BAT = black

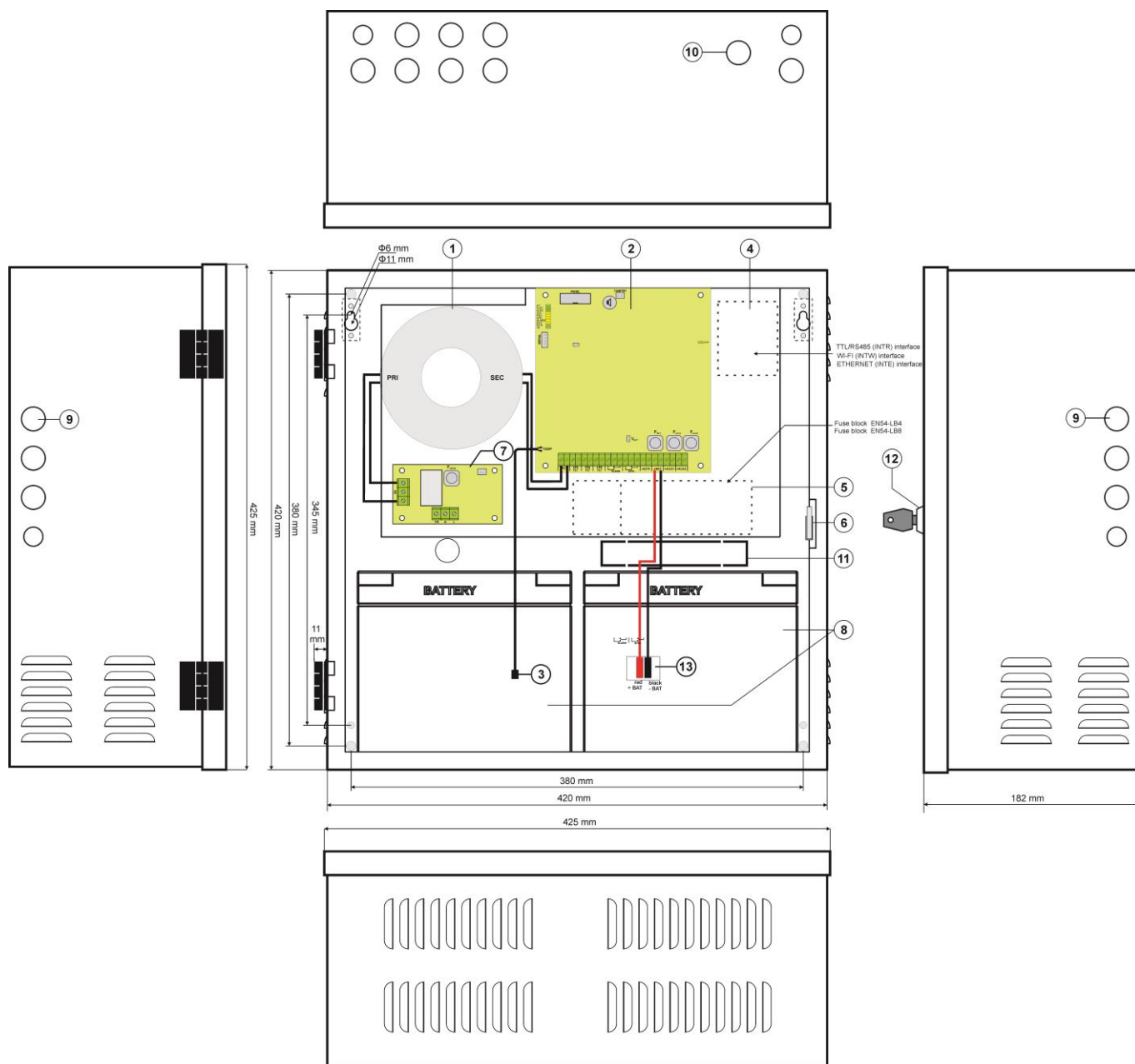

Fig.4. The view of the PSU.

5. Installation.

5.1. Requirements.

The PSU is to be mounted by a qualified installer, holding relevant permits and licenses (applicable and required for a given country) for ~230 V in and low-voltage installations.

As the power supply is designed for a continuous operation and is not equipped with a power-switch, therefore, an appropriate overload protection in the power supply circuit should be provided. Moreover, the user should be informed how to disconnect the power supply unit from the mains supply (usually by assigning an appropriate fuse in the fuse box). The electrical system shall be made in accordance with applicable standards and regulations. The power supply should operate in a vertical position in order to provide free and convectional air flow through ventilating holes of the casing.

As the PSU performs a periodic battery test, measuring the resistance of connections, special attention should be paid to the proper connection of the cables to the batteries. Installation cables should be firmly connected to the battery side terminals and to the power supply connector. If necessary, it is possible to permanently disconnect the battery from the power supply systems by removing the F_{BAT} fuse.

The side walls of the housing include the embossings, which should be used to carry out installation cables. Use a blunt instrument to make an opening for cable gland from the outside of the housing. Then, carefully mount the cable gland, protecting the PSU from water penetration, in the opening.

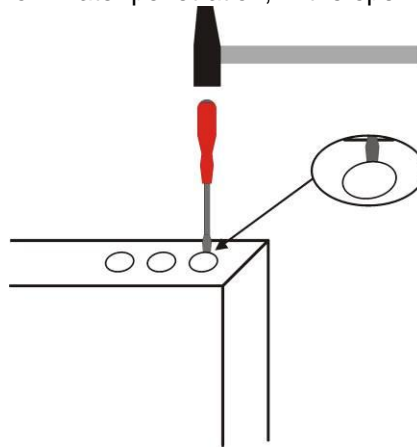

Fig. 5. The method of forming an opening for cable gland.

The PSU is fitted with PG9 and PG11 cable glands. Gland size should be chosen depending on the cross-section of the cable. Single cable gland can be used for only one wire.

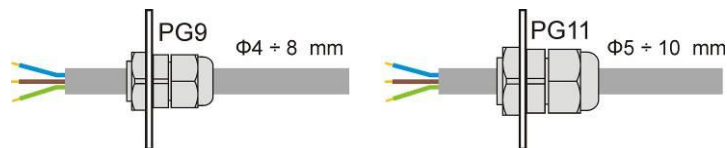

Fig. 6. Recommended types and sections of installation cables PG9 and PG11 for cable glands.

5.2. Installation procedure.



CAUTION!

Before installation, cut off the voltage in the 230 V power-supply circuit.
To switch power off, use an external switch, in which the distance between the contacts of all poles in the disconnection state is not less than 3mm

It is required to install an installation switch with a nominal current of min. 3A in the power supply circuits outside the power supply unit.

1. Mount the PSU in a selected location with use of special metal expansion bolts. Do not use PVC dowels.
2. Connect the power cables (~230 V) to the L-N terminals of the PSU. The cable length inside the housing should not exceed 10 cm. Connect the ground wire to the terminal marked with grounding symbol. Use a three-core cable (with a yellow and green protection wire) to make the connection.



The shock protection circuit shall be done with a particular care: the yellow and green wire coat of the power cable should be connected to the terminal marked with the grounding symbol on the PSU enclosure. Operation of the PSU without the properly made and fully operational shock protection circuit is UNACCEPTABLE! It can cause damage to the equipment or an electric shock.

3. Connect the receivers' cables to the AUX1 and AUX2 output terminals on the PSU board.
4. If needed, connect the cables from the devices to the technical inputs and outputs:
 - ALARM; technical output of collective failure of the PSU
 - EPS FLT; technical output of AC power loss indication
 - PSU FLT; technical output of PSU failure.
 - APS FLT; technical output of the battery failure.
 - EXTi; input of collective failure
5. Install the batteries in a designated area of the enclosure (see Fig. 4). Connect the batteries with the PSU paying special attention to the correct polarity. Batteries must be connected in series using the special cable (included). Attach the temperature sensor to any of the batteries with mounting tape (included).
6. Switch on the ~230 V supply. The corresponding LEDs on the power supply PCB should be ON: green AC and green AUX1 and AUX2. Green LB LED should light up while charging.
7. Check the current consumption of the receivers, taking into account the battery charging current, so as not to exceed the total current efficiency of the PSU (see section 4.1).
8. Once the tests are completed, close the enclosure.

Table 4. Operation parameters.

Environmental class PN-EN 12101-10:2007	2
Operating temperature	-5 °C...+75 °C
Storing temperature	-25 °C...+60 °C
Relative humidity	20 %...90 %, no condensation
Sinusoidal vibrations during operation: 10 ÷ 50 Hz	0,1 G
50 ÷ 150 Hz	0,5 G
Surges during operation	0,5 J
Direct insolation	unacceptable
Vibrations and surges during transport	According to the PN-83/T-42106 standard

Table 5. Factory settings of the PSU.

Delay time for EPS technical output indicating AC power loss	10s	section 6.3.3
Acoustic indication	ON	section 6.3.4
LED display dimmer	OFF	section 6.3.5
EXTo output	OFF	section 6.3.2
Communication address	1	section 6.3.6
Transmission	115.2k 8E1	section 6.3.7 and 6.3.8

6. Functions.









6.1. Control Panel.

The PSU features a panel with buttons and LED display, enabling reading of all the available electrical parameters. The panel buttons are used to select and confirm the parameters, which should be displayed.



Fig. 7. Control panel.

Table 6. The description of the buttons and LEDs of the LED panel.

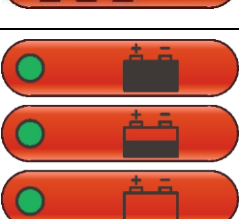
	Description	Additional information
	- moves the pointer on the screen - next screen selection	
	- selection approval	
	- green LED indicating ~230 V voltage	
	- yellow LED indicating exceeding the I _{max} a current or power supply overload	section 6.9, 6.10
	- yellow LED indicating PSU failure	section 6.2.3
	- yellow LED indicating battery failure	
	- yellow LED ALARM indicating collective failure	
	- green LED AUX1 indicating power at the AUX 1 output of the PSU	
	- green LED AUX2 indicating power at the AUX 2 output of the PSU	
	- three green LEDs indicating approximate battery charge level	

6.2. Main menu.

The PSU is equipped with a menu, which allows to preview the current electrical parameters. Diagram explaining the menu structure is presented below

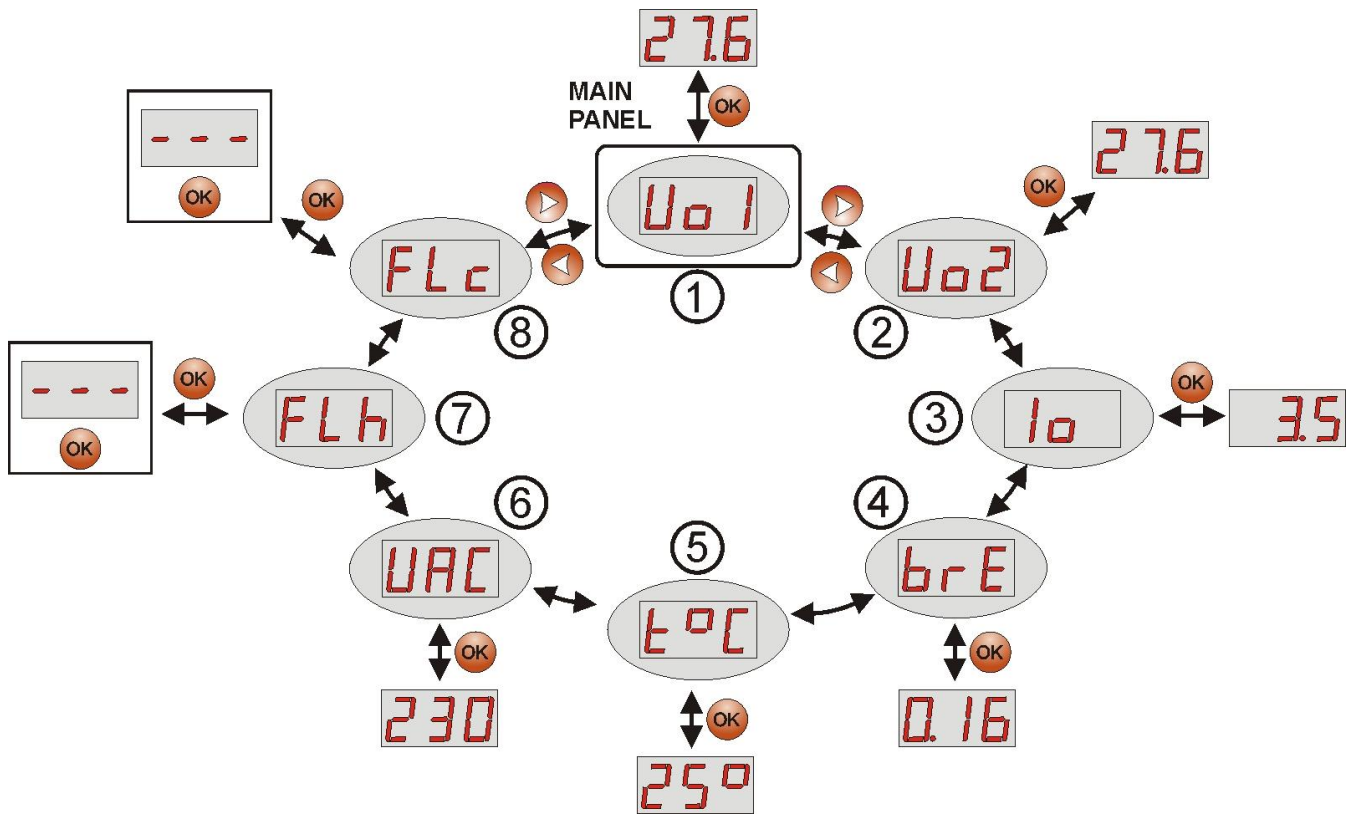



Fig. 8. Menu of the display.

Table 7. The description of display symbols.

	Symbol	Description	Additional information
①	Uo1	AUX1 output voltage [V]	Factory setting: 27,6 V @ 20 °C
②	Uo2	AUX2 output voltage [V]	Factory setting: 27,6 V @ 20 °C
③	Io	Total current of the receivers [A]	$I_o = I_{AUX1} + I_{AUX2}$
④	brE	Resistance of the battery circuit [Ω]	Section 7.6
⑤	t°C	Battery temperature [°C]	Section 7.7
⑥	UAc	Mains supply voltage [V]	230 V mains supply voltage indication
⑦	FLh	Failure history	Section 6.2.6
⑧	FLc	Current failures	Section 6.2.7

6.2.1. Voltage indicator „Uo1”, „Uo2” 

Voltage indicator displays the measured output voltage at the AUX1 and AUX2 outputs. If the voltage drops below 26 V or exceeds 29.2 V, the PSU will indicate a failure.

The resolution of voltage measurement is 0.1 V and should be treated with caution. If a greater accuracy is required, use a multimeter.

6.2.2. Total current of the receivers indicator „Io” 

Total output current indicator displays the measured output current drawn from the AUX1 and AUX2 outputs. If the value of total current is exceeded, the power supply unit will indicate a failure.

$$I_o = I_{AUX1} + I_{AUX2}$$

The resolution of current measurement is 0.1 A and should be treated with caution. If a greater accuracy is required, use a multimeter.

6.2.3. Resistance of the battery circuit indicator „bre” 

Resistance of the battery circuit indicator displays the measured resistance of the battery circuit of the PSU. The resistance value is affected by:

- The quality of the batteries
- The quality of the battery cables and connections
- The quality of the FBAT fuse

If the resistance value increases above 300 mΩ, the power supply unit will indicate a failure. The measurement result is displayed with a resolution of 0.01 ohm.

6.2.4. Battery temperature indicator „t°C” 

Battery voltage indicator displays the measured temperature of the batteries. The temperature is used by the automatic control system for compensation of the battery charging voltage.

The measurement result is displayed with a resolution of 1°C.

6.2.5. 230 V mains voltage indicator „UAC” 

230 V mains voltage indicator displays the measured mains voltage at the ~230 V mains terminals. If the voltage drops below 195 V AC or exceeds 254 V AC, the power supply unit will indicate a failure.

The resolution of current measurement is 1 V and should be treated with caution. If a greater accuracy is required, use a multimeter.

6.2.6. Failure history “FLh” 

The PSU remembers 30 last failures in non-volatile memory, which can be reviewed later.

In order to review the failures, use the "<" or ">" button to set the **FLh** parameter and confirm by pressing "OK". The display will show the number of failure in the memory and its code. Pressing the "OK" button again will display next failure in the memory.



The memory of the new power supply remembers the events that are the result of the efficiency tests carried out at the production stage.

- press „<” or „>” button to set the „FLh” parameter on the display



- press „OK” button

- number 1, indicating the number of failure in the memory (the highest priority), will be displayed. Then, after one second, failure code will be displayed automatically



- press „OK” button

- the number 2, denoting the next number of failure in the memory, will be displayed. Then, after one second, the next failure code will be displayed automatically



- if the memory has more failures, pressing the "OK" button will result in displaying subsequent codes



- The „- - -” parameter on the display marks the end of the list of failures

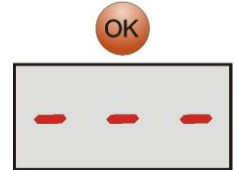

6.2.7. Current failures „FLc”



In case of abnormal electrical parameters, the power supply provides optical and acoustic indication of the failure via corresponding LED and a beeper (if not disabled).

The PSU can simultaneously indicate several failures. Thanks to this solution, codes of all failures and their priority can be previewed in the **FLc** menu. In the **FLc** menu, each press of the "OK" button on the panel displays the next error code that caused the failure. If there are multiple failures at the same time, pressing the "OK" button will display the next code. The display order of failures is arranged by priority of importance. The first failures in the display order are of the highest priority.

Section 6.2.8. summarizes all the failure codes that may occur during the power supply operation. The individual codes are accompanied by appropriate optical indication on the panel, acoustic indication and activation of the dedicated technical output.

- press „<” or „>” button to set the „FLc” parameter on the display



- press „OK” button



- the number 1, indicating the number of failure in the memory (the highest priority), will be displayed. Then, after one second, failure code will be displayed automatically

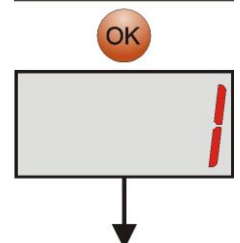

- press „OK” button

- the number 2, denoting the next number of failure in the memory, will be displayed. Then, after one second, the next failure code will be displayed automatically

- if the memory has more failures, pressing the "OK" button will result in displaying subsequent codes

- The „- - -” parameter on the display marks the end of the list of failures

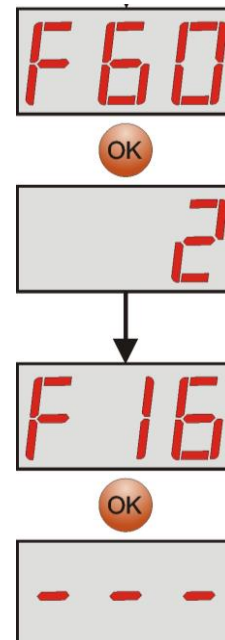

6.2.8. List of failure codes and information messages.

The PSU indicates the operation status with the appropriate code. The codes are divided into two groups, marked with the initial letters "F" or "I".

The codes beginning with the letter "F" indicate a failure. The codes that begin with the letter "I" indicate the correct operation of the PSU or repaired fault, involving, for example, fuse replacement: "I03 - BAT fuse replaced".

Table 8. List of PSU failure codes.

Failure code	Information	Technical output activation	Causes	Additional information
F01	AC power fail!	EPS FLT, ALARM	- No AC mains supply - F _{MAIN} fuse failure	
F02	AUX1 fuse fail! AUX2 fuse fail!	PSU FLT, ALARM	- Blown F _{AUX1} fuse - Blown F _{AUX2} fuse	
F03	BAT fuse fail!	APS FLT, ALARM	- Blown F _{BAT} fuse - Short circuit in the battery circuit - Short circuit in the AUX output circuit	
F04	Output overload!	PSU FLT, ALARM	- PSU overload	Section 6.9
F05	Battery undercharged!	APS FLT, ALARM	- Spent batteries - Undercharged batteries	Section 7
F06	High AUX1 voltage! High AUX2 voltage!	PSU FLT, ALARM	- Output voltage over 29.2 V	
F08	Charge circuit fail!	PSU FLT, ALARM	- The output voltage of the PSU set too low, below 26 V - Battery charging circuit failure	
F09	Low AUX1 voltage! Low AUX2 voltage!	PSU FLT, ALARM	- Output voltage below 26 V	
F10	Low battery voltage!	APS FLT, ALARM	- The battery voltage has dropped below 23 V (during battery-assisted operation)	
F11	Low battery volt. – off!	APS FLT, ALARM	- the battery voltage has dropped below 20 V (during battery-assisted operation)	Section 7.4
F12	External input EXT _i !	ALARM	- Activation of the input of collective failure: EXT _i	Section 6.5
F14	Temp. sensor fault!	PSU FLT, ALARM	- Faulty temperature sensor - Temperature sensor disconnected	Section 7.7

F15	High battery temp.!	PSU FLT, ALARM	- Too high ambient temperature of the PSU. - Overloaded batteries. - Faulty batteries.	Section 7.7
F16	No battery!	APS FLT, ALARM	- Disconnected batteries	Section 7.1
F17	Battery fail!	APS FLT, ALARM	- Deeply discharged batteries, voltage below 20 V	Section 7
F18	High batt. circuit resist.!	APS FLT, ALARM	- Spent batteries - Loose cables connecting the batteries	Section 7.6
F19	High AC voltage!	PSU FLT, ALARM	- Mains supply over 254 V AC	Section 6.2.5.
F20	Low AC voltage!	PSU FLT, ALARM	- Mains supply below 195 V AC	Section 6.2.5.
F21	PSU cover opened!	PSU FLT, ALARM		Section 6.6
F50- F54	Internal supply fail!	PSU FLT, ALARM	- service codes	
F60	No communication	PSU FLT, ALARM	- no communication with LCD panel	
F61- F64	Control panel fail	PSU FLT, ALARM	- service codes	
F65	Access unlocked		- passwords unlocked	

Table 9. List of PSU message codes.

Message code	Description
I00	Power supply start-up
I01	AC power back
I02	AUX fuse replaced
	AUX2 fuse replaced
I03	BAT fuse replaced
I04	Battery connected
I05	Battery OK
I06	Battery temperature OK
I07	AC voltage OK
I08	EXTo output ON
I09	EXTo output OFF
I10	Battery test – START
I11	PSU cover closed
I12	I _{max_a} over limit
I13	I _{aux} decr. below I _{max_a}

6.3. PSU configuration.

The PSU is equipped with a configuration menu that allows to configure the settings by changing or the activation of some of its parameters. The figure illustrating the configuration menu structure is shown below.

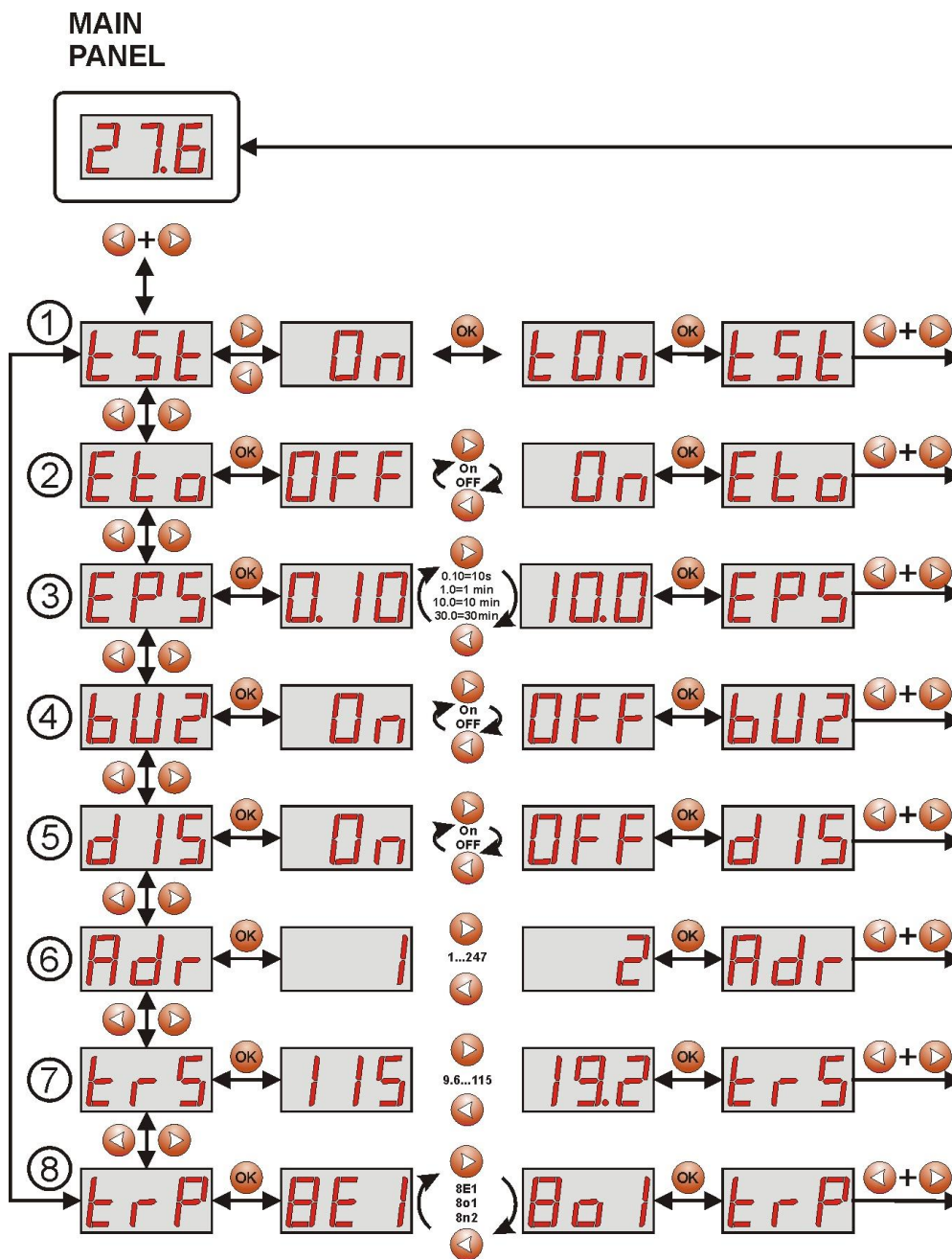









Fig. 9. The PSU configuration menu.

Table 10. Description of symbols.

	Symbol	Description	Additional information
①		Battery test – „tSt” On – battery test activation	Sections 6.3.1 and 7.5
②		EXTo output – „Eto” On – relay on OFF – relay off	Section 6.3.2
③		EPS output delay – „EPS” Setting the delay time for AC power failure indication: 0.10 - 10s (factory setting) 1.0 - 1min 10.0 - 10min 30.0 - 30min	Section 6.3.3
④		Acoustic indication – „bUZ” On – acoustic indication on OFF – acoustic indication off	Section 6.3.4
⑤		LED display dimmer On – dimmer ON OFF – dimmer OFF	Section 6.3.5
⑥		Communication address – „Adr” 1÷ 247 power supply address required at the time of communication with the computer 1 – factory setting	Section 6.3.6
⑦		Transmission – „trS” Determines the speed of communication 9.6k : 115.2k (factory setting)	Section 6.3.7
⑧		Parity of the transmission – „trP” Determines the method of communication 8N2 8E1 (factory setting) 8O1	Section 6.3.8

6.3.1. Performing battery test „tSt”



The "tSt" menu activates the test of the batteries (see section 7.5) connected to the power supply. If the test is negative, it is indicated by the appropriate message, acoustic indication and activation of the APS FLT and ALARM technical outputs.

- simultaneously press the „<,>” rightmost and leftmost buttons on the LED panel

- The „tSt” parameter will be displayed

- press „OK”

- The „On” parameter will be displayed

- press „OK”

- The information about activation of the battery test will be displayed

- once the test is finished, the „tSt” parameter will be displayed

- in order to return to the main menu, simultaneously press the „<,>” rightmost and leftmost buttons on the LED panel

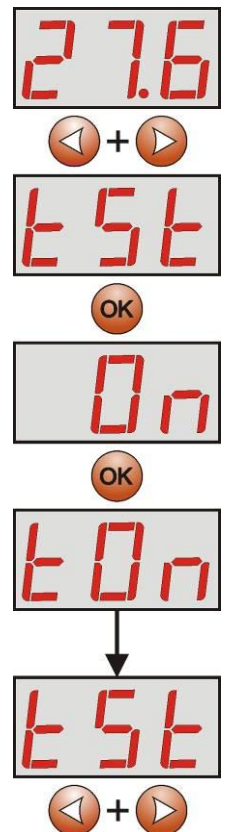

6.3.2. EXTo output ON/OFF „Eto” 

Controlled relay output EXTo (external output) does not depend on the operation of the power supply unit and can be switched independently of its work.

The EXTo output can be used for switching between controlling, resetting and supplying inputs/outputs in low-voltage electrical circuits.

Changes in the EXTo output can be made locally from the panel (see section 6.3.2) or remotely using the PowerSecurity application.

Information about the changes in the EXTo output is written in the event log of the PSU.

- simultaneously press the „<,>” rightmost and leftmost buttons on the LED panel

- the „tst” parameter will be displayed

- use the „<” or „>” buttons to display the „Eto” parameter

- press „OK”

- The current status of the relay will be displayed

- use the „<” or „>” buttons to in order to set the status

- On – relay on
- OFF – relay off

- press „OK” – relay output status is changed

- in order to return to the main menu, simultaneously press the „<,>” rightmost and leftmost buttons on the LED panel

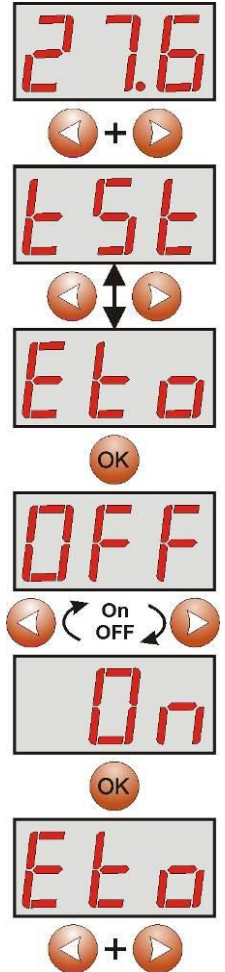

6.3.3. Setting the delay time for EPS output „EPS” 

The PSU features adjustable delay for 230 V power loss indication. The delay time can be selected from the four available ranges:

- 10s (factory setting)
- 1min
- 10min
- 30min

230 V power loss is indicated by the activation of the “EPS FLT” and „ALARM” technical output.

- simultaneously press the „<,>” rightmost and leftmost buttons on the LED panel

- The „tSt” parameter will be displayed

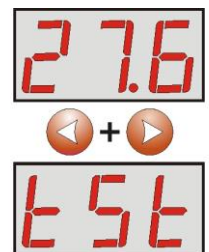

- use the „<” or „>” buttons to display the „EPS” parameter

- press „OK”

- The current status will be displayed

- use the „<” or „>” buttons in order to set the delay time

0.10 - 10s (factory setting)

1.0 - 1min

10.0 - 10min

30.0 - 30min

- confirm by pressing "OK"

- in order to return to the main menu, simultaneously press the „<,>” rightmost and leftmost buttons

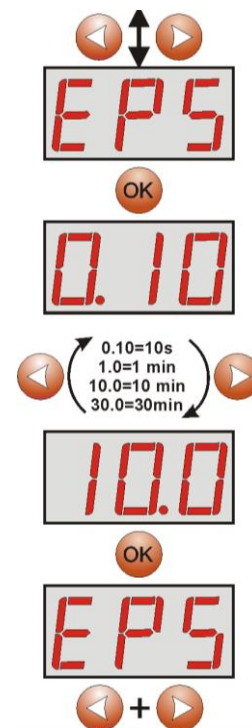

6.3.4. Acoustic indication ON/OFF „bUZ”

Emergency situations that may arise during the operation of the PSU are indicated acoustically. The frequency and number of signals depend on the type of event.

Table 11. Acoustic indication.

No.	Description	Event
1	1 signal every 10s, battery mode	230 V power failure
2	1 signal every 10s, mains operation	Battery failure, undercharged batteries
3	2 signals every 10s, battery mode	Low battery level
4	Fast signals, battery mode	The PSU will be disconnected because of the battery discharge
5	Constant indication	PSU failure [see section 6.2.8]

- simultaneously press the „<,>” rightmost and leftmost buttons on the LED panel

- The „tSt” parameter will be displayed

- use the „<” or „>” buttons to display the „bUZ” parameter

- press „OK”

- The current status will be displayed

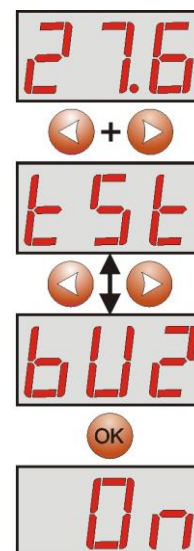

- use the „<” or „>” buttons in order to set the status

On – acoustic indication on
OFF – acoustic indication off

- confirm by pressing "OK"

- in order to return to the main menu, simultaneously press the „<,>” rightmost and leftmost buttons



6.3.5. LED Display Dimmer „dis"

LED display dimmer allows to dim the display if no buttons are pressed within 5 minutes. If the display is in the blackout mode, pressing any button will "reactivate" the display.

- simultaneously press the „<,>” rightmost and leftmost buttons on the LED panel

- the „tSt” parameter will be displayed

- use the „<” or „>” buttons to display the „dis” parameter

- press „OK”

- The current status will be displayed

- use the „<” or „>” buttons in order to set the status

On – dimmer on
OFF – dimmer off

- confirm by pressing "OK"

- in order to return to the main menu, simultaneously press the „<,>” rightmost and leftmost buttons

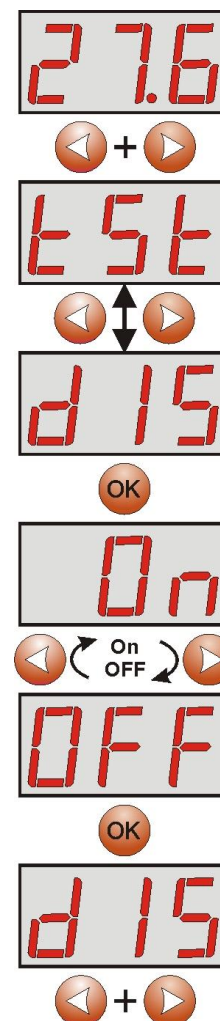

6.3.6. Setting the communication address „Adr”   **applies to cooperation with PowerSecurity.**

 *All power supplies are factory-set to address 1.*

All the parameters responsible for communication between the PSU and the computer, namely the address, parity and speed should have the same settings for both the PSU and the PowerSecurity program. Communication address allows to identify power supply units in the same communication network.

- simultaneously press the „<,>” rightmost and leftmost buttons

- The „tSt” parameter will be displayed

- use the „<” or „>” buttons to display the „Adr” parameter

- press „OK”

- The current address of the PSU will be displayed

- use the „<” or „>” buttons in order to set the address
1 ÷ 247 – address of the PSU during the communication with the computer

- confirm by pressing „OK”

- in order to return to the main menu, simultaneously press the „<,>” rightmost and leftmost buttons

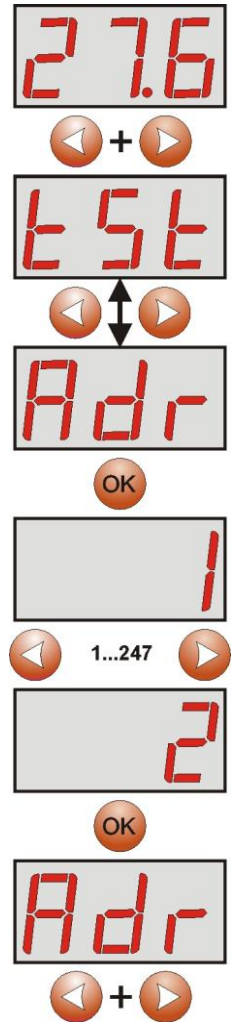

6.3.7. Setting the transmission speed „trS”   **applies to cooperation with PowerSecurity.**

All the parameters responsible for communication between the PSU and the computer, namely the address, parity and speed should have the same settings for both the PSU and the PowerSecurity program.

The PSU has preset transmission parameters of 115200 baud 8E1; if these values were changed, they should be restored to original settings.

- simultaneously press the „<,>” rightmost and leftmost buttons

- The „tSt” parameter will be displayed

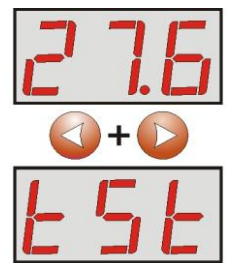

- use the „<” or „>” buttons to display the „trS” parameter

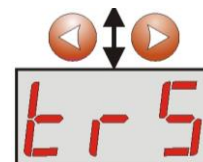

- press „OK”

OK

- The information about the transmission speed will be displayed



- use the „<” or „>” buttons in order to set the required transmission speed,

- 9.6k

⋮

- 115.2k (factory setting)



OK

- confirm by pressing „OK”



- in order to return to the main menu, simultaneously press the „<,”>” rightmost and leftmost buttons



6.3.8. Setting the parity of the transmission “trP” applies to cooperation with PowerSecurity

All the parameters responsible for communication between the PSU and the computer, namely the address, parity and speed should have the same settings for both the PSU and the PowerSecurity program.

The PSU has preset transmission parameters of 115200 baud 8E1; if these values were changed, they should be restored to original settings.

- simultaneously press the „<,”>” rightmost and leftmost buttons



- The „tSt” parameter will be displayed



- use the „<” or „>” buttons to display the „trP” parameter



- press „OK”

OK

- The information about the parity of the transmission will be displayed on the panel



- use the „<” or „>” buttons in order to set the required communication mode,

- 8N2

- 8E1 (factory setting)

- 8O1



OK

- confirm by pressing „OK”



- in order to return to the main menu, simultaneously press the „<,”>” rightmost and leftmost buttons



6.4. Technical outputs.

The PSU is equipped with galvanically isolated indication outputs changing status after a specified event:

- **EPS FLT – output indicating 230 V power loss.**

The output indicates 230 V power loss. Under normal status – with the 230 V supply on, the output is closed. In case of power failure, the PSU will switch the output into the open position after a time lag determined in the „EPS” configuration menu (see section 6.3.3, Table 10).

- **APS FLT – output indicating battery failure.**

The output indicates a failure in the battery circuit. Under normal status (during correct operation) the output is closed. In case of failure, the PSU will switch the output into the open position. Failure can be triggered by the following events:

- faulty batteries
- undercharged batteries
- disconnected batteries
- high resistance of the battery circuit
- battery voltage below 23 V during battery-assisted operation
- battery fuse failure
- no continuity in the battery circuit

- **PSU FLT – output indicating PSU failure.**

The output indicates the PSU failure. Under normal status (during correct operation) the output is closed. In case of PSU failure, it will switch into the open position. Failure can be triggered by the following events:

- $U_{AUX1, AUX2}$ output voltage below 26 V
- $U_{AUX1, AUX2}$ output voltage over 29,2 V
- battery charging circuit failure
- blown F_{AUX1} or F_{AUX2} fuse - exceeding the rated current of the PSU
- activation of overvoltage protection OVP
- mains supply voltage over 254 V AC
- mains supply voltage below 195 V AC
- to high battery temperature ($>65\text{ }^{\circ}\text{C}$)
- temperature sensor failure, $t < -20\text{ }^{\circ}\text{C}$ or $t > 80\text{ }^{\circ}\text{C}$
- enclosure opening - TAMPER
- internal damage of the PSU

The technical outputs have been made with galvanic isolation between the PSU's systems and the attached devices.

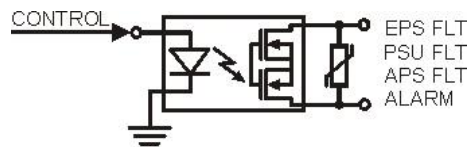

Fig. 10. Electrical diagram of technical outputs.

- **ALARM - technical output of collective failure indication.**

Output indicating collective failure. In the case of failure at any EPS, APS, or PSU output or at the EXTi input, the collective failure signal ALARM will be generated.



CAUTION! In Fig.2 the set of contacts shows a potential-free status of the relay, which corresponds to power supply collective failure of the PSU.

6.5. Input of collective failure: EXTi.

The EXT IN (external input) technical input indicating collective failure is intended for additional, external devices that generate the failure signal. The voltage appearing at the EXT IN input will trigger PSU failure, storing the information about the event in the internal memory and sending the signal about the failure to the ALARM output.

The EXT IN technical input has been made with galvanic isolation between the PSU's systems and the attached devices.

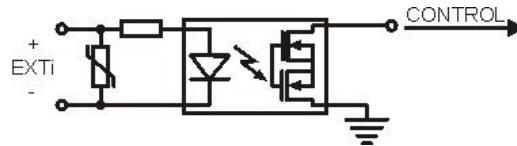

Fig. 11. Electrical diagram of the EXT IN input.

The connection of external devices to the EXT IN input is shown in the electrical diagram below. OC outputs (open collector) or relay outputs can be used as the source of the signal.

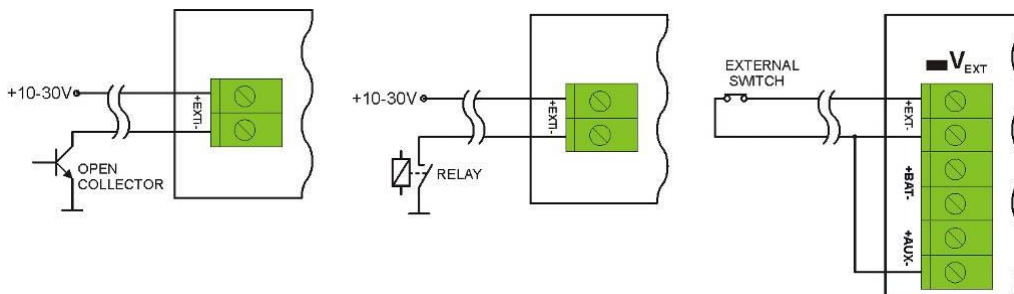

Fig. 12. Examples of connections.

In the option with external switch, the V EXT jumper, which polarises the EXT IN input circuit and is required in such configuration, must be on.

The EXTi input has been adjusted to work with fuse modules generating a failure signal in case of a fuse fault in any of output sections (see section 6.7). To guarantee a correct cooperation between the fuse module and the EXTi input, the connections shall be made as presented in the diagram below and the V EXT jumper must be on.

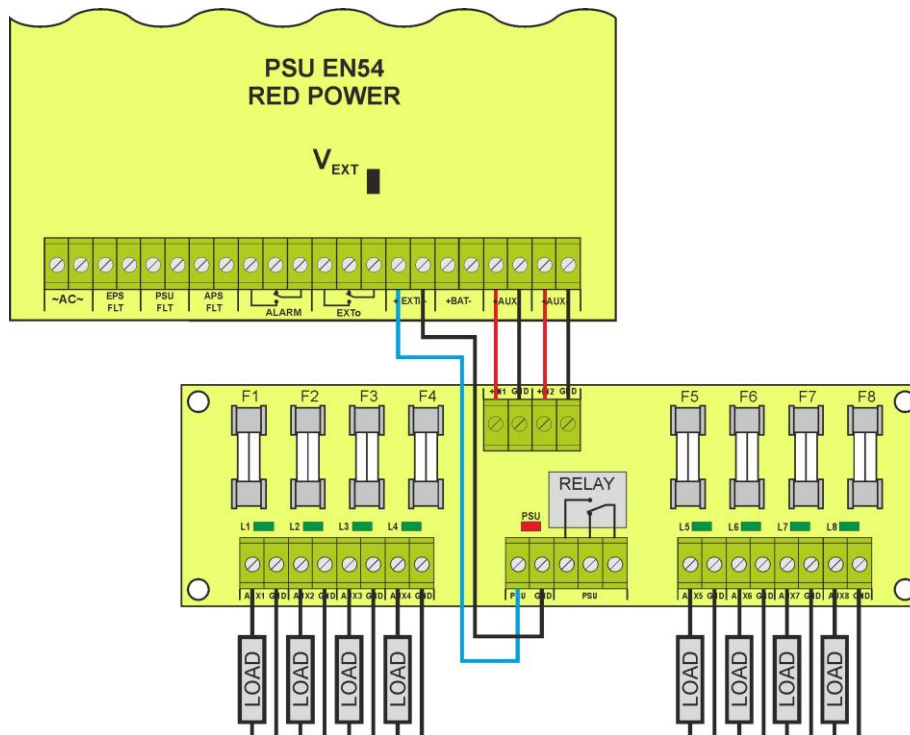

Fig. 13. Example of a connection with the fuse module EN54-LB8.

6.6. Indication of the enclosure opening - TAMPER.

The PSU is fitted with the microswitch tamper indicating enclosure opening.

The tamper cable is not connected to the terminal in the factory settings. In order to activate tamper, remove the jumper from tamper terminal (Fig. 2 [12]) and plug in the tamper cable.

Each opening the enclosure will generate a failure signal at the PSU FLT and ALARM technical outputs and will save the event in the internal memory of the PSU.

6.7. Increasing the number of outputs with optional EN54-LB4 or EN54-LB8 fuse modules.

The PSU has two independently protected outputs for connecting the AUX1 and AUX2 receivers.

If the power supply unit is connected with more receivers, then it is recommended to secure each of them with independent fuse. This solution will protect the power supply system, while the damage to only one receiver (short-circuit on the line) could cause damage to other receivers connected to the same output.

The solution is provided by the optional fuse module EN54-LB4, 4-channel or EN54-LB8, 8-channel, while its mounting location is provided within the housing (see Fig. 4). The figure below shows the connection between the power supply, fuse module and receivers.

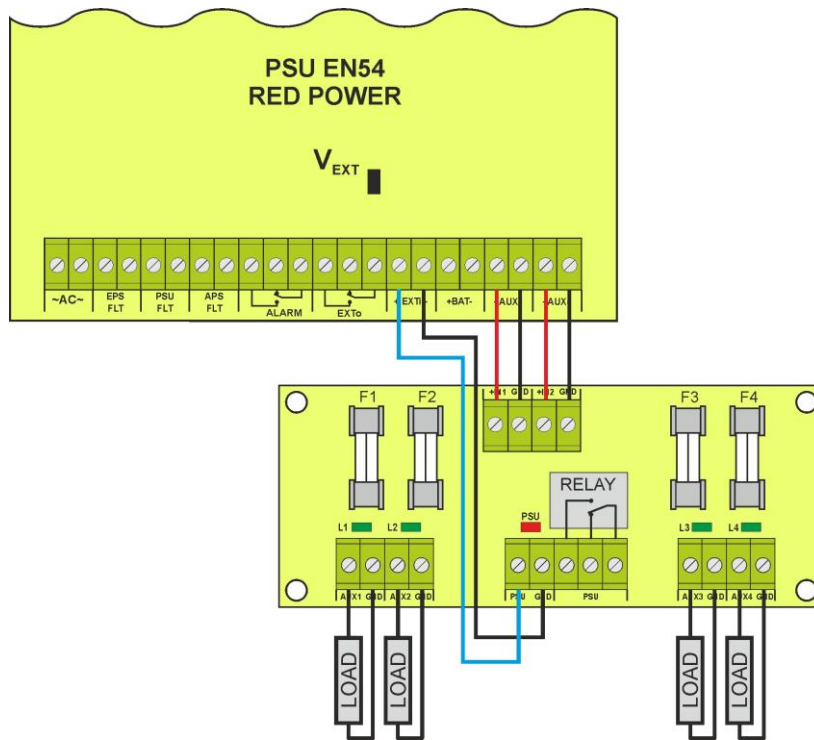

Fig.14. The connection of fuse module.



When installing the fuse module in the PSU, power supply current consumption, used for the calculation of standby time (see section 7.8), should be taken into account.

Depending on the version, fuse module allows to connect 4 or 8 receivers to the PSU. Output state is indicated by green LEDs.

Blown fuse is indicated as follows:

- corresponding LED turns off: L1 for AUX1 etc.
- red LED on
- PSU technical output on (Hi-Z state)
- switching PSU relay output into voltage free status (contacts as shown in the Fig.14).

In addition, blown fuse signal is transmitted to the input of collective failure EXTi (ALARM) and saved in the internal memory of PSU.

The PSU's relay output can also be used for remote control, including external optical indication.

6.8. Overvoltage protection of the PSU output OVP.

In case of voltage exceeding $30,5 \text{ V} \pm 0,5 \text{ V}$ at the switching regulator's output, the system cuts off the power at the outputs to protect the battery and the receivers from damage. The outputs will be battery-powered. The activation of the protection system is indicated by the OVP yellow LED on the PCB board, and the PSU FLT and ALARM outputs.

6.9. PSU overload.

The PSU is fitted with the LED OVL (overload) on the PCB and  indicator on the LED panel, informing about output overload. If the nominal current of the PSU is exceeded, the led turns on and the microprocessor starts a specially implemented procedure. Depending on time and overload level, microprocessor may disconnect the AUX1 and AUX2 outputs and switch into the battery-assisted operation. Restart will occur after 1 minute. PSU overload is indicated by the PSU FLT and ALARM technical outputs.

6.10. Indication of exceeding I_{max} a current.

Exceeding the " I_{max} a" output current during the power supply operation is indicated by the microprocessor using the LED OVL light (overload) on the PCB and LED indicator light  on the LED panel of the power supply after 30 seconds.

Information about exceeding the „ I_{max} a" current is stored in the history of events. Battery charge current is limited in order to protect the power supply against overload.

6.11. Short-circuit of the PSU output.

In case of short-circuit of the AUX1 or AUX2 output, one of the fuses - F_{AUX1} or F_{AUX2} – becomes permanently blown. The restoration of the voltage at the output requires the replacement of the fuse

7. Reserve power supply circuit.

The PSU is fitted with intelligent circuits: battery charging circuit with the function of the accelerated charging and battery control, which main task is to monitor the condition of the batteries and the connections in the circuit.

If the controller detects a power failure in the battery circuit, appropriate indication and activation of the APS FLT and ALARM technical outputs takes place.

7.1. Battery detection.

The control unit of the PSU checks the voltage at the battery terminals and, depending on the measured values, determines the appropriate reaction:

U_{BAT} below 4 V - batteries not connected to the PSU circuits

$U_{BAT} = 4$ to 20 V - faulty batteries

U_{BAT} over 20 V - batteries connected to the PSU circuits

7.2. Protection against short-circuit of the battery terminals.

The PSU is fitted with the circuit protecting against short-circuit of the battery terminals. In case of short circuit, control circuit immediately disconnects the batteries from the rest of the power supply circuit, so the loss of output voltage on power supply outputs is not observed. Automatic reconnection of the batteries to the PSU's circuits is only possible after the removal of the short-circuit and correct connection of the circuits.

7.3. Protection against reverse battery connection.

The PSU is protected against reverse connection of the battery terminals. In case of incorrect connection, the F_{BAT} fuse in the battery circuit becomes blown. The return to normal operation is possible only after replacing the fuse and correct connection of the batteries.

7.4. Deep discharge battery protection UVP.

The PSU is fitted with the disconnection system and the battery discharge indication. If the voltage at the battery terminals drops below $20 V \pm 0.2 V$ during battery-assisted operation, acoustic indication will be activated and the batteries will be disconnected within 15s.

The batteries are reconnected to the power supply unit automatically once the $\sim 230 V$ mains supply is restored.

7.5. Battery test.

The PSU runs battery test every 5 minutes. During testing, the control unit of the PSU measures the electrical parameters according to the implemented measuring method.

A negative result occurs when the battery circuit continuity is interrupted, resistance in the battery circuit increases above 300 m Ω or if the terminal voltage drops below 24 V.

The battery test can be activated manually from the main menu (see section 6.3.1), for example to test the replaced batteries.

The PSU is protected against too frequent performing of the battery test, which could result in undercharging. The protection involves blocking the ability to perform test for 60 seconds from the last activation.

This function can be disabled by putting the Z2 jumper on the power supply board (Fig.2 [8]).

The battery test will also be automatically locked when the PSU is in the operating mode, in which the battery test is impossible. Such condition occurs, for example, during battery assisted operation or when the power supply is overloaded.

7.6. Measurement of the resistance of the battery circuit.

The PSU is checking the resistance in the battery circuit. During the measurement, the PSU driver takes into account the key parameters in the circuit, and once the limit value of 300m ohms is exceeded, a failure is indicated.

A failure may indicate considerable wear or loose cables connecting the batteries.

7.7. Battery temperature measurement.

The PSU has a temperature sensor to monitor the temperature parameters of installed batteries. The sensor is located near the batteries; hence, temperature readings should not be confused with the ambient temperature.

Temperature measurement and compensation of the battery charging voltage can extend the life of the batteries.

7.8. Standby time.

Battery-assisted operating depends on battery capacity, charging level and load current. To maintain an appropriate standby time, current drawn from the PSU in battery mode should be limited.

Required, minimum battery capacity to work with the PSU can be calculated with the following formula:

$$Q_{AKU} = 1.25 \left((I_d + I_z) \cdot T_d + (I_a + I_z) \cdot T_a + 0.05 I_c \right)$$

where:

- Q_{AKU} – The minimum battery capacity [Ah]
- 1.25 – the factor related to the decrease in battery capacity due to aging
- I_d – the current drawn by the load during inspection [A]
- I_z – PSU current consumption [A]
- T_d – required inspection time [h]
- I_a – the current drawn by the load during an alarm [A]
- T_a – alarm duration [h]
- I_c – short-term output current

Rearranging the above equation, the approximate runtime of the system with two 28 Ah batteries can be determined.

The following data can be assumed:

$$\begin{aligned} I_d &= 1 \text{ A} \\ I_z &= 0,078 \text{ A} \\ I_a &= 3 \text{ A} \\ T_a &= 0,5 \text{ h} \\ I_c &= 5 \text{ A} \end{aligned}$$

The approximate runtime of the system with two 28 Ah batteries will amount to 13h 3min.

8. Remote monitoring (options: Wi-Fi, Ethernet, RS485, USB).

The PSU has been adjusted to operate in a system that requires a remote control of the parameters in a monitoring centre. Transmitting data concerning PSU status is possible due to an additional, external communication module responsible for communication in Wi-Fi, Ethernet or RS485 standard. The USB –TTL interface enables the connection between the PSU and the computer.

Different connection topologies, presented later in this chapter, are only a part of possible communication schemes. More examples can be found in the manuals dedicated to individual interfaces.



When installing optional features in the power supply unit, power supply current consumption, used for the calculation of standby time, should be taken into account (see section 7.8.).

8.1. Communication via the USB-TTL interface.

The easiest way of communication between the PSU and the computer is provided by the USB-TTL "INTU" interface. This interface allows direct connection between the computer and the PSU and is recognizable by the operating system as a virtual COM port.

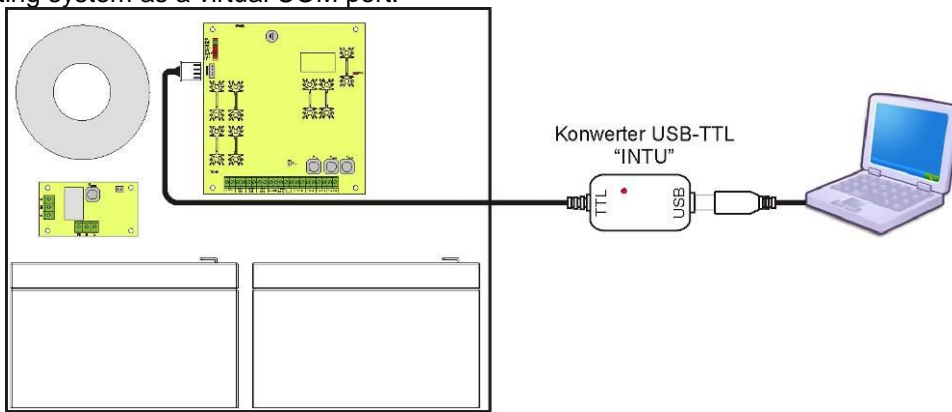

Fig. 15. USB-TTL communication using the USB-TTL „INTU” interface.

8.2. ETHERNET network communication.

Communication in the Ethernet network is possible due to the additional interfaces: Ethernet „INTE” and RS485-ETH „INTRE”, according to the IEEE802.3 standard.

The Ethernet „INTE” interface features full galvanic isolation and protection against surges. It should be mounted inside the enclosure of the PSU.

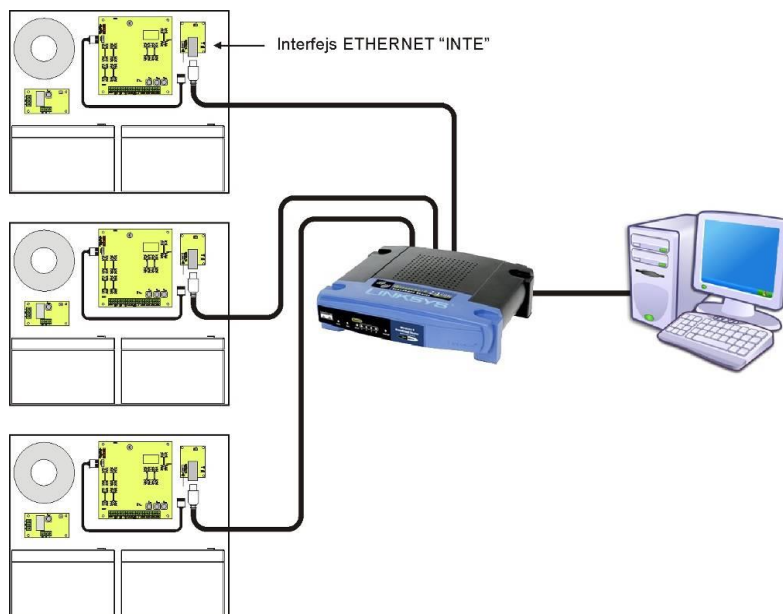

Fig. 16. Ethernet network communication using the Ethernet „INTE” interface.

The RS485-WiFi „INTRE” interface is a device used to convert signals between the RS485 bus and the Wi-Fi network. For proper operation, the unit requires an external power supply in the range of 10÷30 V DC e.g. drawn from a PSU of the EN54 series. The unit is mounted in a hermetic enclosure protecting against adverse environmental conditions.

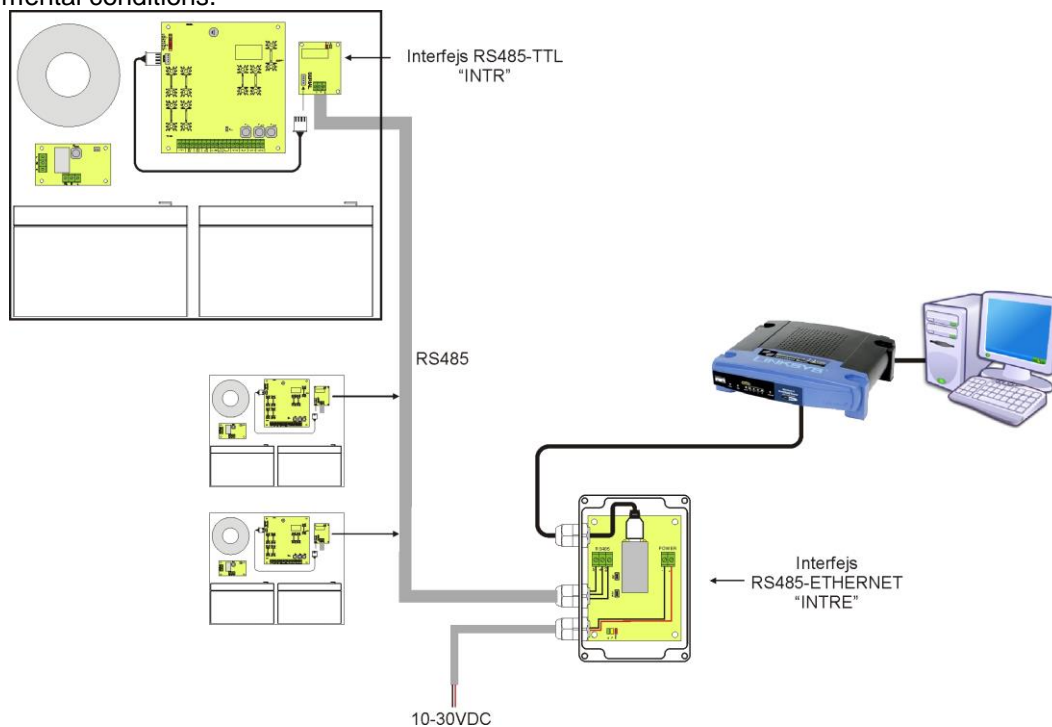

Fig. 17. Ethernet network communication using the RS485 „INTRE” interface.

8.3. The Wi-Fi wireless communication.

The Wi-Fi wireless communication can be implemented on the basis of additional interfaces: WI-FI 'INTW' and RS485-WiFi, operating within 2,4GHz frequency band, according to the IEEE 802.11 bgn standard.

The WiFi "INTW" interface shall be mounted in a selected location inside the enclosure so that the antenna is exposed to the outside.

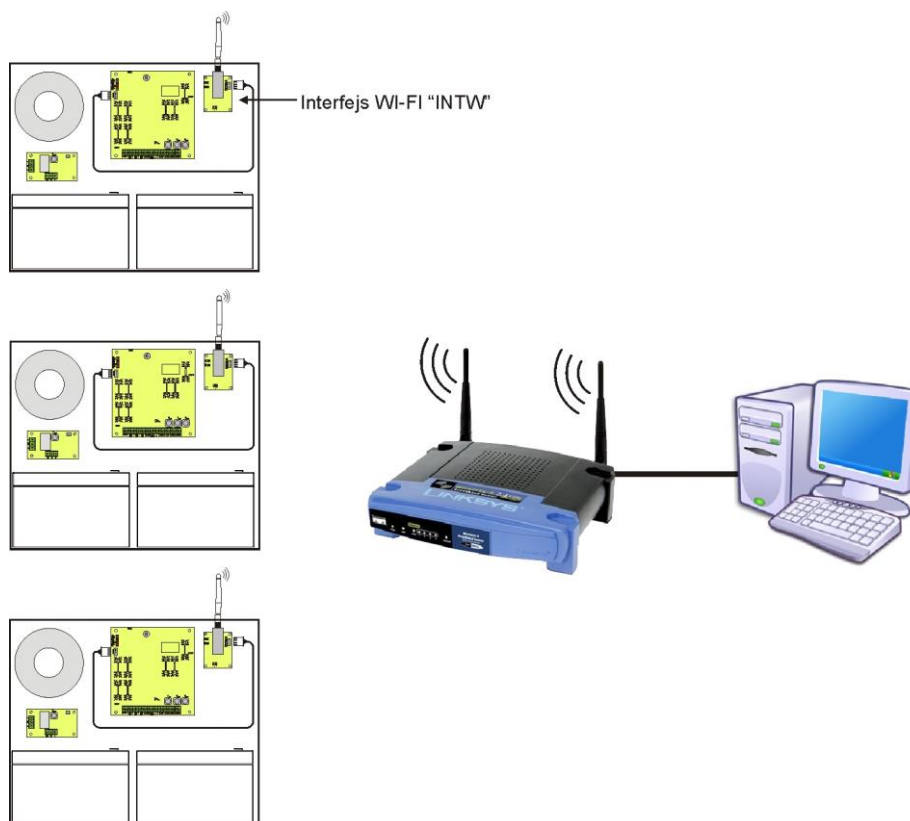

Fig. 18. The Wi-Fi communication using WI-FI „INTW” interface.

The RS485-WiFi „INTRW” interface is a device used to convert signals between the RS485 bus and the WiFi network. For proper operation, the unit requires an external power supply in the range of 10÷30 V DC e.g. drawn from a PSU of the EN54 series. The physical connection of the interface takes place under galvanic isolation. The unit is mounted in a hermetic enclosure protecting against adverse environmental conditions.

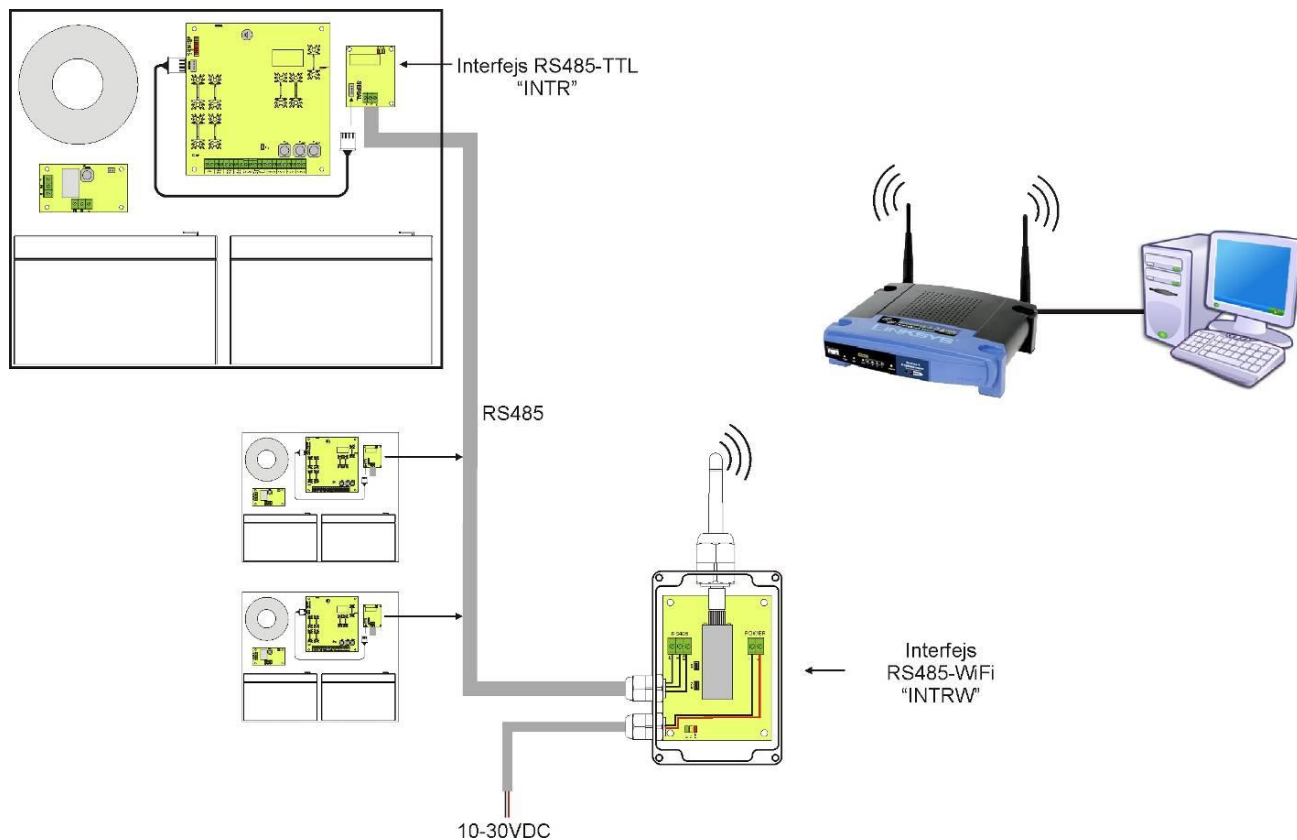

Fig. 19. The Wi-Fi communication using the RS485-WIFI „INTRW” interface.

8.4. RS485 network communication.

Another type of network communication is the RS485 communication using two-wire transmission path. To achieve this kind of data exchange, the PSU should be equipped with the additional RS485 TTL "INTR" interface, converting data from the PSU into the RS485 standard and the USB-RS485 "INTUR" interface, converting data from the RS485 network to the USB. Offered interfaces are galvanically isolated and protected against surges.

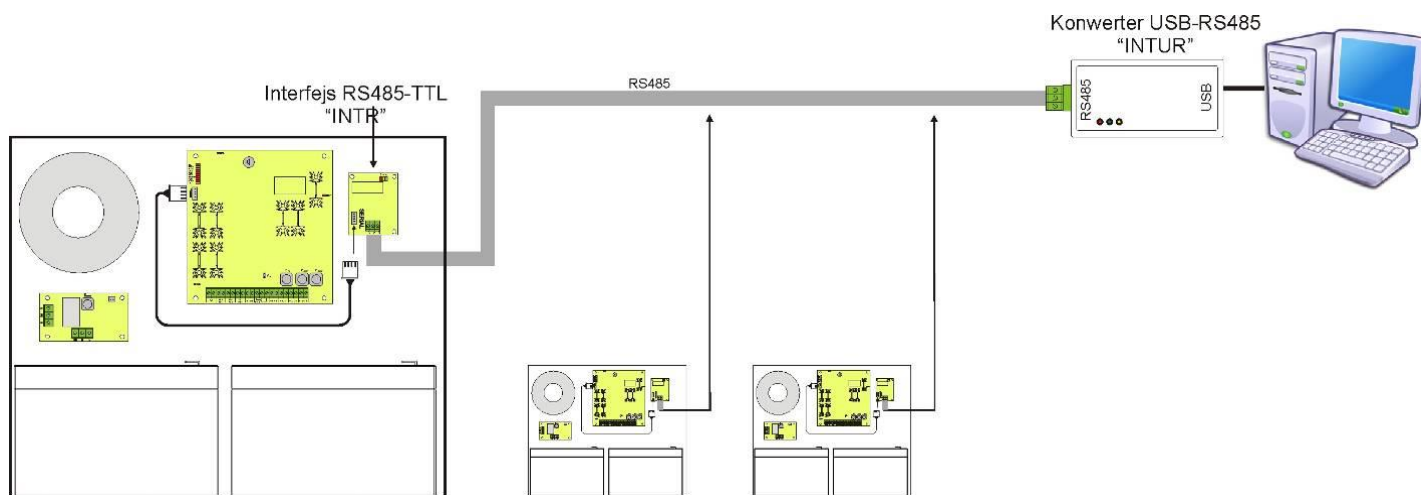

Fig. 20. RS485 communication using the „INTR” and „INTUR” interfaces.

8.5. „PowerSecurity” program.

The "Power Security" program is available on www.pulsar.pl
Its detailed description can be found in the manual.

PowerSecurity is a program designed to operate with power supplies of the PSBEN, EN54 and EN54C/LCD series.

The graphical interface of the program has been designed so that it is convenient to combine power supplies into groups giving the possibility of monitoring multiple parameters in one window simultaneously. The program constantly monitors the parameters of all power supplies; in case of failures the backlight changes accordingly in both the manager window and the Windows taskbar. In addition, the program allows you to download the operation history of the power supply, the history of events, and visualization in the form of charts and tables. The downloaded data can be saved.

The program also provides functionality in the form of a remote battery test. The result of the battery test takes the form of a message.

The PowerSecurity software is a free software. Operation requires a PC with the operating system Windows 10 or older.

The application can also be used by people who install and service power supplies. The main panel of the program is shown below.

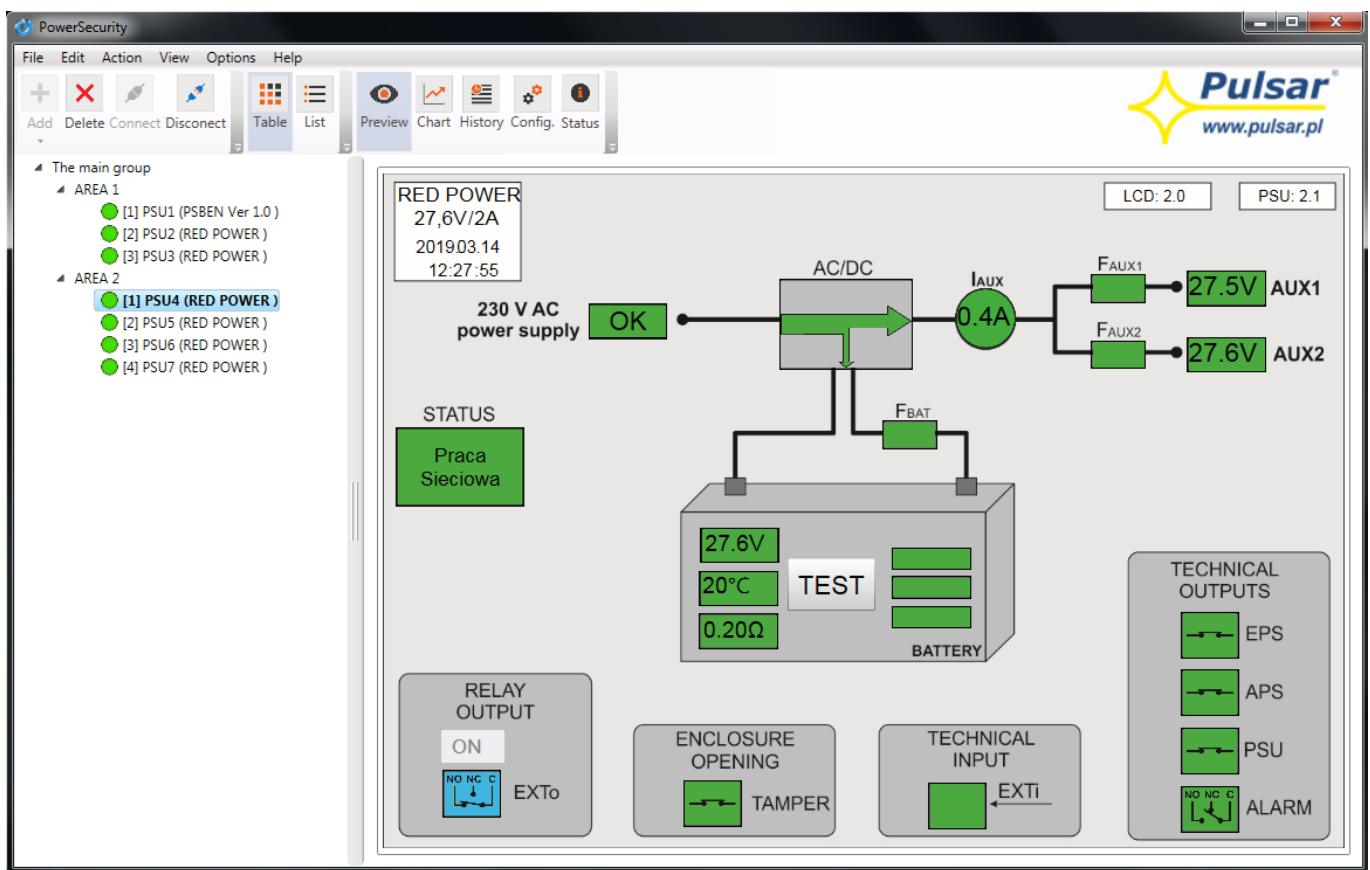

Fig. 21. The main panel of the "Power security" program.

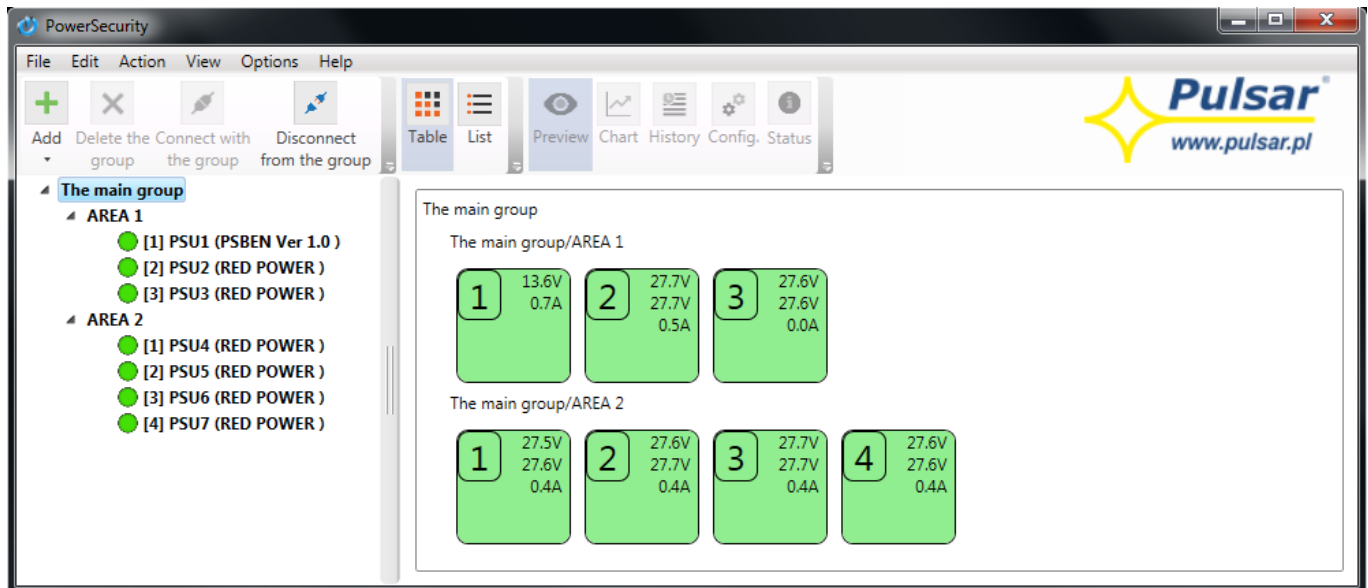

Fig. 22. The main panel of the "Power security" program - the "Synoptic board" tab.

The manager window allows you to combine monitored power supplies into groups / subgroups offering greater control and transparency for more complex systems.

The device window can be switched between two modes: the synoptic board or the list mode. This is especially useful when the PowerSecurity program works with a large number of power supplies.

The application enables both visualization and analysis of read data. Exceeding the permissible parameters is signaled by a change in color of the relevant field to yellow and a flashing indicator light. It is possible to view the current power supply parameters, historical parameters in the chart, electrical parameters, the status of technical outputs, and to read the event log on individual tabs.

9. Technical parameters.

Electrical parameters (Table 12).

Mechanical parameters (Table 13).

Safety of use (Table 14).

Recommended types and sections of installation cables (Table 15)

Table 12. Electrical parameters.

Functional class EN 12101-10:2007	A
Mains supply	~230 V
Current consumption	0,95 A
Power frequency	50 Hz
PSU's power	138 W
Efficiency	84%
Output voltage at 20 °C	22,0 V ÷ 27,6 V DC – buffer operation 20,0 V ÷ 27,6 V DC – battery-assisted operation
Output current	Continuous operation Output current I_{max a}=3,5 A Instantaneous operation Output current I_{max b}=5 A
Maximal resistance of the battery circuit	300mΩ
Ripple voltage	90mV p-p max.
Current consumption by the PSU during battery-assisted operation	I = 78mA Caution ! If the power supply is connected with the communication interface or fuse module, additional current consumption should be considered.
Battery charging current	1,5 A
Coefficient of temperature compensation of the battery voltage	-40mV/ °C (-5 °C ÷ 40 °C)
Low battery voltage indication	U _{bat} < 23 V, during battery mode
Overvoltage protection OVP	U > 30,5 V, disconnection of the output voltage (AUX+ disconnection), automatic return
Short-circuit protection SCP	F6,3 A – current limit, F _{AUX} melting fuse (failure requires fuse replacement)
Overload protection OLP	Hardware - Software
Battery circuit protection SCP and reverse polarity connection	F10 A- current limit, F _{BAT} melting fuse (failure requires fuse replacement)
Deep discharge battery protection UVP	U < 20 V (± 2%) – disconnection (+BAT) of the batteries,
TAMPER output indicating enclosure opening	Microswitch TAMPER
Technical outputs: - EPS FLT; indicating AC power failure	- type – electronic, max 50mA/30 V DC, galvanic isolation 1500 V _{RMS} - delay time approximately 10s/1m/10m/30m (+/-5 %) – configured from the LED panel
- APS FLT; indicating battery failure - PSU FLT; indicating PSU failure - ALARM; indicating collective failure	- type – electronic, max 50mA/30 V DC, galvanic isolation 1500 V _{RMS} - type – relay: 1 A @ 30 V DC/50 V AC CAUTION! In Fig.2 the set of contacts shows a potential-free status of the relay, which corresponds to power supply failure.
EXTi technical input	Voltage „ON” – 10÷30 V DC Voltage „OFF” – 0÷2 V DC Level of galvanic isolation 1500 V _{RMS}
EXTo relay output	1 A @ 30 V DC /50 V AC
Optical indication:	- LEDs on the PCB of the power supply unit, - LED panel <ul style="list-style-type: none"> • output current readings • output voltage readings: AUX1, AUX2 • resistance of the battery circuit • mains supply voltage • failure codes and history
Acoustic indication:	- piezoelectric indicator ~75 dB /0,3 m, switched from the LED panel
Fuses: - F _{MAINS} - F _{BAT} - F _{AUX1}	T 6,3 A / 250 V F 10 A / 250 V F 6,3 A / 250 V

- F _{AUX2}	F 6,3 A / 250 V
Additional equipment (not included)	<ul style="list-style-type: none"> - USB-TTL „INTU” interface; USB-TTL communication - RS485 „INTR” interface; RS485 communication - USB-RS485 „INTUR” interface; USB-RS485 communication - Ethernet „INTE” interface; Ethernet communication - WiFi “INTW” interface; WiFi wireless communication - RS485-Ethernet “INTRE” interface; RS485-Ethernet communication - RS485-WiFi “INTRW” interface; RS485-WiFi wireless communication

Table 13. Mechanical parameters.

Enclosure dimensions	W=420 H=420 D+D ₁ =182 + 8 [+/- 2mm] W ₁ =425 H ₁ =425 [+/- 2mm]
Mounting	380 x 345 x Φ 6 x4 pieces (WxH)
Recommended battery model	- 2 x EP 28-12 or - 2 x GP12260
Fitting battery	2x28 Ah/12 V (SLA) max. 400 x 180 x 175mm (WxHxD) max
Net/gross weight	11,1/12,6 kg
Enclosure	Steel plate DC01 1,2mm, color: RAL 3001 (red)
Closing	Key lock
Terminals	Mains supply: Φ0,51±2 (AWG 24-12) Outputs: Φ0,51±2 (AWG 24-12) Battery outputs BAT: Φ6 (M6-0-2,5)
Cable glands	PG9 – cable diameter Φ4÷8mm PG11 – cable diameter Φ5÷10mm
Notes	The enclosure does not adjoin the mounting surface so that cables can be led. Convection cooling.

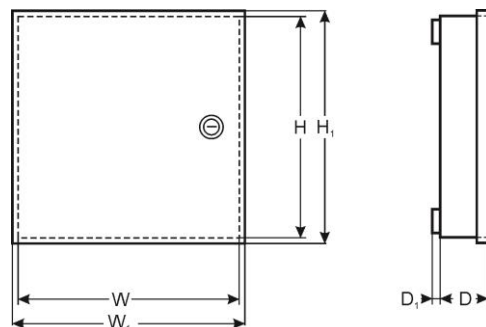
**Table 14. Safety of use.**

Protection class EN 60950-1:2007	I (first)
Protection grade EN 60529: 2003	IP42
Insulation electrical strength: - between input (network) circuit and the output circuits of the PSU - between input circuit and protection circuit - between output circuit and protection circuit	3000 V AC min. 1500 V AC min. 500 V AC min.
Insulation resistance: - between input circuit and output or protection circuit	100 MΩ, 500 V DC

Table 15. Recommended types and sections of installation cables.

Mains supply ~230 V L-N-PE (see Table 2 [2])	OMY 3 x 0,75 mm ² ...1,5 mm ²
AUX1, AUX2 output terminals (see Table 1 [11])	HLGs 2 x 1,5 mm ² ...2,5 mm ²
Indication inputs/outputs (see Table 1 [11])	YnTKSY 1 x 2 x 0,8 mm ²
Additional indication lines (with optional interface)	FTP 4x2x0,5 cat. 5e

10. Technical inspections and maintenance.

Technical inspections and maintenance can be performed after disconnecting the power supply from the power network. The PSU does not require any specific maintenance, however, its interior should be cleaned with compressed air if it is used in dusty conditions. In case of fuse replacement, use only compatible replacement parts.

Technical inspections should be carried out not less frequently than once per year. During the inspection, check the batteries and run the battery test.

4 weeks after installation, re-tighten all threaded connections, see Fig. 2 [11] and Fig. 3 [2].



CAUTION!

According to the recommendations of the CNBOP and VdS institutes, the batteries should be replaced after four years of service, regardless of their status.

**WEEE MARK**

According to the EU WEE Directive – It is required not to dispose of electric or electronic waste as unsorted municipal waste and to collect such WEEE separately.



CAUTION! The power supply unit is adapted for cooperation with the sealed lead-acid batteries (SLA). After the operation period they must not be thrown but recycled according to the applicable law

Pulsar sp.j.

Siedlec 150, 32-744 Łapczyca, Polska
Tel. (+48) 14-610-19-40, Fax. (+48) 14-610-19-50
e-mail: biuro@pulsar.pl, sales@pulsar.pl
http:// www.pulsar.pl, www.zasilacze.pl