

# DT-QSW

Camera Interface

## User Manual

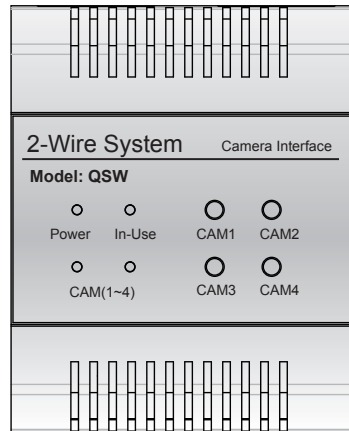

Please read this manual carefully before using the product you purchase, and keep it well for future use. We reserve the right to modify the specification in this manual at any time without notice.

# 1.About DT-QSW Unit

---

Discription:

The DT-QSW module is designed to DT system for the purpose of video quad splitter, four images from 4 different cameras can be displayed on screen of monitor via QSW unit.

NOTE: For monitor which support split display function, it can use the split display function of DT-QSW.

## 2. Terminal Description

---

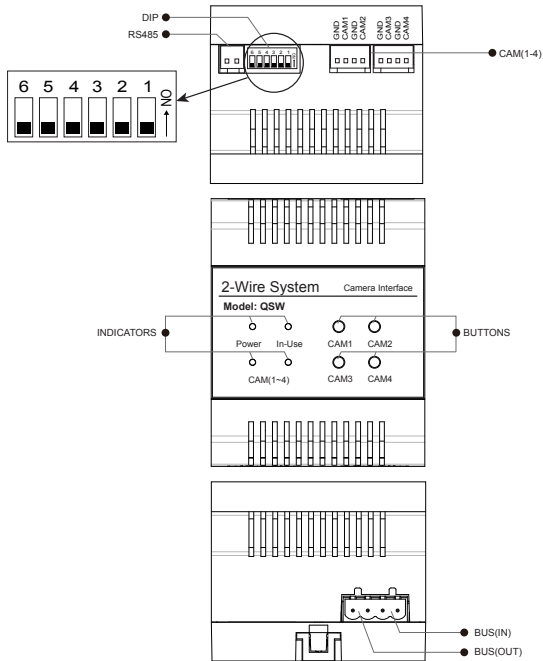

RS485:Reserved.

CAM1-4:Connect to regular analog CCTV.

BUS(IN):Connect to the bus line, no polarity.

BUS(OUT):Connect to the bus line, no polarity.

INDICATORS:

- 1.Power: Working indicator, always on when the QSW work normally.
- 2.In-Use:Video output indicator, always on when the QSW output the video.
- 3.CAM(1~4):Video output indicator.

In-Use	CAM(1~4)		Description
●	○	○	CAM1 video output
●	●	○	CAM2 video output
●	○	●	CAM3 video output
●	●	●	CAM4 video output









\* NOTE:

- A. ● :It shows that the indicator ON;  
○ :It shows that the indicator OFF.
- B. CAM(1~4) indicator always on when CAM4 video output;  
CAM(1~4) indicator flash when video split output video.

BUTTONS:

- 1.Press CAM1 button in monitoring state, the system will mandatory output the video of CAMERA 1.
- 2.Press CAM2 button in monitoring state, the system will mandatory output the video of CAMERA 2.
- 3.Press CAM3 button in monitoring state, the system will mandatory output the video of CAMERA 3.
- 4.Press CAM4 button in monitoring state, the system will mandatory output the video of CAMERA 4.
- 5.Press and hold CAM4 button for 3 seconds in monitoring state, the system will mandatory output the video of quad split.

## DIP:DIP switches.

Bit	Bit State	Description
DIP1~DIP2		set to the first DT-QSW.
		set to the second DT-QSW.
		set to the third DT-QSW.
		set to the fourth DT-QSW.
DIP3		When set to OFF, it means that the third and fourth cameras unavailable; When set to ON, it means that the third camera available.
DIP4		When set to OFF, it means that the fourth camera unavailable; When set to ON, it means that the fourth camera available.
DIP5		When set to OFF, it means that the system select video split display mode A, for details, see later section #; When set to ON, it means that the system select video split display mode B, for details, see later section #.
DIP6		When the system connected SC6V, and SC6V connected two cameras(the two cameras of the device is valid),it should be set to ON; When the system don't connected SC6V(or connected SC6V, but SC6V don't connected camera), it should be set to OFF.

## # NOTE:

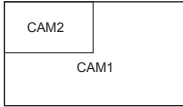
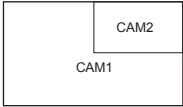
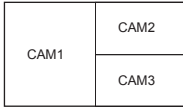
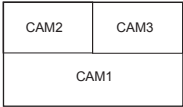
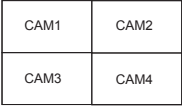
	Mode A	Mode B
Two cameras:		
Three cameras:		
Four cameras:		

### 3. Unit Mounting

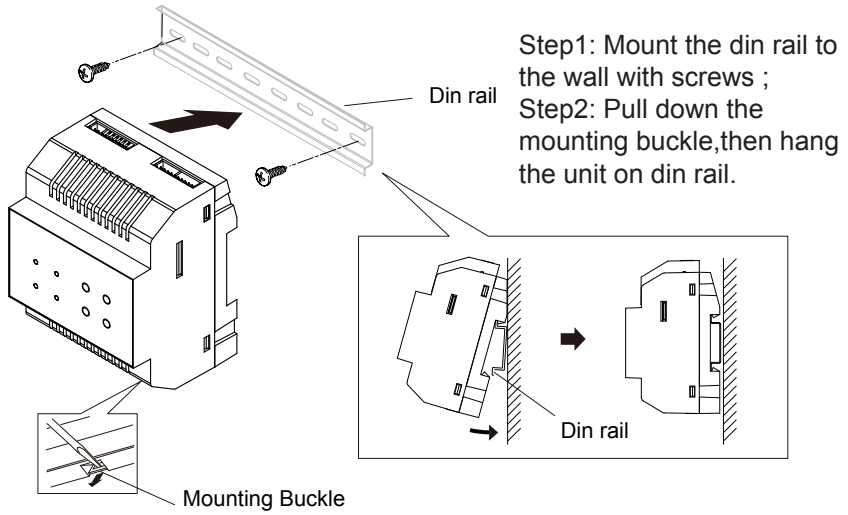



## 4.2 Multi door station and two QSW applications:

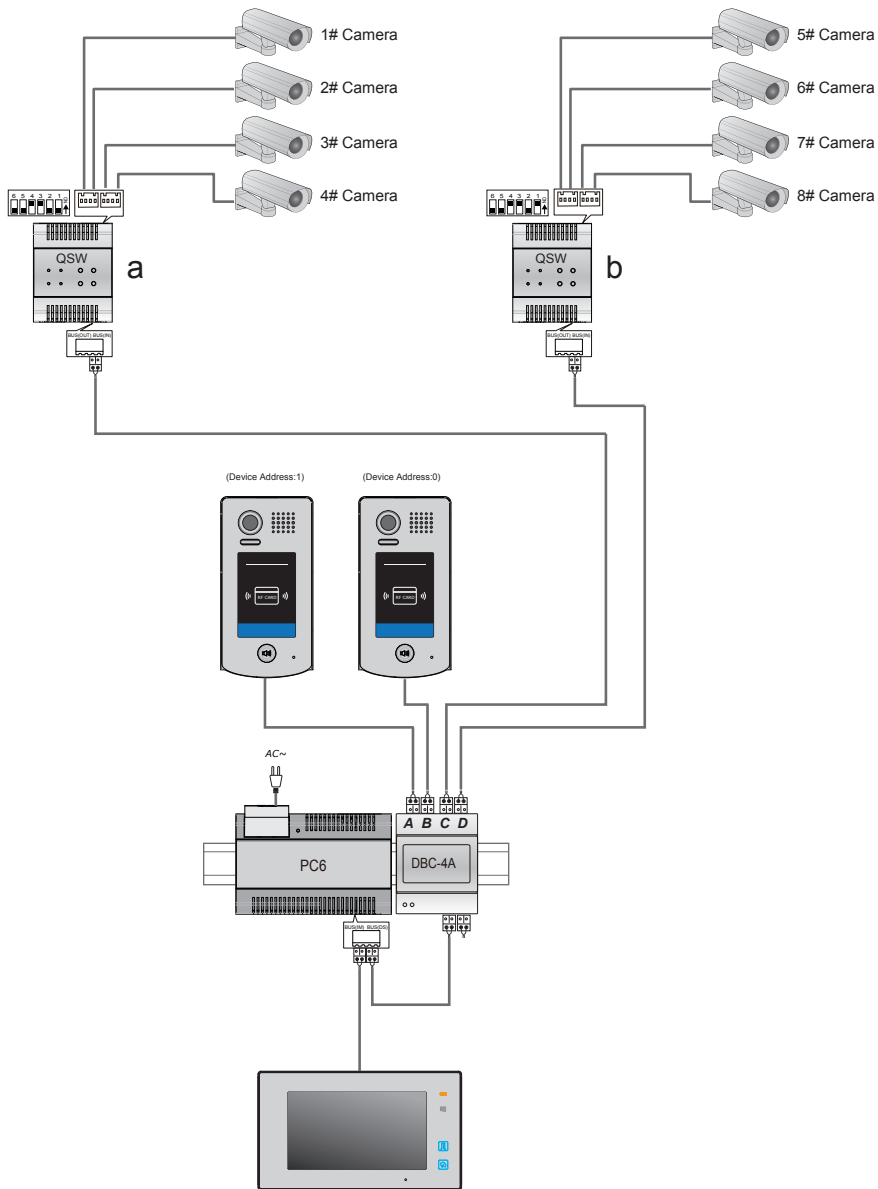

NOTE: The system can connect SC6V, but at this time, the DIP6 of DT-QSW must be set to ON.

## 5. Specification

- Power Supply : DC24V;
- Working Temperature:  $-15^{\circ}\text{C}\sim+55^{\circ}\text{C}$ ;
- Wiring: 2 wire, non-polarity;
- Dimension: 90(H) $\times$ 72(W) $\times$ 60(D)mm.

The design and specifications can be changed without notice to the user. Right to interpret and copyright of this manual are preserved.