



Synology Network Video Recorder DVA1622

Hardware Installation Guide

Table of Contents

Chapter 1: Before You Start

| | |
|--------------------------------------|----|
| Package Contents..... | 3 |
| Synology DVA1622 at a Glance..... | 4 |
| System Modes and LED Indicators..... | 5 |
| Other LED Indicators..... | 7 |
| Hardware Specification..... | 8 |
| Spare Parts..... | 9 |
| Optional Accessories..... | 9 |
| Safety Instructions..... | 10 |

Chapter 2: Hardware Setup

| | |
|---|----|
| Tools and Parts for Component Installation..... | 11 |
| Install Drives..... | 11 |
| Start up Your Network Video Recorder..... | 12 |

Chapter 3: Install DSM on Network Video Recorder





| | |
|------------------|----|
| Install DSM..... | 14 |
| Learn More..... | 15 |

Before You Start

Thank you for purchasing this Synology product! Before setting up your new Network Video Recorder, please check the package contents to verify that you have received the items below. Also, make sure to read the safety instructions carefully to avoid harming yourself or damaging your Network Video Recorder.

Note: All images below are for illustrative purposes only, and may differ from the actual product.

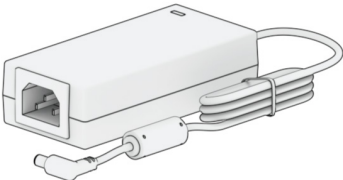
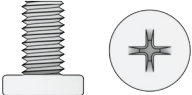
Package Contents

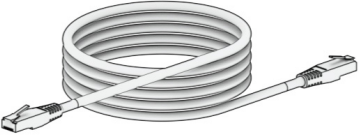
| | | |
|---|---|---|
| Main unit x 1 | | AC power cord x 1 |
|  | |  |
| | | AC Power Adapter x 1 |
| | |  |
| Screws for 2.5" drives x 10 | Drive tray key x 2 | RJ-45 LAN Cable x 1 |
|  |  |  |

Synology DVA1622 at a Glance

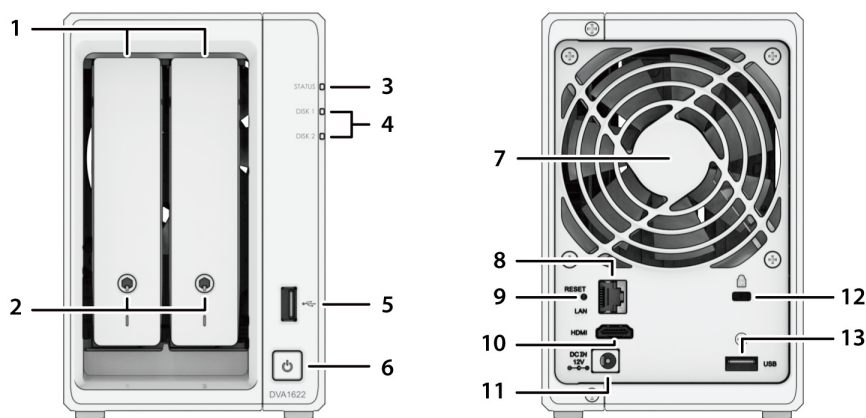

| No. | Article Name | Location | Description |
|-----|--------------------------|----------|--|
| 1 | Drive Tray | Front | Install drives (hard disk drives or solid state drives) here. |
| 2 | Drive Tray Lock | | Lock or unlock drive trays. |
| 3 | STATUS Indicator | | Displays the status of the system. For more information, see "System Modes and LED Indicators". |
| 4 | DRIVE Status Indicator | | Displays the status of each drive. For more information, see "Other LED Indicators". |
| 5 | USB 3.2 Gen 1 Port | | Connect external drives or other USB devices to the Network Video Recorder here. |
| 6 | Power Button | | <ol style="list-style-type: none"> 1. Press to power on your Network Video Recorder. 2. To power off your Network Video Recorder, press and hold until you hear a beep sound and the Power LED starts blinking. |
| 7 | Fan | Back | Disposes of excess heat and cools the system. If the fan malfunctions, the Network Video Recorder will emit a beeping sound. |
| 8 | 1GbE RJ-45 Port | | Connect RJ-45 network cable here. |
| 9 | Reset Button | | <ol style="list-style-type: none"> 1. Mode 1: Press and hold until you hear a beep sound to restore the IP address, DNS server, and password for the admin account to default. 2. Mode 2: Press and hold until you hear a beep, release the button immediately, then press and hold again until you hear three beeps to return the Network Video Recorder to "Not Installed" status so that DiskStation Manager (DSM) can be reinstalled. <p>For detailed information on how to reset your Network Video Recorder, please refer to this article.</p> |
| 10 | HDMI Output | | Connect HDMI cable here. |
| 11 | Power Port | | Connect power cord here. |
| 12 | Kensington Security Slot | | Attach a Kensington security lock here. |
| 13 | USB 3.2 Gen 1 Port | | Connect external drives or other USB devices to the Network Video Recorder here. |

System Modes and LED Indicators

System Modes and Definitions

There are 7 system modes in Network Video Recorder. The system modes and their definitions are as below:

| System mode | Definition |
|----------------------|---|
| Powering on | Network Video Recorder is powering on when you press the power button or restarting when you run operations in DSM. During the boot up process, the device also performs hardware initialization, such as hardware reset or BIOS initialization. |
| Shutting down | Network Video Recorder is shutting down when you press the power button or run operations in DSM. |
| DSM not ready | DSM is not ready for use. This could either be: <ul style="list-style-type: none"> • Network Video Recorder is powered on, but DSM is not properly installed. • Network Video Recorder is currently powering on and initializing services necessary for DSM to fully function. • The attached UPS device has insufficient power; DSM stops all services to prevent data loss (enters safe mode). |
| DSM is ready for use | DSM is fully functioning and users can sign in. |
| Hibernation | Network Video Recorder has been idle for a while and is now in Hibernation mode. |
| Application | Certain packages/services (e.g., USB Copy and Find me service) while in operation will control the actions of the LED. After the operation is complete, the LED indicator will return to its normal state. |
| Powered off | Network Video Recorder is powered off. |

Identify System Modes

You can identify the system mode through the POWER and STATUS LED indicators. Please refer to below table for more details.

| System mode | LED Indicator | | |
|----------------------|---------------|-----------|--------|
| | POWER | STATUS | |
| | Green | Green | Orange |
| Powering on | Blinking | Off | Off |
| Shutting down | Blinking | Static | Off |
| DSM not ready | Static | Blinking | Off |
| DSM is ready for use | Static | Static | Off |
| Hibernation | Static | Off | Off |
| Application | Static | Switching | |
| Powered off | Off | Off | Off |

Note: If the STATUS LED remains static orange or continuously blinks orange, this indicates there are system errors such as fan failure, system overheating, or volume degrade. Please sign in to DSM for detailed information.

Transitions between System Modes

To better understand the transition between system modes, please refer to below examples:

- **Powered on with no DSM installed:**

Powered off > Powering on > DSM not ready

- **Powered on with DSM installed:**

Powered off > Powering on > DSM not ready > DSM is ready for use

- **Enter hibernation then wake up from hibernation:**

DSM is ready for use > Hibernation > DSM is ready for use

- **Shutdown Network Video Recorder:**

DSM is ready for use > Shutting down > Powered off

- **Power failure with UPS attached:**

DSM is ready for use > DSM not ready (due to power failure, DSM enters safe mode) > Shutting down > Powered off > Powering on (power has recovered, DSM will reboot) > DSM not ready > DSM is ready for use

Other LED Indicators

| LED Indicator | Color | Status | Description |
|--|---------------------|-------------------|---|
| DRIVE status | Green | Static | Drive ready and idle |
| | | Blinking | Accessing drive |
| | Orange ¹ | Static | Locating drive |
| | | | Drive deactivated by user |
| | | | Port disabled ² |
| | | | Removing this drive will cause system damage; this is the only drive with DSM installed |
| Off | | No internal Drive | |
| Rear 1GbE LAN (on lower side of jack) | Green | Static | 1 Gbps connected |
| | Orange | | 100 Mbps connected |
| | Off | | 10 Mbps connected/No network |
| Rear 1GbE LAN (on upper side of jack) | Green | Static | Network connected |
| | | Blinking | Network active |
| | Off | | No network |

Note:

- 1 When the drive LED indicator is red/orange, we recommend you sign in to DSM and go to **Storage Manager > HDD/SSD** for more information.
- 2 Please try to restart your Network Video Recorder or re-insert the drives, then run the HDD/SSD manufacturer's diagnostic tool to check the health status of the drives. If you can sign in to DSM, please run the built-in S.M.A.R.T. test to scan the drives. If the problem remains unresolved, please contact Synology Technical Support for help.

Hardware Specification

| Item | DVA1622 |
|-------------------------|--|
| Compatible Drive Type | 2.5"/3.5" SATA x 2 |
| External Port | <ul style="list-style-type: none"> • USB 3.2 Gen 1 x 2 • HDMI Output x 1 |
| LAN Port | 1GbE RJ-45 x 1 |
| Size (H x W x D) (mm) | 166 x 106 x 223 |
| Weight (kg) | 1.51 |
| Supported Client | <ul style="list-style-type: none"> • Windows 7 onwards • macOS 10.12 onwards |
| File System | <ul style="list-style-type: none"> • Internal: Btrfs, ext4 • External: Btrfs, ext4, ext3, FAT32, NTFS, HFS+, exFAT¹ |
| Supported RAID Type | <ul style="list-style-type: none"> • Basic • JBOD • RAID 0 • RAID 1 • Synology Hybrid RAID (1-Disk Fault Tolerance) |
| Agency Certification | <ul style="list-style-type: none"> • FCC Class B • CE Class B • UKCA • BSMI Class B • EAC • VCCI • RCM • KC • RoHS Compliant |
| HDD Hibernation | Yes |
| Scheduled Power On/Off | Yes |
| Wake on LAN | Yes |
| Language Localization | <ul style="list-style-type: none"> • English • Deutsch • Français • Italiano • Español • Dansk • Norsk • Svensk • Nederlands • Русский • Polski • Magyar • Português do Brasil • Português Europeu • Türkçe • Český • 日本語 • 한국어 • ไทย • 繁體中文 • 简体中文 |
| Environment Requirement | <ul style="list-style-type: none"> • Line voltage: 100 V to 240 V AC • Frequency: 50/60 Hz • Operating Temperature: 32 to 104°F (0 to 40°C) • Storage Temperature: -5 to 140°F (-20 to 60°C) • Relative Humidity: 5% to 95% RH |

Note: Model specifications are subject to change without notice. Please refer to www.synology.com for the latest information.

¹ Support for exFAT can be enabled by purchasing and downloading exFAT Access in Package Center.

Spare Parts



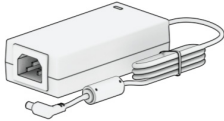



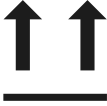

Visit www.synology.com/products/spare_parts if you need to replace system fans, disk trays, or power supply units

| Model Name | Picture | Description |
|---------------------|---|--------------------------------|
| Disk Tray (Type D9) | " data-bbox="421 191 576 234"/> | 3.5"/2.5" Drive Tray With Lock |
| FAN 92*92*25_1 |  | System Fan 92*92*25 mm |
| Adapter 60W_1 |  | Adapter 60W Level VI |

Optional Accessories

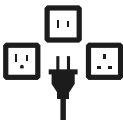
With Synology accessories, you can customize your Network Video Recorder to fit different business environments without worrying about compatibility and stability. Visit www.synology.com/compatibility for more information.

Safety Instructions

| | |
|---|--|
|  | <p>Keep away from direct sunlight and away from chemicals. Ensure a stable environment with no abrupt changes in temperature or humidity.</p> |
|  | <p>Place the unit right side up at all times.</p> |
|  | <p>Keep the unit away from liquids.</p> |
|  | <p>Before cleaning, unplug the power cord. Do not use chemical or aerosol cleaners. Wipe with damp paper towels.</p> |
|  | <p>To prevent the unit from falling over, do not place it on carts or any unstable surfaces.</p> |
|  | <p>The power cord must plug into the correct supply voltage. Ensure the supplied AC voltage is correct and stable.</p> |
|  | <p>Warning, electric shock hazard. To remove all electrical current from the device, ensure that all power cords are disconnected from the power source.</p> |
|  | <p>Risk of explosion if the battery is replaced by an incorrect type. Dispose of used batteries appropriately.</p> |
|  | <p>Power cord must be plugged into a socket-outlet with earthing connection.</p> |
|  | <p>Keep body parts away from moving fan.</p> |

Hardware Setup

Tools and Parts for Component Installation

Please prepare below tools and parts before setting up your Network Video Recorder:

- A screwdriver (only for 2.5" drives)
- At least one 3.5" or 2.5" SATA drive (please visit www.synology.com/compatibility for compatible drive models)

Warning: If you install a drive that contains data, the system will format the drive and erase all existing data. Please back up any important data before installation.

Install Drives

- 1 To remove the drive tray, pull the lower part of the drive tray handle in the indicated direction as shown in the image below. Then pull out the drive tray.

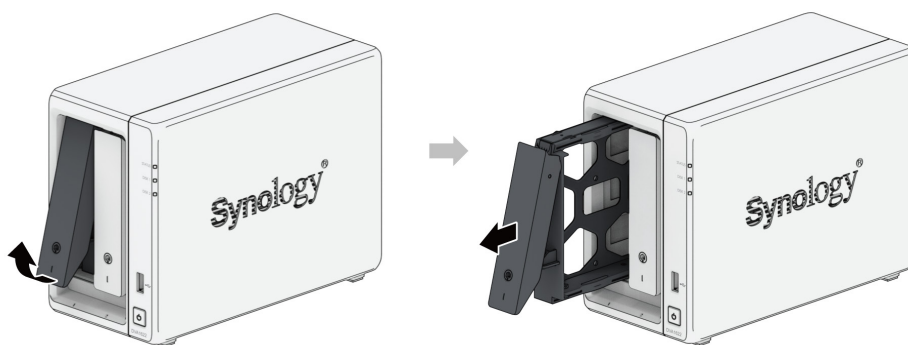

- 2 Install drives:

- **For 3.5" drives:** Remove the fastening panels from the sides of the drive tray. Place the drive in the drive tray. Then insert the fastening panels to secure the drive in place.

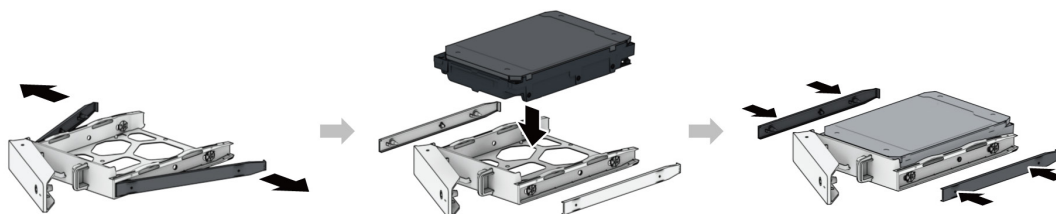

- **For 2.5" drives:** Remove the fastening panels from the sides of the drive tray and store them in a safe place. Place the drive in the area of the drive tray indicated by a blue rectangle below. Turn the tray upside down and tighten the screws to secure the drive in place.

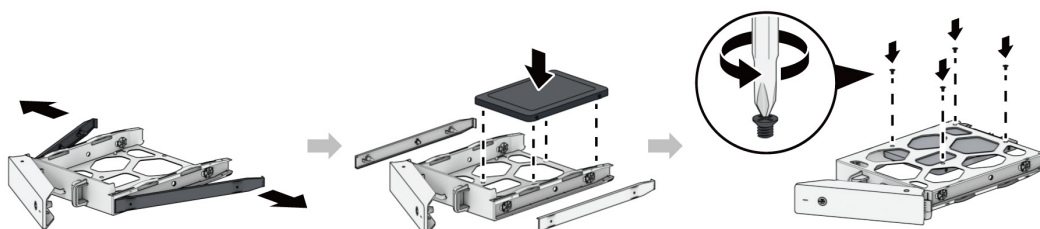

- 3 Insert the loaded drive tray into the empty drive bay and push it back until you hear a click when the tray is locked into place. Insert the drive tray key into the drive tray lock, turn the key clockwise (to the "I" position) to lock the drive tray handle, and then remove the key.

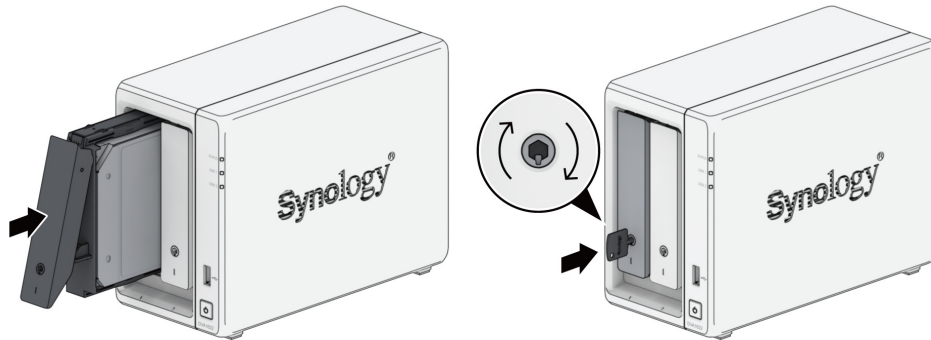

Note: Make sure that the drive tray is completely inserted. Otherwise, the drive might not function properly.

- 4 Repeat the steps above to install the other drives you have prepared.
- 5 Drives are numbered as shown below.



Note: If you plan to create a RAID volume, we recommend installing drives of identical size to make the best use of drive capacity.

Start up Your Network Video Recorder

- 1 Use the LAN cable to connect the Network Video Recorder to your switch, router, or hub.
- 2 Connect one end of the AC power adapter to the power port of your Network Video Recorder. Connect one end of the AC power cord to the AC power adapter, and the other to the power outlet.

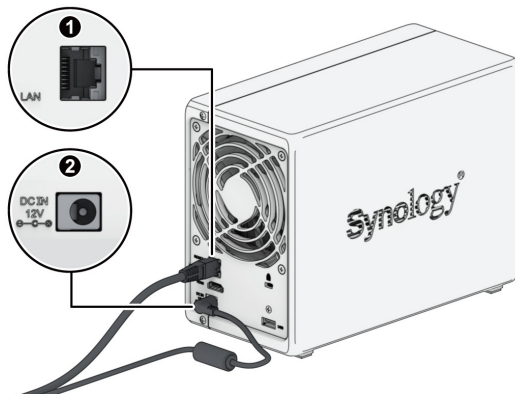

3 Press the power button to turn on your Network Video Recorder.

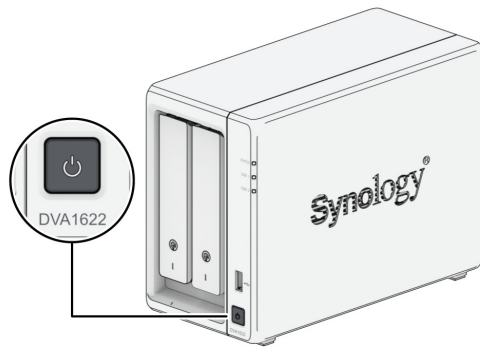

Congratulations! Your Network Video Recorder is now online and detectable from a network computer.

Install DSM on Network Video Recorder

After hardware setup is completed, please install DiskStation Manager (DSM) – Synology's browser-based operating system – on your DVA1622.

Install DSM

To install DSM with Web Assistant

Your DVA1622 comes with a built-in tool called **Web Assistant** that helps you download the latest version of DSM from the Internet and install it on your DVA1622. To use Web Assistant, please follow the steps below.

- 1 Power on your DVA1622.
- 2 Open a web browser on a computer connected to the same network as your DVA1622.
- 3 Enter either of the following into the address bar of your browser:
 - a find.synology.com
 - b `synologynvr:5000`
- 4 Web Assistant will be launched in your web browser. It will search for and find the Network Video Recorder within the local network. The status of your DVA1622 should be **Not Installed**.

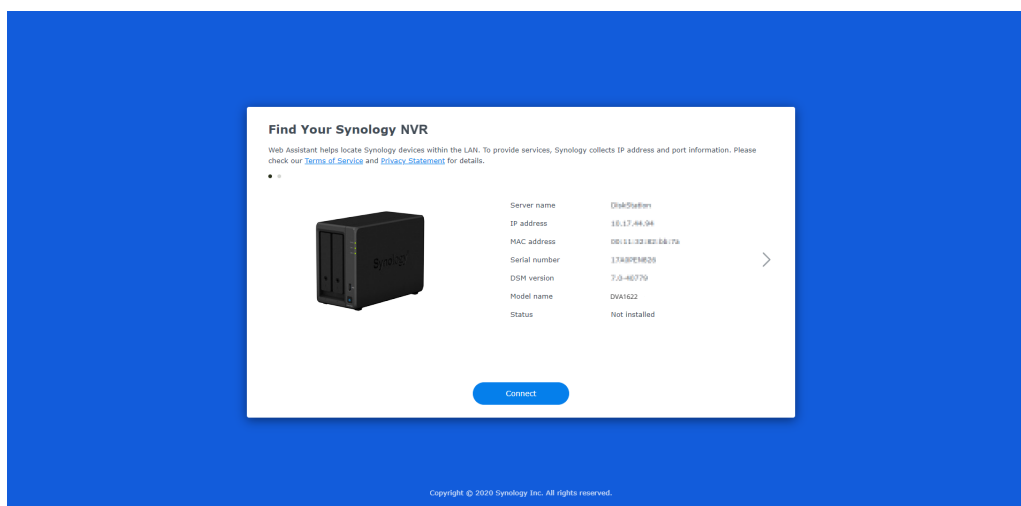

- 5 Click **Connect** to start the setup process and follow the onscreen instructions.

Note:

- The Network Video Recorder must be connected to the Internet to install DSM with Web Assistant.
- Recommended browsers: Chrome, Firefox.
- Both the Network Video Recorder and the computer must be in the same local network.

- 6 If you accidentally leave the installation process before it is finished, sign in to DSM as **admin** (default administrative account name) with the password left blank.

To install DSM and Surveillance Station from the device

You can also install DSM and Surveillance Station from your device. Please follow the steps below.

- 1 Use a HDMI cable to connect your DVA1622 to a screen.
- 2 Connect your DVA1622 to the Internet.
- 3 Connect a keyboard and a mouse to the USB port of the DVA1622.
- 4 Power on your DVA1622.

- 5 Press "Enter" to start the installation process. Your DVA1622 will automatically detect and install the newest version of DSM and Surveillance Station package.

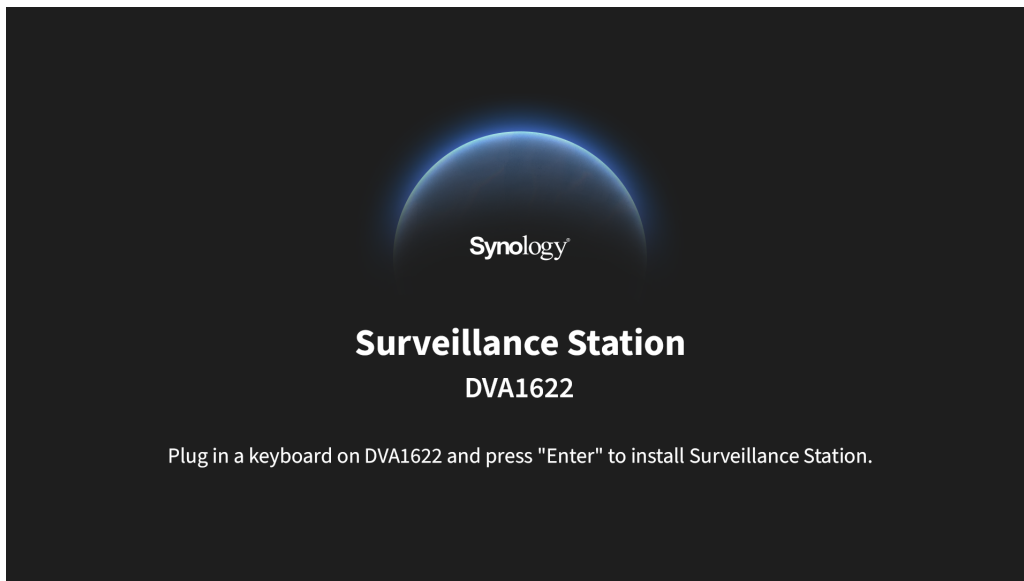

- 6 Once the installation has completed, you can create an administrator account.
- 7 You can now start using Surveillance Station.

Learn More

Your DVA1622 is now ready for action. For more information or online resources about your DVA1622, please visit [Synology's official website](#), which contains [step-by-step tutorials and frequently asked questions](#).

SYNOLOGY, INC. END USER LICENSE AGREEMENT

IMPORTANT—READ CAREFULLY: THIS END USER LICENSE AGREEMENT ("EULA") IS A LEGAL AGREEMENT BETWEEN YOU (EITHER AN INDIVIDUAL OR A LEGAL ENTITY) AND SYNOLOGY, INC. ("SYNOLOGY") FOR THE SYNOLOGY SOFTWARE INSTALLED ONTO THE SYNOLOGY PRODUCT PURCHASED BY YOU (THE "PRODUCT"), OR LEGALLY DOWNLOADED FROM WWW.SYNOLOGY.COM, OR ANY OTHER CHANNEL PROVIDED BY SYNOLOGY ("SOFTWARE").

YOU AGREE TO BE BOUND BY THE TERMS OF THIS EULA BY USING THE PRODUCTS CONTAINING THE SOFTWARE, INSTALLING THE SOFTWARE ONTO THE PRODUCTS OR DEVICE CONNECTED TO THE PRODUCTS. IF YOU DO NOT AGREE TO THE TERMS OF THIS EULA, DO NOT USE THE PRODUCTS CONTAINING THE SOFTWARE OR DOWNLOAD THE SOFTWARE FROM WWW.SYNOLOGY.COM, OR ANY OTHER CHANNEL PROVIDED BY SYNOLOGY. INSTEAD, YOU MAY RETURN THE PRODUCT TO THE RESELLER WHERE YOU PURCHASED IT FOR A REFUND IN ACCORDANCE WITH THE RESELLER'S APPLICABLE RETURN POLICY.

Section 1. Limited Software License. Subject to the terms and conditions of this EULA, Synology grants you a limited, non-exclusive, non-transferable, personal license to install, run and use one copy of the Software loaded on the Product or on your device connected to the Product solely relating to your authorized use of the Product.

Section 2. Documentation. You may make and use a reasonable number of copies of any documentation provided with the Software; provided that such copies will only be used for internal business purposes and are not to be republished or redistributed (either in hard copy or electronic form) to any third party.

Section 3. Backup. You may make a reasonable number of copies of the Software for backup and archival purposes only.

Section 4. Updates. Any software provided to you by Synology or made available on the Synology website at www.synology.com ("Website") or any other channel provided by Synology that updates or supplements the original Software is governed by this EULA unless separate license terms are provided with such updates or supplements, in which case, such separate terms will govern.

Section 5. License Limitations. The license set forth in Sections 1, 2 and 3 applies only to the extent that you have ordered and paid for the Product and states the entirety of your rights with respect to the Software. Synology reserves all rights not expressly granted to you in this EULA. Without limiting the foregoing, you shall not authorize or permit any third party to: (a) use the Software for any purpose other than that in connection with the Product; (b) license, distribute, lease, rent, lend, transfer, assign or otherwise dispose of the Software; (c) reverse engineer, decompile, disassemble or attempt to discover the source code of or any trade secrets related to the Software, except and only to the extent that such conduct is expressly permitted by applicable law notwithstanding this limitation; (d) adapt, modify, alter, translate or create any derivative works of the Software; (e) remove, alter or obscure any copyright notice or other proprietary rights notice on the Software or Product; or (f) circumvent or attempt to circumvent any methods employed by Synology to control access to the components, features or functions of the Product or Software. Subject to the limitations specified in this Section 5, you are not prohibited from providing any services hosted by Synology NAS server to any third party for commercial purpose.

Section 6. Open Source. The Software may contain components licensed to Synology under the GNU General Public License ("GPL Components"), currently available at <http://www.gnu.org/licenses/gpl.html>. The terms of the GPL will control solely with respect to the GPL Components to the extent that this EULA conflicts with the requirements of the GPL with respect to your use of the GPL Components, and, in such event, you agree to be bound by the GPL with respect to your use of such components.

Section 7. Audit. Synology will have the right to audit your compliance with the terms of this EULA. You agree to grant Synology a right to access to your facilities, equipment, books, records and documents and to otherwise reasonably cooperate with Synology in order to facilitate any such audit by Synology or its agent authorized by Synology.

Section 8. Ownership. The Software is a valuable property of Synology and its licensors, protected by copyright and other intellectual property laws and treaties. Synology or its licensors own all rights, titles and interests in and to the Software, including but not limited to copyright and any other intellectual property rights.

Section 9. Limited Warranty. Synology provides a limited warranty that the Software will substantially conform to Synology's published specifications for the Software, if any, or otherwise set forth on the Website, for a period required by your local law. Synology will use commercially reasonable efforts to, in Synology's sole discretion, either correct any such nonconformity in the Software or replace any Software that fails to comply with the foregoing warranty, provided that you give Synology written notice of such noncompliance within the warranty period. The foregoing warranty does not apply to any noncompliance resulting from any: (w) use, reproduction, distribution or disclosure not in accordance with this EULA; (x) any customization, modification or other alteration of the Software by anyone other than Synology; (y) combination of the Software with any product, services or other items provided by anyone other than Synology; or (z) your failure to comply with this EULA.

Section 10. Support. During the period specified in the Section 9, Synology will make available to you the support services. Following the expiration of the applicable period, support for Software may be available from Synology upon written

request.

Section 11. Disclaimer of Warranties. EXCEPT AS EXPRESSLY SET FORTH ABOVE, THE SOFTWARE IS PROVIDED "AS IS" AND WITH ALL FAULTS. SYNOLOGY AND ITS SUPPLIERS HEREBY DISCLAIM ALL OTHER WARRANTIES, EXPRESS, IMPLIED OR STATUTORY, ARISING BY LAW OR OTHERWISE, INCLUDING BUT NOT LIMITED TO ANY IMPLIED WARRANTIES OF MERCHANTABILITY, FITNESS FOR A PARTICULAR PURPOSE OR USE, TITLE AND NON-INFRINGEMENT, WITH REGARD TO THE SOFTWARE. WITHOUT LIMITING THE FOREGOING, SYNOLOGY DOES NOT WARRANT THAT THE SOFTWARE WILL BE FREE OF BUGS, ERRORS, VIRUSES OR OTHER DEFECTS.

Section 12. Disclaimer of Certain Damages. IN NO EVENT WILL SYNOLOGY OR ITS LICENSORS BE LIABLE FOR ANY INCIDENTAL, INDIRECT, SPECIAL, PUNITIVE, CONSEQUENTIAL OR SIMILAR DAMAGES OR LIABILITIES WHATSOEVER (INCLUDING, BUT NOT LIMITED TO LOSS OF DATA, INFORMATION, REVENUE, PROFIT OR BUSINESS) ARISING OUT OF OR RELATING TO THE USE OF OR INABILITY TO USE THE SOFTWARE OR OTHERWISE UNDER OR IN CONNECTION WITH THIS EULA OR THE SOFTWARE, WHETHER BASED ON CONTRACT, TORT (INCLUDING NEGLIGENCE), STRICT LIABILITY OR OTHER THEORY EVEN IF SYNOLOGY HAS BEEN ADVISED OF THE POSSIBILITY OF SUCH DAMAGES.

Section 13. Limitation of Liability. SYNOLOGY'S AND ITS SUPPLIERS' LIABILITY ARISING OUT OF OR RELATING TO THE USE OF OR INABILITY TO USE THE SOFTWARE OR OTHERWISE UNDER OR IN CONNECTION WITH THIS EULA OR THE SOFTWARE IS LIMITED TO THE AMOUNT ACTUALLY PAID BY YOU FOR THE PRODUCT REGARDLESS OF THE AMOUNT OF DAMAGES YOU MAY INCUR AND WHETHER BASED ON CONTRACT, TORT (INCLUDING NEGLIGENCE), STRICT LIABILITY OR OTHER THEORY. The foregoing disclaimer of warranties, disclaimer of certain damages and limitation of liability will apply to the maximum extent permitted by applicable law. The laws of some states/jurisdictions do not allow the exclusion of implied warranties or the exclusion or limitation of certain damages. To the extent that those laws apply to this EULA, the exclusions and limitations set forth above may not apply to you.

Section 14. Export Restrictions. You acknowledge that the Software is subject to U.S. export restrictions. You agree to comply with all applicable laws and regulations that apply to the Software, including without limitation the U.S. Export Administration Regulations.

Section 15. Termination. Without prejudice to any other rights, Synology may terminate this EULA if you do not abide by the terms and conditions contained herein. In such event, you must cease use of the Software and destroy all copies of the Software and all of its component parts.

Section 16. Assignment. You may not transfer or assign your rights under this EULA to any third party, except for that pre-installed in the Products. Any such transfer or assignment in violation of the foregoing restriction will be void.

Section 17. Applicable Law. Unless expressly prohibited by local law, this EULA is governed by and construed in accordance with the laws of the country, in accordance with which Synology Inc. was organized without regard to any conflict of law principles to the contrary.

Section 18. Dispute Resolution. Any dispute, controversy or claim arising out of or relating to this EULA will be resolved exclusively and finally by arbitration conducted by three neutral arbitrators in accordance with the procedures of the Arbitration Law and related enforcement rules of the country in which Synology Inc. was organized. In such cases, the arbitration will be limited solely to the dispute between you and Synology. The arbitration, or any portion of it, will not be consolidated with any other arbitration and will not be conducted on a class-wide or class action basis. The arbitration shall take place in Taipei and the arbitration proceedings shall be conducted in English or, if both parties so agree, in Mandarin Chinese. The arbitration award shall be final and binding on the parties and may be enforced in any court having jurisdiction. You understand that, in the absence of this provision, you would have had a right to litigate any such dispute, controversy or claim in a court, including the right to litigate claims on a class-wide or class-action basis, and you expressly and knowingly waive those rights and agree to resolve any disputes through binding arbitration in accordance with the provisions of this Section 18. Nothing in this Section shall be deemed to prohibit or restrict Synology from seeking injunctive relief or seeking such other rights and remedies as it may have at law or equity for any actual or threatened breach of any provision of this EULA relating to Synology's intellectual property rights.

Section 19. Attorneys' Fees. In any arbitration, mediation, or other legal action or proceeding to enforce rights or remedies under this EULA, the prevailing party will be entitled to recover, in addition to any other relief to which it may be entitled, costs and reasonable attorneys' fees.

Section 20. Severability. If any provision of this EULA is held by a court of competent jurisdiction to be invalid, illegal, or unenforceable, the remainder of this EULA will remain in full force and effect.

Section 21. Entire Agreement. This EULA sets forth the entire agreement of Synology and you with respect to the Software and the subject matter hereof and supersedes all prior and contemporaneous understandings and agreements whether written or oral. No amendment, modification or waiver of any of the provisions of this EULA will be valid unless set forth in a written instrument signed by the party to be bound thereby.

SYNOLOGY, INC. LIMITED PRODUCT WARRANTY

THIS LIMITED WARRANTY ("WARRANTY") APPLIES TO THE PRODUCTS (AS DEFINED BELOW) OF SYNOLOGY, INC. AND ITS AFFILIATES, INCLUDING SYNOLOGY AMERICA CORP, (COLLECTIVELY, "SYNOLOGY"). YOU ACCEPT AND AGREE TO BE BOUND BY THE TERMS OF THIS WARRANTY BY OPENING THE PACKAGE CONTAINING AND/OR USING THE PRODUCT. PLEASE BE ADVISED THAT THIS LIMITED WARRANTY DOES NOT APPLY TO THE SOFTWARE CONTAINED IN THE PRODUCTS WHICH SHALL BE SUBJECT TO ITS END USER LICENSE AGREEMENT, AND THAT SYNOLOGY RESERVES THE RIGHT TO MAKE ADJUSTMENTS AND/OR MODIFICATION TO THIS PRODUCT WARRANTY FROM TIME TO TIME WITHOUT PROVIDING PRIOR NOTICE TO YOU. IF YOU DO NOT AGREE TO THE TERMS OF THIS WARRANTY, DO NOT USE THE PRODUCT. INSTEAD, YOU MAY RETURN THE PRODUCT TO THE RESELLER WHERE YOU PURCHASED IT FOR A REFUND IN ACCORDANCE WITH THE RESELLER'S APPLICABLE RETURN POLICY.

PLEASE NOTE THAT SYNOLOGY'S WARRANTY SUPPORTS ARE NOT AVAILABLE IN EVERY COUNTRY, AND THAT SYNOLOGY MAY REFUSE TO PROVIDE THIS LIMITED WARRANTY SUPPORTS TO YOU IF YOU REQUEST SUCH SUPPORTS NOT AT THE COUNTRY AT WHICH THE PRODUCT WAS ORIGINALLY PURCHASED. THE COUNTRY AT WHICH THE PRODUCT WAS ORIGINALLY PURCHASED SHALL BE DETERMINED BASED ON THE SYNOLOGY'S INTERNAL RECORDS.

Section 1. Products

(a) "Products" refer to New Products or Refurbished Products.

(b) "New Product" means the Synology-branded hardware product and Synology-branded accessories contained in the original packaging Customer bought from an authorized Synology distributor or reseller. You may see our "New Product" at [Product Support Status](#).

(c) "Refurbished Product" means all Synology products which have been refurbished by Synology's affiliate or an authorized Synology distributor or reseller, not including those sold as "as is" or with "no warranty" by anyone.

(d) Other definition: "Customer" means the original person or entity purchasing the Product from Synology or an authorized Synology distributor or reseller; "Online Store" means an online shop operated by Synology or Synology's affiliate;

"Software" means the Synology proprietary software that accompanies the Product when purchased by Customer, is downloaded by Customer from the Web Site, or is pre-installed on the Product by Synology, and includes any firmware, associated media, images, animations, video, audio, text and applets incorporated into the software or Product and any updates or upgrades to such software.

Section 2. Warranty Period

(a) "Warranty Period": The warranty period commences on the purchase date is shown on the purchase receipt or invoice to be presented by Customer and ending at the day after the end of the Warranty Period for each New Product. You may see the Warranty Period for each New Product at [Product Support Status](#). For the Refurbished Product or repaired parts, it's the remainder of the warranty period of the product they are replacing, or ninety (90) days from the date the product was replaced or repaired, whichever is longer; except for those sold as "as is" or with "no warranty" by any stores. Without presenting such purchase receipt or invoice, the warranty period shall commence on the date of manufacture based on our internal record.

(b) "Extended Warranty Period": For Customer purchasing EW201/ EW202 optional service for applicable Products specified in Section 1 (b), the Warranty Period specified in Section 2 (a) of the applicable Product registered with EW201/EW202 optional service will be extended by two years. You may see the applied model at [Extended Warranty](#).

(c) "Immediate termination of Warranty Period": As to the Synology drive product, its warrant period will terminate immediately upon either of following situations occurs: (a) for solid-state drive, its lifespan wear-out indicator is equal to or exceeds the limit specified in the "product specifications" of the drive attached with the purchased product; (b) for all drive products, its temperature record is equal to or exceeds the operating temperature limit of the drive, which is specified in the "product specifications" attached with the purchased product.

Section 3. Limited Warranty and Remedies

3.1 Limited Warranty. Subject to Section 3.2, Synology warrants to the Customer that each Product (a) will be free of material defects in workmanship and (b) under normal use will perform substantially in accordance with Synology's published specifications for the Product during the Warranty Period. Such limited warranty does not apply to the Software contained in the product or purchased by Customer which shall be subject to the accompanying end user license agreement provided with the Product. Synology provides no warranty to Refurbished Product sold as "as is" or with "no warranty". (c) This Limited Warranty is NOT transferable and applies only to the customers who directly purchase products from Synology's affiliate, the resellers, and distributor that Synology authorized. The warranty set forth in Section 3 will terminate upon Customer's sale or transfer of the Product to a third party.

3.2 Exclusions. The foregoing warranties and warranty obligations do not apply to any Product that (a) has been installed or used in a manner not specified or described in the Product, specifications, or its related documents, or in any way misused, abused, or damaged; (b) has been damaged caused by accident, fire, liquid contact, earthquake, other external factor or product use in improper environment; (c) has been disassembled without authorization from Synology; or (d) with cosmetic damage caused by normal wear and tear or otherwise due to the normal aging of the Product, including but not limited to scratches, dents and broken plastic on ports unless failure has occurred due to a defect in materials or

workmanship; (e) serial number has been removed or defaced from Product, resulting in not able to identify; (f) has been damaged or out of order because Customer fails to implement any correction, modification, enhancement, improvement or other update made available to Customer by Synology, or because Customer implements, installs or uses any correction, modification, enhancement, improvement or other update made available by any third party; (g) has been damaged, out-of-order, or incompatible due to installation or use with items not provided by Synology other than the hardware, software or other accessory for which the Product is designed.

Please note that each of the above situations shall be subject to the inspection and verification of the product's appearance and functions by Synology.

3.3 Warranty Support and Exclusive Remedy. If Customer gives notice of noncompliance with any of the warranties set forth in Section 3.1 within the applicable Warranty Period in the manner set forth below, then, upon verification of the noncompliance by Synology, Synology will, at Synology's option: (a) use commercially reasonable efforts to repair the Product, (b) provide technical support, or (c) replace the noncomplying Product or part thereof upon return of the complete Product in accordance with Section 3.4. The foregoing sets forth Synology's entire liability and Customer's sole and exclusive remedy for any breach of warranty under Section 3.1 or any other defect or deficiency in the Product. Customer will reasonably assist Synology to diagnose and validate any nonconformity with the Product. Please note that the warranty support does not apply to rescue of the data stored in Synology Product or its backup. Customer shall make a backup copy of the stored data before it returns the Product to Synology, Synology may weed up all information or data in the Product while it performs the warranty services and shall not be responsible or liable for any data loss therein.

3.4 Return. Any Product return by Customer under Section 3.3 must be made in accordance with Synology's then-current return procedures with the purchase receipt or invoice. You may see more information about the return procedure at [How do I make a warranty claim for my Synology product?](#) For warranty claims, the Customer must return the complete Product to Synology in accordance with this Section 3.4. Any returned Product that (a) has been disassembled (except under the direction of Synology); or (b) serial number has been removed or defaced from Product, resulting in not able to identify, or (c) was damaged on the way of return due to improper packaging (including but not limited to scratches and deformation), will be refused and returned to Customer at Customer's expense. Any Product must be returned in the same condition as it was received from Synology to the address designated by Synology, freight pre-paid, in packaging sufficient to protect the contents thereof. Customer is responsible for insurance and risk of loss/damage with respect to returned items until they are properly received by Synology.

3.5 Replacement of New Product or Refurbished Product by Synology. If Synology elects to replace any Product under this Warranty set forth in Section 3.1, then Synology will ship a replacement Product at Synology's expense via the shipping method selected by Synology after receipt of the nonconforming Product returned in accordance with Section 3.4 and validation by Synology that the Product does not conform to the warranty. Before the shipment of the Refurbished Product to the Customers, they have been verified to strictly comply with Synology's quality standard. Please note that part of the Refurbished Products would be with certain stain, scratches, or other minor wear and tear. In some countries, Synology may at its own discretion apply the Synology Replacement Service to certain Products, through which Synology will ship a replacement Product to Customer before its receipt of the nonconforming Product returned by Customer ("Synology Replacement Service").

3.6 Disclaimer of Warranties. THE WARRANTIES, OBLIGATIONS, AND LIABILITIES OF SYNOLOGY AND THE REMEDIES OF CUSTOMER SET FORTH IN THIS WARRANTY ARE EXCLUSIVE AND IN SUBSTITUTION FOR, AND CUSTOMER HEREBY WAIVES, RELEASES AND DISCLAIMS, ALL OTHER WARRANTIES, OBLIGATIONS AND LIABILITIES OF SYNOLOGY AND ALL OTHER RIGHTS, CLAIMS AND REMEDIES OF CUSTOMER AGAINST SYNOLOGY, EXPRESS OR IMPLIED, ARISING BY LAW OR OTHERWISE, WITH RESPECT TO THE PRODUCT, ACCOMPANYING DOCUMENTATION OR SOFTWARE AND ANY OTHER GOODS OR SERVICES DELIVERED UNDER THIS WARRANTY, INCLUDING, BUT NOT LIMITED TO ANY: (A) IMPLIED WARRANTY OF MERCHANTABILITY OR FITNESS FOR A PARTICULAR PURPOSE OR USE; (B) IMPLIED WARRANTY ARISING FROM COURSE OF PERFORMANCE, COURSE OF DEALING, OR USAGE OF TRADE; (C) CLAIM OF INFRINGEMENT OR MISAPPROPRIATION; OR (D) CLAIM IN TORT (WHETHER BASED ON NEGLIGENCE, STRICT LIABILITY, PRODUCT LIABILITY OR OTHER THEORY). SYNOLOGY MAKES NO GUARANTEE AND SPECIFICALLY DISCLAIMS ANY WARRANTY THAT THE DATA OR INFORMATION STORED ON ANY SYNOLOGY PRODUCT WILL BE SECURE AND WITHOUT RISK OF DATA LOSS. SYNOLOGY RECOMMENDS THAT CUSTOMER TAKES APPROPRIATE MEASURES TO BACK UP THE DATA STORED ON THE PRODUCT. SOME STATES/JURISDICTIONS DO NOT ALLOW LIMITATIONS ON IMPLIED WARRANTIES, SO THE ABOVE LIMITATION MAY NOT APPLY TO CUSTOMER.

Section 4. Limitations of Liability

4.1 Force Majeure. Synology will not be liable for, or be considered to be in breach of or default under this Warranty on account of, any delay or failure to perform as required by this Warranty as a result of any cause or condition beyond its reasonable control (including, without limitation, any act or failure to act by Customer).

4.2 Disclaimer of Certain Damages. IN NO EVENT WILL SYNOLOGY OR ITS SUPPLIERS BE LIABLE FOR THE COST OF COVER OR FOR ANY INCIDENTAL, INDIRECT, SPECIAL, PUNITIVE, CONSEQUENTIAL OR SIMILAR DAMAGES OR LIABILITIES WHATSOEVER (INCLUDING, BUT NOT LIMITED TO LOSS OF DATA, INFORMATION, REVENUE,

PROFIT OR BUSINESS) ARISING OUT OF OR RELATING TO THE USE OR INABILITY TO USE THE PRODUCT, ANY ACCOMPANYING DOCUMENTATION OR SOFTWARE AND ANY OTHER GOODS OR SERVICES PROVIDED UNDER THIS WARRANTY, WHETHER BASED ON CONTRACT, TORT (INCLUDING NEGLIGENCE), STRICT LIABILITY OR OTHER THEORY EVEN IF SYNOLOGY HAS BEEN ADVISED OF THE POSSIBILITY OF SUCH DAMAGES.

4.3 Limitation of Liability. SYNOLOGY'S AND ITS SUPPLIERS' LIABILITY ARISING OUT OF OR RELATING TO THE USE OR INABILITY TO USE THE PRODUCT, ANY ACCOMPANYING DOCUMENTATION OR SOFTWARE AND ANY OTHER GOODS OR SERVICES PROVIDED UNDER THIS WARRANTY IS LIMITED TO THE AMOUNT ACTUALLY PAID BY CUSTOMER FOR THE PRODUCT REGARDLESS OF THE AMOUNT OF DAMAGES CUSTOMER MAY INCUR AND WHETHER BASED ON CONTRACT, TORT (INCLUDING NEGLIGENCE), STRICT LIABILITY OR OTHER THEORY. The foregoing disclaimer of certain damages and limitation of liability will apply to the maximum extent permitted by applicable law. The laws of some states/jurisdictions do not allow exclusion or limitation of certain damages. To the extent that those laws apply to the Product, the exclusions and limitations set forth above may not apply to Customer.

Section 5. Miscellaneous

5.1 Proprietary Rights. The Product and any accompanying Software and documentation provided with the Product include proprietary and intellectual property rights of Synology and its third party suppliers and licensors. Synology retains and reserves all right, title, and interest in the intellectual property rights of the Product, and no title to or ownership of any intellectual property rights in or to the Product, any accompanying Software or documentation and any other goods provided under this Warranty is transferred to Customer under this Warranty. Customer will (a) comply with the terms and conditions of the Synology end user license agreement accompanying any Software furnished by Synology or an authorized Synology distributor or reseller; and (b) not attempt to reverse engineer any Product or component thereof or accompanying Software or otherwise misappropriate, circumvent or violate any of Synology's intellectual property rights.

5.2 Assignment. Customer will not assign any of its rights under this Warranty directly, by operation of law or otherwise, without the prior written consent of Synology.

5.3 No Additional Terms. Except as expressly permitted by this Warranty, neither party will be bound by, and each party specifically objects to, any term, condition or other provision that conflicts with the provisions of this Warranty that is made by the other party in any purchase order, receipt, acceptance, confirmation, correspondence or otherwise, unless each party specifically agrees to such provision in writing. Further, if this Warranty conflicts with any terms or conditions of any other agreement entered into by the parties with respect to the Product, this Warranty will prevail unless the other agreement specifically references the sections of this Warranty that it supersedes.

5.4 Applicable Law. Unless explicitly prohibited by local law, this Warranty is governed by the laws of the State of Washington, U.S.A. for the Customers residing within the United States; and by the laws of the Republic of China (Taiwan) for Customers not residing within the United States, without regard to any conflict of law principles to the contrary. The 1980 U.N. Convention on Contracts for the International Sale of Goods or any successor thereto does not apply.

5.5 Dispute Resolution. Any dispute, controversy or claim arising out of or relating to this Warranty, the Product or services provided by Synology with respect to the Product or the relationship between Customers residing within the United States and Synology will be resolved exclusively and finally by arbitration under the current commercial rules of the American Arbitration Association, except as otherwise provided below. The arbitration will be conducted before a single arbitrator, and will be limited solely to the dispute between Customer and Synology. The arbitration, or any portion of it, will not be consolidated with any other arbitration and will not be conducted on a class-wide or class action basis. The arbitration shall be held in King County, Washington, U.S.A. by submission of documents, by telephone, online or in person as determined by the arbitrator at the request of the parties. The prevailing party in any arbitration or legal action occurring within the United States or otherwise shall receive all costs and reasonable attorneys' fees, including any arbitration fee paid by the prevailing party. Any decision rendered in such arbitration proceedings will be final and binding on the parties, and judgment may be entered thereon in any court of competent jurisdiction. Customer understands that, in the absence of this provision, Customer would have had a right to litigate any such dispute, controversy or claim in a court, including the right to litigate claims on a class-wide or class-action basis, and Customer expressly and knowingly waives those rights and agrees to resolve any disputes through binding arbitration in accordance with the provisions of this Section 5.5. For Customers not residing within the United States, any dispute, controversy or claim described in this section shall be finally resolved by arbitration conducted by three neutral arbitrators in accordance with the procedures of the R.O.C. Arbitration Law and related enforcement rules. The arbitration shall take place in Taipei, Taiwan, R.O.C., and the arbitration proceedings shall be conducted in English or, if both parties so agree, in Mandarin Chinese. The arbitration award shall be final and binding on the parties and may be enforced in any court having jurisdiction. Nothing in this Section shall be deemed to prohibit or restrict Synology from seeking injunctive relief or seeking such other rights and remedies as it may have at law or equity for any actual or threatened breach of any provision of this Warranty relating to Synology's intellectual property rights.

5.6 Attorneys' Fees. In any arbitration, mediation, or other legal action or proceeding to enforce rights or remedies under

this Warranty, the prevailing party will be entitled to recover, in addition to any other relief to which it may be entitled, costs and reasonable attorneys' fees.

5.7 Export Restrictions. You acknowledge that the Product may be subject to U.S. export restrictions. You will comply with all applicable laws and regulations that apply to the Product, including without limitation the U.S. Export Administration Regulations.

5.8 Severability. If any provision of this Warranty is held by a court of competent jurisdiction to be invalid, illegal, or unenforceable, the remainder of this Warranty will remain in full force and effect.

5.9 Entire Agreement. This Warranty constitutes the entire agreement, and supersedes any and all prior agreements, between Synology and Customer related to the subject matter hereof. No amendment, modification or waiver of any of the provisions of this Warranty will be valid unless set forth in a written instrument signed by the party to be bound thereby.

FCC Declaration of Conformity

This device complies with Part 15 of the FCC Rules. Operation is subject to the following two conditions: (1) this device may not cause harmful interference, and (2) this device must accept any interference received, including interference that may cause undesired operation.

この装置は、クラス B 機器です。この装置は、住宅環境で使用することを目的としていますが、この装置がラジオやテレビジョン受信機に近接して使用されると、受信障害を引き起こすことがあります。

取扱説明書に従って正しい取り扱いをして下さい。

VCCI — B