

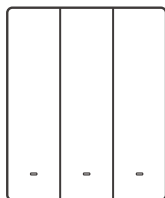

# SwitchMan M5

User manual V1.1



80

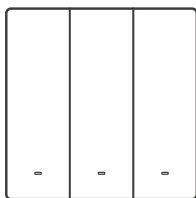

86

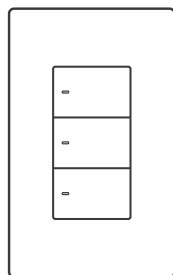

120

## SwitchMan Smart Wall Switch

## Product Introduction

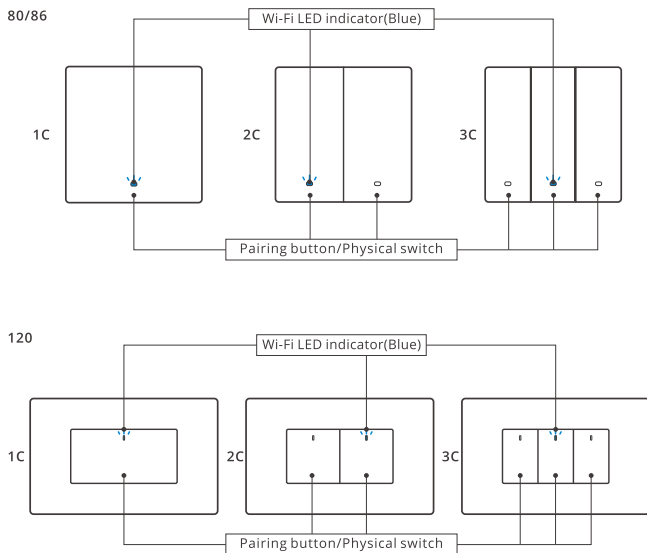

⚠ The device weight is less than 1 kg. The installation height of less than 2 m is recommended.

## Wi-Fi LED indicator status instruction

Wi-Fi LED indicator status	Status instruction
Flashes (one long and two short)	Bluetooth Pairing Mode
Flashes quickly	Compatible Pairing Mode
Keeps on	Device is Online
Flashes quickly once	Fail to Connect to Router
Flashes quickly twice	Connected to Router but Fail to Connect to Serve
Flashes quickly three times	Firmware Updating

## Features

This device is a smart physical wall switch. After pairing it with eWeLink App, you can turn on/off the connected devices via the smart phone wherever you are, schedule its on/off, share it with your families to control together, etc.



Remote Control



Single/Countdown  
Timing



Voice Control



Share Control



Smart Scene



Inching Mode



Camera Linking



Group Control



History Operation  
Record



LAN Control

## Operating Instruction

### 1. Power off

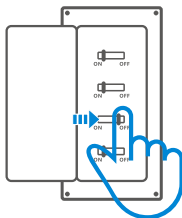

⚠ Please install and maintain the device by a professional electrician. To avoid electric shock hazard, do not operate any connection or contact the terminal connector while the device is powered on !

## 2. Wiring instruction

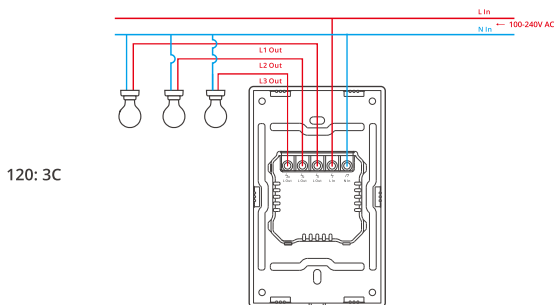
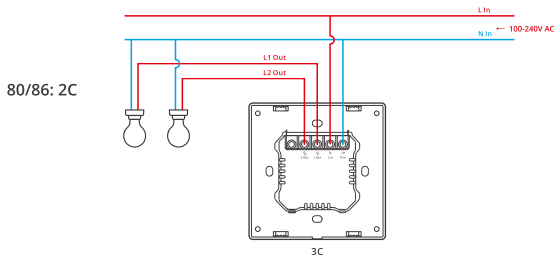

⚠ Make sure all wires are connected correctly.

## 3. Download the eWeLink App

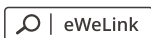

Android™ & iOS

#### 4. Power on

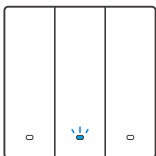

After powering on, the device will enter the Bluetooth Pairing Mode during the first use. The Wi-Fi LED indicator changes in a cycle of two short and one long flash and release.

- ⓘ The device will exit the Bluetooth Pairing Mode if not paired within 3mins. If you want to enter this mode, please long press any pairing button for about 5s until the Wi-Fi LED indicator changes in a cycle of two short and one long flash and release.

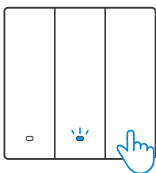

#### 5. Add device

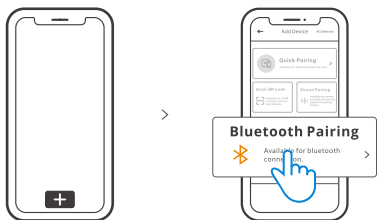

Tap "+" and select "Bluetooth Pairing", then operate following the prompt on the App.

## Compatible Pairing Mode

If you fail to enter Bluetooth Pairing Mode, please try “Compatible Pairing Mode” to pair.

① Long press any Pairing button for 5s until the Wi-Fi LED indicator changes in a cycle of two short flashes and one long flash and release. Long press any Pairing button for 5s again until the Wi-Fi LED indicator flashes quickly. Then, the device enters Compatible Pairing Mode.

② Tap “+” and select “Compatible Pairing Mode” on App.

Enter Wi-Fi password, tap “Next” and then “Connect”. Select Wi-Fi SSID with ITEAD-\*\*\*\*\* and enter the password 12345678, and then go back to eWeLink app and tap “Next”. Be patient until pairing completes.

## Specifications

Model	M5-1C-80, M5-2C-80, M5-3C-80 M5-1C-86, M5-2C-86, M5-3C-86 M5-1C-120, M5-2C-120, M5-3C-120
Input	1C: 100-240V ~ 50/60Hz 10A Max 2C: 100-240V ~ 50/60Hz 10A Max 3C: 100-240V ~ 50/60Hz 6A Max
Output	1C: 100-240V ~ 50/60Hz 10A Max 2C: 100-240V ~ 50/60Hz 5A/Gang 10A/Total Max 3C: 100-240V ~ 50/60Hz 2A/Gang 6A/Total Max
Max. load	1C: 2200W 2C: 2200W(1-1100W/Gang) 3C: 1320W(1-440W/Gang)
LED load	1C: 300W/220V, 150W/110V 2C: 300W/220V/Gang, 150W/110V/Gang 3C: 100W/220V/Gang, 600W/110V/Gang
Wi-Fi	IEEE 802.11 b/g/n 2.4GHz
Bluetooth Standard	4.2 BLE
App operating systems	Android & iOS
Working temperature	-10°C~40°C
Shell material	PC V0
Dimension	80: 86x71x41.5mm 86: 86x86x41.5mm 120: 120x74x41.5mm

## Factory Reset

Deleting the device on the eWeLink App indicates you restore it to factory setting.

## Common Problems

### Fail to pair Wi-Fi devices with eWeLink APP

1. Make sure the device is in pairing mode.  
The device will automatically exit the pairing mode if not paired within 3mins.
2. Please turn on the location service on your mobile phone and give the permission.  
Before choosing the Wi-Fi network, the location service should be turned on and the permission is given. Location information permission is used to obtain Wi-Fi list information. If you tap "Disable", the device will not be added.
3. Make sure your Wi-Fi network runs on the 2.4GHz band.
4. Make sure you entered a correct Wi-Fi SSID and password, no special characters contained. A wrong password is a very common reason for pairing failure.
5. You may get the device close to the router for a good signal transmission while pairing.
6. Please try to pair the device in the compatible mode.

### Wi-Fi devices "Offline" issues

Please check the following issues by the Wi-Fi LED indicator status:

The LED indicator blinks once every 2s means you fail to connect to the router.

1. Maybe you entered a wrong Wi-Fi SSID and password.
2. Make sure your Wi-Fi SSID and password don't contain special characters, for example, the Hebrew, Arabic characters. Our system can't recognize these characters so that fail to connect to the Wi-Fi.
3. Maybe your router has a lower carrying capacity.
4. Maybe the Wi-Fi signal strength is weak. Your router is too far away from your device, or there may be some obstacles between the router and the device so that the signal transmission is blocked.
5. Be sure that the MAC of the device is not on the blacklist of your MAC management.

### The LED indicator flashes twice on repeated means you fail to connect to the server.

1. Make sure the Internet connection is normal. You can use your phone or PC to connect to the Internet, and if you fail to access, please check the availability of the Internet connection.
2. Maybe your router has a low carrying capacity. The number of devices connected to the router exceeds its maximum value. Please check the maximum number of devices that your router can carry. If the number of connected devices exceeds the maximum value, please delete some devices or change a larger router and try again.
3. Please contact your ISP and confirm our server address is not shielded:  
cn-disp.coolkit.cc (China Mainland)  
as-disp.coolkit.cc (in Asia except China)  
eu-disp.coolkit.cc (in EU)  
us-disp.coolkit.cc (in US)

If none of the above methods solved this problem, please submit your issue via help & feedback on the eWeLink App.

## FCC Warning

Changes or modifications not expressly approved by the party responsible for compliance could avoid the user's authority to operate the equipment.

This device complies with part 15 of the FCC Rules. Operation is subject to the following two conditions: (1) This device may not cause harmful interference, and (2) this device must accept any interference received, including interference that may cause undesired operation.

### **FCC Radiation Exposure Statement:**

This equipment complies with FCC radiation exposure limits set forth for an uncontrolled environment. This equipment should be installed and operated with minimum distance 20cm between the radiator & your body. This transmitter must not be co-located or operating in conjunction with any other antenna or transmitter.

### **Note:**

This equipment has been tested and found to comply with the limits for a Class B digital device, pursuant to part 15 of the FCC Rules. These limits are designed to provide reasonable protection against harmful interference in a residential installation. This equipment generates, uses and can radiate radio frequency energy and, if not installed and used in accordance with the instructions, may cause harmful interference to radio communications. However, there is no guarantee that interference will not occur in a particular installation. If this equipment does cause harmful interference to radio or television reception, which can be determined by turning the equipment off and on, the user is encouraged to try to correct the interference by one or more of the following measures:

- Reorient or relocate the receiving antenna.
- Increase the separation between the equipment and receiver.
- Connect the equipment into an outlet on a circuit different from that to which the receiver is connected.
- Consult the dealer or an experienced radio/TV technician for help.



Hereby, Shenzhen Sonoff Technologies Co., Ltd. declares that the radio equipment type M5-1C-80, M5-2C-80, M5-3C-80, M5-1C-86, M5-2C-86, M5-3C-86, M5-1C-120, M5-2C-120, M5-3C-120 are in compliance with Directive 2014/53/EU. The full text of the EU declaration of conformity is available at the following internet address:

<https://sonoff.tech/usermanuals>



## Shenzhen Sonoff Technologies Co., Ltd.

3F & 6F, Bldg A, No. 663, Bulong Rd, Shenzhen, Guangdong, China  
ZIP code: 518000 Website: sonoff.tech

MADE IN CHINA

