

JM-VL03

GNSS VEHICLE TERMINAL

USER MANUAL

V2.2



Product overview

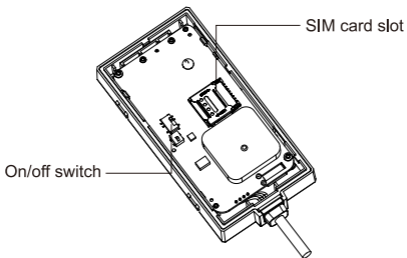
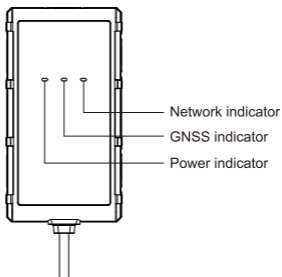

Real-time tracking
Driving behavior analysis (4 types)
Serial port (optional)
Over-speed alert
SOS alert
Tamper alert
Removal alert
Power-supply-cut alert
Low power alert
Vibration alert
Geo-fence

Standard Parts List

Item	Quantity
JM-VL03	1
Power cable (Length:1m)	1
Relay	Optional
Panic button	Optional

Specification

Network	4G & 2G
Frequency	JM-VL03E: FDD: B1/B3/B5/B7/B8/B20 TDD: B34/B38/B39/B40/B41 GSM: 900/1800 MHz
	JM-VL03A: LTE: B1/B3/B7/B8/B28 GSM: 850/900/1800/1900 MHz
	JM-VL03M: LTE: B2/B4/B5/B7/B12/B13 GSM: 850/900/1800/1900 MHz
Location accuracy	<10 meters CEP
Relay	Optional
TTF (open sky)	Avg. hot start≤1sec Avg. cold start≤32sec
Indication	GPS (Blue), Cellular (Green), Power (Red)
Battery	60mAh, 3.7V Li-Polymer battery (270mAh/3.7V optional)
Operating voltage	9-90VDC
Operating temperature	-20°C to +70°C
Device weight	69g
Device dimension	94.3mm*50.4mm*15.0mm

Product Setup

1. Prepare a micro SIM card that supports the same network with this device.



2. Remove the upper cover of device.

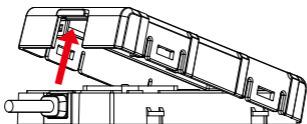

3. Insert SIM card into the slot and toggle the switch to **ON**.

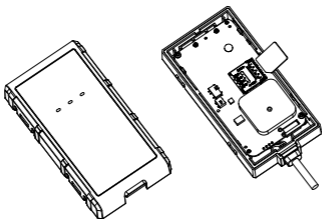

4. To ensure waterproof take effect, make sure the silicon rubber ring is installed in place.

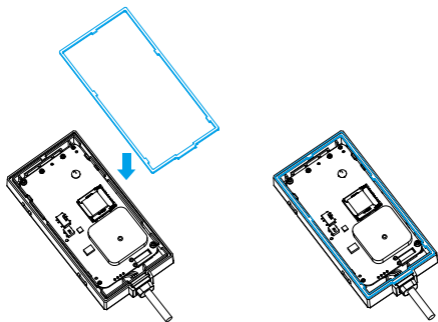

5. Press the upper case down and make sure all 5 clips are completely in place.

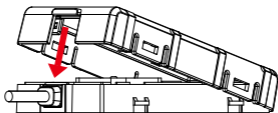

LED Indication

Power Status (Red)

On for 0.3s and off for 0.3s	Low power
On for 1s and off for 3s	Fully charged
On for 0.1s and off for 3s	Working normally
Solid on	Charging (Higher priority than the status of low power)
Off	Battery is exhausted/Internal failure

GNSS Status (Blue)

On for 0.3s and off for 0.3s	Searching GNSS signal
Solid on	Positioned
Off	GNSS module is in sleep mode or not working

Cellular Status (Green)

On for 0.3s and off for 0.3s	Network initializing
On for 1s and off for 3s	Receiving signal normally
On for 0.1s and off for 3s	Network connected
Solid on	Calling
Off	No signal received/No SIM card detected

Power supply Status (Red, Blue, Green)

Red, Blue and Green on for 3s Connected/disconnected power supply

Interfaces

6 Pin Standard Version

Interface	Color	Description
V+	Red	Power + (9-90V)
V-	Black	Power - Ground pin
ACC	Orange	Vehicle ignition detection
Relay	Yellow	Cut-off vehicle fuel supply
SOS+	Purple	SOS Trigger Pin
SOS-	White	SOS Ground Pin

6 Pin RS485/TTL Version (Optional)

Interface	Color	Description
V+	Red	Power + (9-90V)
V-	Black	Power - Ground Pin
Tx/RS485 A	Blue	TTL Tx or RS485 A
Rx/RS485 B	Green	TTL Rx or RS485 B
SOS+	Purple	SOS Trigger Pin
SOS-	White	SOS Ground Pin

Wiring of Standard Version

Tips for finding right wires:

1. Use multimeter to find out the positive and negative sides of vehicle battery.
Note: No matter the ignition key is switched to ON or OFF, current battery voltage can be shown in the multimeter.
2. The way to find ACC wire: Connect multimeter's black probe to negative side, and connect red probe to a random wire, at this moment, the voltage shown in multimeter is 0V; turn the key to ON, if the supply voltage is shown, that's the correct ACC wire.
3. Connect the two connectors together, if the vehicle has no connector, please connect device's wires to corresponding vehicle wires.

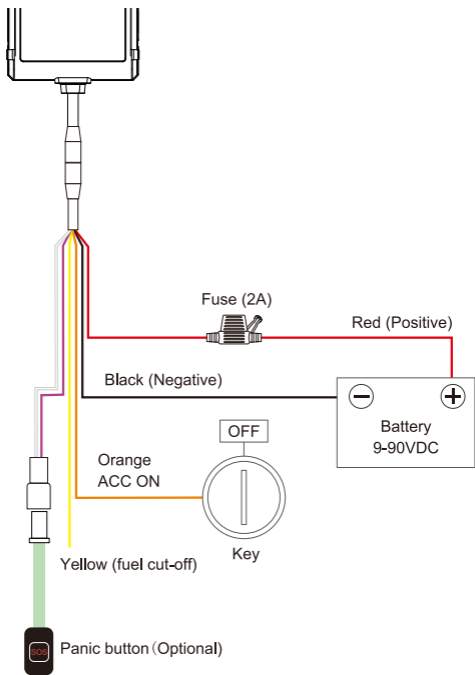

Installation recommendation

Please install the device under the guidance of professional personnel.

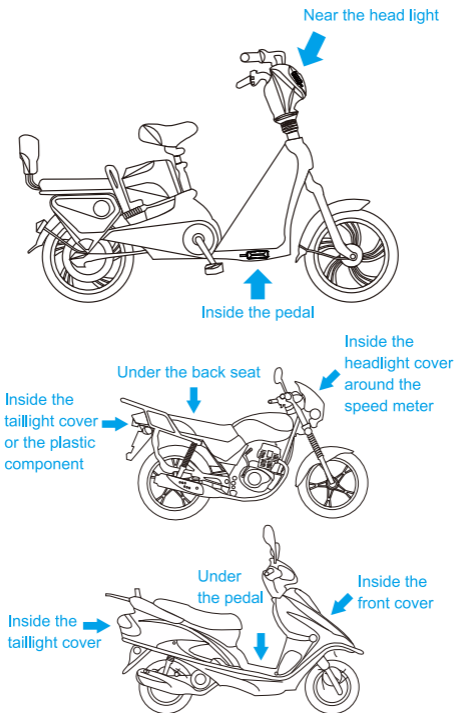

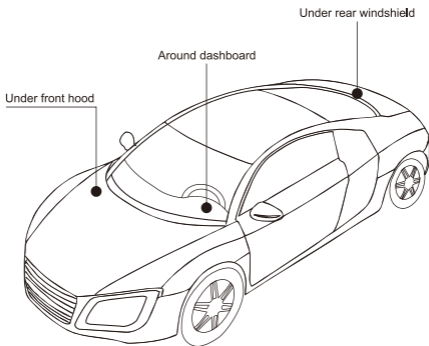

Note:

1. The device should face up to sky.
2. Metal thermal barrier or heating layer, which are always installed on windshield, may affect the signal, please avoid installing the device under these objects.

Platform & APP

1. Login service platform
Please login the designated service platform to set and operate the device.
2. Download APP
Please download and install the APP in designated website, APP store or Google Play store.

SMS Commands

VERSION#	Query the firmware version
----------	----------------------------------

STATUS#	Query the status
---------	---------------------

PARAM#	Query parameters (IMEI, SOS numbers, center number, and time zone)
--------	---

WHERE#	Query the current location
--------	----------------------------------

URL#	Query the location link	URL# Network connected and position fixed: <05-22 10:53> http://maps.google.com/maps? q=N23.111712,E114.409264 Network not connected but position fixed: <05-2210:53> http://maps.google.com/maps? q=N23.111712,E114.409264 Network not connected and position not fixed: NO DATA!
------	----------------------------	--

GPRSSET#	Query network parameters (GPRS status, APN, server address, URL, etc.)	GPRSSET# GPRS,ON;Currently use APN:CMnet,,;APN Auto set:OFF; SERVER,1,test.topstargps.com, 11139;URL, http://maps.google.com/maps?q=
APN#	Set APN parameters	APN, apnname# OR APN, apnname,user,pwd# Close automatic APN and set by yourself. APN# Check the current APN parameters.
SERVER#	Set the parameters of the monitoring server	SERVER,mode,domainName/IP, port,protocol# eg:SERVER,1,www.ydpat.com, 8011,0# SERVER,0,211.154.135.113, 8011,0# mode = 1 means set with domain name mode = 0 means set with ip address protocol = 0 means connect server with TCP protocol protocol = 1 means connect server with UDP protocol SERVER# Check the current sever parameters

SOS#	Set SOS numbers	<p>SOS,A,phone number 1,phone number 2,phone number 3# Add SOS phone number. SOS,D,sequence number 1, sequence number 2,sequence number 3# Delete the phone number according to the sequence number. SOS,D,phone number# Delete the matching SOS phone number. SOS# Check the SOS phone number.</p>
TIMER#	Set the time interval for the GNSS module to send data	<p>TIMER,T1,T2# T1=5~18000 or 0, upload interval when ACC ON, unit: seconds; 0 means no upload; default is 10; T2=5~18000 or 0, upload interval when ACC OFF,unit: seconds; 0 means no upload; default is 10. TIMER# Check the current parameters of T1 and T2.</p>
RELAY#	Control the power and fuel	<p>RELAY,A# A=0/1;0 means connection, 1 means cut off;default: 0. RELAY# Check the status of the control.</p>

ADT#	Set parameters to upload voltage values of the external battery	<p>ADT,A,T# A=ON/OFF, On/Off ADC data upload,default: Off B=5~3600, Default: 600s; Upload time interval,unit: seconds ADT,OFF# Turn off analog data upload ADT# Query the ADT port parameters</p>
RESET#	The device restarts 20 seconds later after receiving the command.	<p>RESET# The device would reboot in 20S after receiving the command.</p>
SPEEDCHECK#	Set and query the sudden speed change alert	<p>SPEEDCHECK,ON,M,T,A,D# M=0/1,alarm reporting method, 0: only GPRS, 1: GPRS+SMS,default: 0 T=1~30, detection duration, unit: seconds, default: 4 A=10~300(km/h),threshold of Harsh acceleration speed difference, default 30 D=10~300(km/h),difference threshold for sudden brake deceleration speed, default 50 SPEEDCHECK,OFF# Turn off the SPEEDCHECK alarm SPEEDCHECK# Query the SPEEDCHECK port parameters</p>

SWERVE#	Set and query the sharp cornering alert	<p>SWERVE,ON,M,A,S,T# M=0/1,alarm reporting method, 0: only GPRS, 1: GPRS+SMS, default: 0 A=10~180(degrees),trigger alarm Angle threshold, default 30 S=10~200(km/h),trigger alarm Speed threshold, default 60 T=1~30 detection duration, unit: seconds, default 3 SWERVE,OFF# Turn off the SWERVE alarm SWERVE# Query the SWERVE port parameters</p>
PULLALM#	Set tamper alert	<p>PULLALM,ON,M,N,T# M=0/1,alarm reporting method, 0: only GPRS, 1: GPRS+SMS, default: 0 N=1~40, Threshold of mean change, unit:0.1g g:acceleration of gravity, default 30 T=2~10 The time interval between power cut-off event (triggered before rollover) and rollover event, unit: seconds, default 5 PULLALM,OFF# Turn off the PULLALM alarm PULLALM# Query the PULLALM port parameters</p>

Troubleshooting

Type	Use
Unable to connect to tracking platform	Check the APN and IP settings. Check whether the data service of SIM card is enabled. Check the balance of SIM card.
Tracker shows offline	Check whether external power is still connected. Check if the vehicle entered network blind area. Check the balance of SIM card.
Unable to locate	Make sure the top side facing upward without metallic things shielded. Make sure it's not in area with no satellite coverage.
Location drift	In area with poor GNSS signal(tall building around or basement), drifting may happen. Check whether vibration happens around to trigger the accelerator.
No command reply	Make sure command format is correct. Vehicle may be in network blind area. Make sure SIM card is well inserted and have SMS service.

Warranty instructions

1. The warranty is valid only when the warranty card is properly completed, and upon presentation of the proof of purchase consisting of original invoice indicating the date of purchase, model and serial No. of the product. We reserve the right to refuse warranty if this information has been removed or changed after the original purchase of the product from the dealer.
2. Our obligations are limited to repair of the defect or replacement the defective part or at its discretion replacement of the product itself.
3. Warranty repairs must be carried out by our Authorized Service Centre. Warranty cover will be void, even if a repair has been attempted by any unauthorized service centre.
4. Repair or replacement under the terms of this warranty does not provide right to extension or renewal of the warranty period.
5. The warranty is not applicable to cases other than defects in material, design and workmanship.

Maintenance Record

Date		Service by	
Product Model			
IMEI Number			
Failure Description			
Comments			

