

dji MAVIC 3E / 3T

User Manual v1.0 2022.09

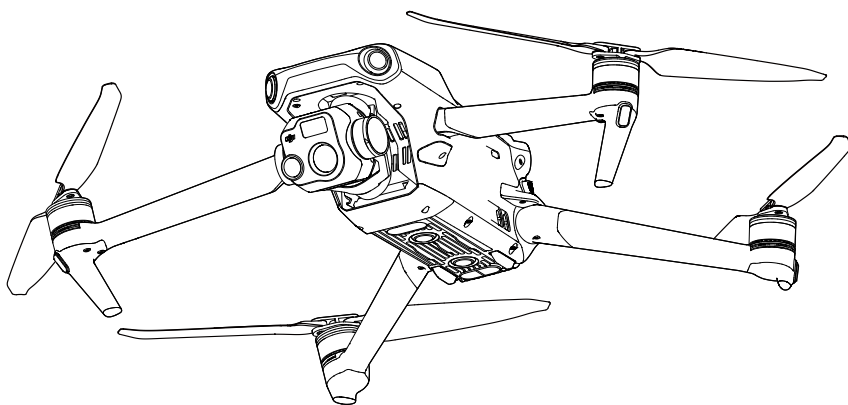



This document is copyrighted by DJI with all rights reserved. Unless otherwise authorized by DJI, you are not eligible to use or allow others to use the document or any part of the document by reproducing, transferring or selling the document. Users should only refer to this document and the content thereof as instructions to operate DJI UAV. The document should not be used for other purposes.

Searching for Keywords

Search for keywords such as “battery” and “install” to find a topic. If you are using Adobe Acrobat Reader to read this document, press Ctrl+F on Windows or Command+F on Mac to begin a search.

Navigating to a Topic

View a complete list of topics in the table of contents. Click on a topic to navigate to that section.

Printing this Document

This document supports high resolution printing.

Using this Manual

Legend

⚠ Warning

⚠ Important

💡 Hints and Tips

📖 Reference

Read Before the First Flight

DJI™ provides users with tutorial videos and the following documents.

1. In the Box
2. Safety Guidelines
3. Quick Start Guide
4. User Manual

It is recommended to watch all tutorial videos and read the safety guidelines before using for the first time. Prepare for your first flight by reviewing the quick start guide and refer to this user manual for more information.

Video Tutorials

Visit the link or scan the QR code below to watch the tutorial videos, which demonstrate how to use DJI MAVIC™ 3E/3T safely:



<https://www.dji.com/mavic-3-enterprise/video>

Download DJI Assistant 2

Download and install DJI ASSISTANT™ 2 (Enterprise Series) using the link below:

<https://www.dji.com/mavic-3-enterprise/downloads>

⚠ The operating temperature of this product is -10° to 40° C. It does not meet the standard operating temperature for military-grade application (-55° to 125° C), which is required to endure greater environmental variability. Operate the product appropriately and only for applications that meet the operating temperature range requirements of that grade.

Contents

Using this Manual	3
Legend	3
Read Before the First Flight	3
Video Tutorials	3
Download DJI Assistant 2	3
Product Profile	6
Introduction	6
Feature Highlights	6
Using for the First Time	7
Overview	10
Activation	12
Flight Safety	13
Flight Environment Requirements	13
Wireless Communication Requirements	13
Vision Systems and Infrared Sensing System	14
Return to Home	16
Flight Restrictions	23
DJI AirSense	27
Advanced Pilot Assistance Systems (APAS 5.0)	28
Pre-Flight Checklist	29
Starting/Stopping the Motors	30
Flight Test	31
Aircraft	32
Flight Modes	32
Aircraft Status Indicator	33
Beacon and Auxiliary Light	34
Flight Recorder	35
Propellers	35
Intelligent Flight Battery	36
Gimbal	42
Camera	43
PSDK Port	44
Remote Controller	47

Remote Controller System Interface	47
Remote Controller LEDs and Alerts	50
Operation	51
Optimal Transmission Zone	55
Linking the Remote Controller	55
Advanced Features	56
DJI Pilot 2 App	57
Homepage	57
Preflight Check	60
Camera View	61
Map View	69
Annotation Management and Synchronization	70
Flight Tasks	74
Health Management System (HMS)	77
DJI FlightHub 2	78
Appendix	79
Specifications	79
Firmware Update	86

Product Profile

Introduction

DJI Mavic 3E/3T features both an infrared sensing system and upward, downward, and horizontal omnidirectional vision systems, allowing for hovering and flying indoors as well as outdoors and for automatic Return to Home while avoiding obstacles in all directions. The aircraft has a maximum flight speed of 47 mph (75.6 kph) and a maximum flight time of 45 minutes.

The built-in DJI AirSense system detects nearby aircraft in the surrounding airspace, providing alerts in the DJI Pilot 2 app to ensure safety. Safety during flight is improved with the beacon that helps to identify the aircraft and the auxiliary bottom light allows the vision positioning system to achieve an even greater performance during takeoff and landing at night or when there is low light. The aircraft is also equipped with a PSDK port so users can broaden its applications.

The DJI RC Pro Enterprise remote controller has a built-in 5.5-in high brightness screen with a resolution of 1920×1080 pixels. Users can connect to the internet via Wi-Fi, while the Android operating system includes Bluetooth and GNSS. The DJI RC Pro Enterprise comes with a wide range of aircraft and gimbal controls as well as customizable buttons and has a maximum operating time of 3 hours.

Feature Highlights

Gimbal and Camera: DJI Mavic 3E's wide-angle 4/3 CMOS, 20MP sensor has a mechanical shutter to prevent motion blur and supports rapid 0.7-second interval shooting, improving the efficiency of mapping missions. Large 3.3 μm pixels that, together with Smart Low-Light Photo, offer significantly improved performance in dim conditions.

Both DJI Mavic 3E and DJI Mavic 3T are equipped with a 12MP tele camera, supporting up to 56× Max Hybrid Zoom to see essential details from afar.

Mavic 3T's thermal camera has 640×512 resolution and supports point and area temperature measurement, high-temperature alerts, color palettes, and isotherms to help you find your targets and make quick decisions. Mavic 3T's thermal and tele cameras support 28× continuous side-by-side zoom for easy comparisons.

Video Transmission: with four antennas and DJI's long-range transmission O3 Enterprise (OCUSYNC™ 3.0 Enterprise) technology, DJI Mavic 3E/3T offers a maximum transmission range of 15 km and video quality at up to 1080p 30fps from the aircraft to DJI Pilot 2 app. The remote controller works at both 2.4 and 5.8 GHz, and is capable of selecting the best transmission channel automatically.

Intelligent Flight Modes: the user can focus on operating the aircraft while the Advanced Pilot Assistance System 5.0 (APAS 5.0) helps the aircraft avoid obstacles in all directions.

Live Annotations: users can add PinPoints, lines, and areas in the map view of the remote controller and DJI FlightHub 2. Share annotation data to other devices logged in to DJI FlightHub 2. Data is shared in real time, which facilitates operations across the air and ground.

AR Projection: DJI Pilot 2 supports the projection of Home Point, PinPoint, and Waypoint locations in the camera view, providing users with clear flight targets and better situational awareness.

Cloud-based Mapping: when the remote controller is logged in to DJI FlightHub 2, the aircraft can perform a cloud mapping task, which enables viewing of and generating a map on DJI FlightHub 2 simultaneously.

- ☀️ • The major difference between the DJI Mavic 3E and DJI Mavic 3T is the gimbal and camera. The general descriptions in this manual apply to both Mavic 3E and Mavic 3T. The illustration takes Mavic 3T as an example.
 - For more details, refer to the DJI FlightHub 2 User Guide, which is available to download from the official DJI website <https://www.dji.com/flighthub-2/downloads>.
-
- ⚠️ • The maximum flight time was tested in an environment without wind while flying at a consistent flight speed of 20.1 mph (32.4 kph). The maximum flight speed was tested at sea level altitude without wind. Note that the maximum flight speed is limited to 42 mph (68.4 kph) in the European Union (EU). These values are for reference only.
 - The remote control devices reach their maximum transmission distance (FCC) in a wide-open area with no electromagnetic interference at an altitude of about 120 m (400 ft). The maximum transmission distance refers to the maximum distance that the aircraft can still send and receive transmissions. It does not refer to the maximum distance the aircraft can fly in a single flight. The maximum runtime was tested in a laboratory environment. This value is for reference only.
 - 5.8 GHz is not supported in certain regions. Observe local laws and regulations.

Using for the First Time

DJI Mavic 3E/3T is folded before being packaged. Follow the steps below to unfold the aircraft and remote controller.

Preparing the Aircraft

1. All Intelligent Flight Batteries are in hibernation mode before shipment to ensure safety. Use the provided charger to charge and activate the Intelligent Flight Batteries for the first time. It takes approximately 1 hour and 20 minutes to fully charge an Intelligent Flight Battery.

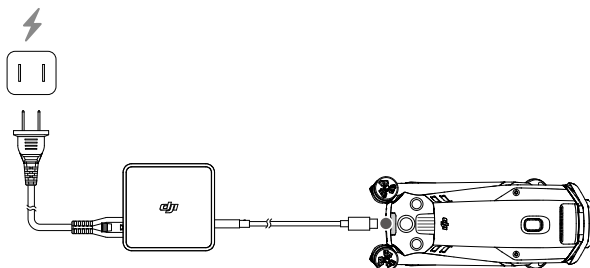

2. Unfold the front arms before unfolding the rear arms.

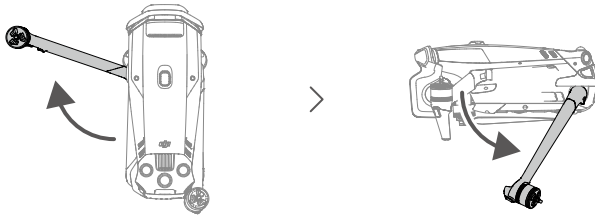

3. Remove the gimbal protector from the camera.

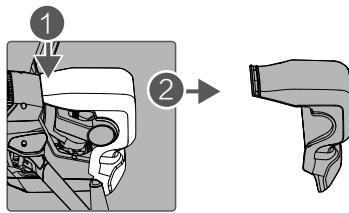

4. Attaching the propellers.

Propellers with and without marks indicate different directions of rotation. Attach the propellers with marks to the motors with marks and the unmarked propellers to the motors without marks. Hold the motor, press the propeller down, and rotate in the direction marked on the propeller until it pops up and locks in place. Unfold the propeller blades.

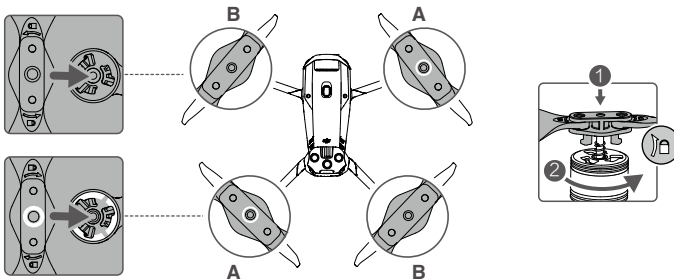

- ⚠ • Make sure to unfold the front arms before unfolding the rear arms.
- Make sure the gimbal protector is removed and all arms are unfolded before powering on the aircraft. Otherwise, it may affect the aircraft self-diagnostics.
- Attach the gimbal protector when the aircraft is not in use. Adjust the camera to the horizontal position, then cover the vision system with the gimbal protector. Note, align the positioning holes, and then press the buckle to complete the installation.

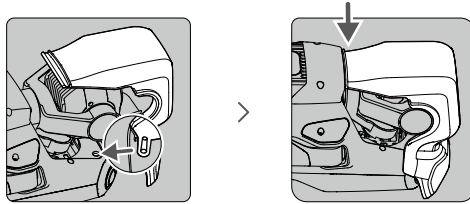

Preparing the Remote Controller

1. Use the provided charger to charge the remote controller via the USB-C port to activate the battery.

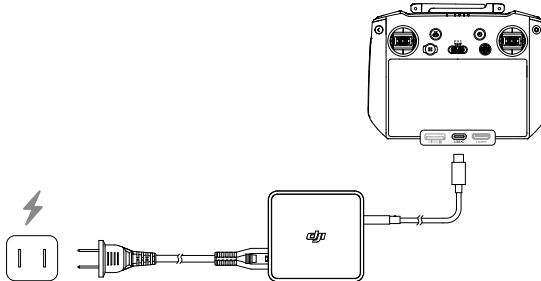

2. Remove the control sticks from the storage slots on the remote controller and screw them into place.
3. Unfold the antennas.

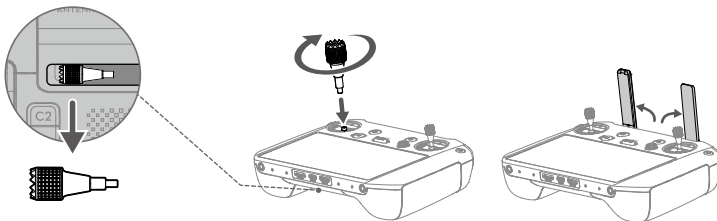

Overview

Aircraft

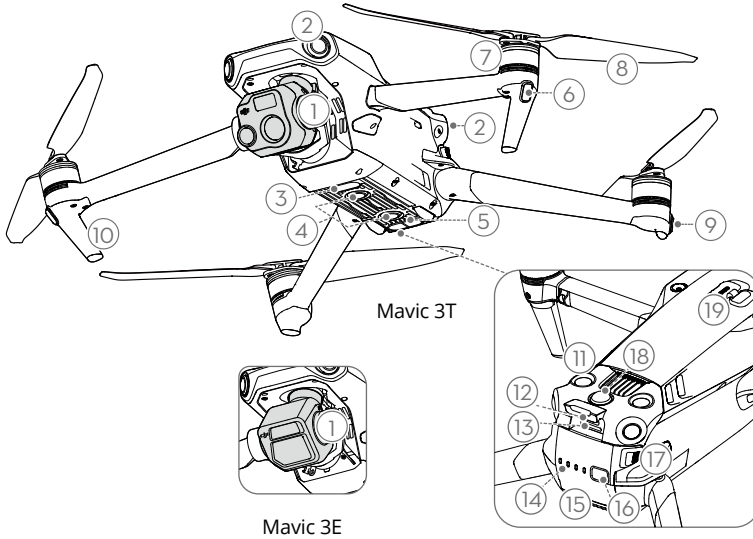

1. Gimbal and Camera
2. Horizontal Omnidirectional Vision System
3. Auxiliary Bottom Light
4. Downward Vision System
5. Infrared Sensing System
6. Front LEDs
7. Motors
8. Propellers
9. Aircraft Status Indicators
10. Landing Gears (Built-in antennas)
11. Upward Vision System
12. USB-C Port
13. microSD Card Slot
14. Battery Level LEDs
15. Intelligent Flight Battery
16. Power Button
17. Battery Buckles
18. Beacon
19. PSDK Port

Remote Controller

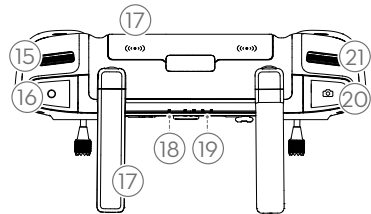
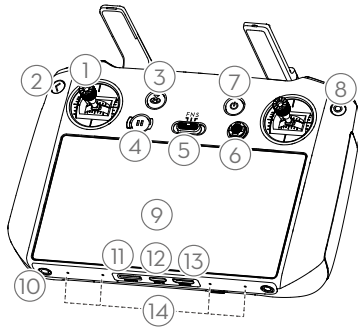

1. Control Sticks

Use the control sticks to control the aircraft movements. Set the flight control mode in DJI Pilot 2. The control sticks are removable and easy to store.

2. Back/Function Button

Press once to return to the previous screen. Press twice to return to the homepage.

Use the back button and another button to activate button combinations. Refer to the Remote Controller Button Combinations section for more information.

3. RTH Button

Press and hold to initiate RTH. Press again to cancel RTH.

4. Flight Pause Button

Press once to make the aircraft brake and hover in place (only when GNSS or Vision Systems are available).

5. Flight Mode Switch

For switching between three flight modes: N-mode (Normal), S-mode (Sport), and F-mode (Function). F-mode can be set to A-mode (Attitude) or T-mode (Tripod) in DJI Pilot 2.

6. 5D Button

View the default 5D button functions in DJI

Pilot 2. Refer to Guide on the homepage for more information.

7. Power Button

Press once to check the current battery level. Press, and then press and hold to power the remote controller on or off. When the remote controller is powered on, press once to turn the touchscreen on or off.

8. Confirm Button

Press once to confirm a selection. The button does not have a function when using DJI Pilot 2.

9. Touchscreen

Touch the screen to operate the remote controller. Note that the touchscreen is not waterproof. Operate with caution.

10. M4 Screw Hole

11. microSD Card Slot

For inserting a microSD card.

12. USB-C Port

For charging.

13. Mini HDMI Port

For outputting HDMI signal to an external monitor.

14. Microphone

15. Gimbal Dial

Controls the tilt of the camera.

16. Record Button

Press once to start or stop recording.

17. Antennas

Transmit control and video wireless signals between the remote controller and the aircraft. It includes external and built-in antennas. Do not block the antennas to avoid affecting the transmission performance.

18. Status LED

Indicates the status of the remote controller.

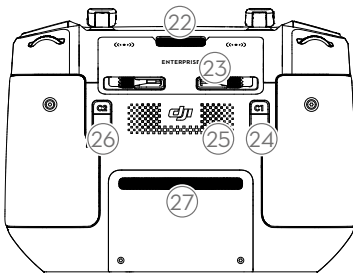

19. Battery Level LEDs

Display the current battery level of the remote controller.

20. Focus/Shutter Button

Press halfway down on the button to autofocus and press all the way down to take a photo.

21. Camera Settings Dial

For zoom control.

23. Control Sticks Storage Slot

For storing the control sticks.

24. Customizable C1 Button

Use to switch the wide and zoom screen by default. The functions can be customized in DJI Pilot 2.

25. Speaker

26. Customizable C2 Button

Use to switch the map and camera view by default. The functions can be customized in DJI Pilot 2.

27. Air Intake

For heat dissipation. Do not block the air intake during usage.

22. Air Vent

For heat dissipation. Do not block the air vent during usage.

Activation

The aircraft and remote controller require activation before using for the first time. Press, and then press again and hold the power button to power on the devices. Follow the on-screen prompts to activate. Ensure that the remote controller can access the internet during activation.

 Make sure that the aircraft is linked to the remote controller before activation. The devices are linked by default. If linking is needed, refer to the Remote Controller Linking section for more details.

 Check the internet connection if the activation fails. Make sure internet access is available and try activating the remote controller again. Contact DJI Support if the activation fails multiple times.

Flight Safety

Make sure to have training and practice before operating any actual flight. Practice with the simulator in DJI Assistant 2 or fly under the guidance of experienced professionals. Pick a suitable area to fly in according to the following flight requirements and restrictions. Fly the aircraft below 120 m (400 ft). Any flight altitude higher than that may violate local laws and regulations. Make sure you understand and comply with the local laws and regulations before flying. Read the Safety Guidelines carefully to understand all safety precautions before flying.

Flight Environment Requirements

1. DO NOT operate the aircraft in severe weather conditions, including wind speeds exceeding 12 m/s, snow, rain, and fog.
2. Only fly in open areas. Tall buildings and large metal structures may affect the accuracy of the onboard compass and GNSS system. It is recommended to keep the aircraft at least 5 m away from structures.
3. Avoid obstacles, crowds, trees, and bodies of water (recommended height is at least 3 m above water).
4. Minimize interference by avoiding areas with high levels of electromagnetism, such as locations near power lines, base stations, electrical substations, and broadcasting towers.
5. DO NOT take off from an altitude more than 6,000 m (19,685 ft) above sea level. The performance of the aircraft and its battery is limited when flying at high altitudes. Fly with caution.
6. GNSS cannot be used on the aircraft in polar regions. Use the vision system instead.
7. DO NOT take off from moving objects, such as cars and ships.
8. Make sure the beacon and the auxiliary bottom light are enabled at night for flight safety.
9. To avoid affecting the motor service life, DO NOT take off or land the aircraft on sandy or dusty areas.

Wireless Communication Requirements

1. Fly in wide open areas. Tall buildings, steel structures, mountains, rocks, or tall trees may affect the accuracy of the GNSS and block the video transmission signal.
2. Avoid interference between the remote controller and other wireless equipment. Make sure to power off nearby Wi-Fi and Bluetooth devices when controlling the aircraft by remote control.
3. Be extremely alert when flying near areas with magnetic or radio interference. Pay close attention to the image transmission quality and signal strength on DJI Pilot 2. Sources of electromagnetic interference include but are not limited to: high voltage lines, large-

scale power transmission stations or mobile base stations, and broadcasting towers. The aircraft may behave abnormally or lose control when flying in areas with too much interference. Return to the Home Point and land the aircraft if prompted to do so in DJI Pilot 2.

Vision Systems and Infrared Sensing System

DJI Mavic 3E/3T is equipped with both an Infrared Sensing System and Horizontal Omnidirectional (Forward, Backward, Lateral), Upward, and Downward Vision Systems.

The Upward and Downward Vision Systems consist of two cameras each, and the Forward, Backward, and Lateral Vision Systems consist of four cameras in total.

The Infrared Sensing System consists of two 3D infrared modules. The Downward Vision System and Infrared Sensing System help the aircraft maintain its current position, hover more precisely, and fly indoors or in other environments where GNSS is unavailable.

In addition, the Auxiliary Bottom Light located on the underside of the aircraft improves visibility for the Downward Vision System in weak light conditions.

Horizontal Omnidirectional Vision System

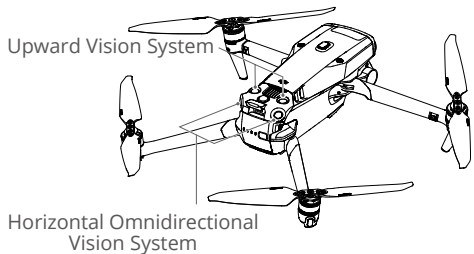
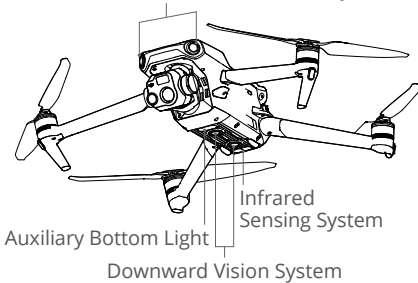

Detection Range

Forward Vision System

Precision Measurement Range: 0.5-20 m; FOV: 90° (horizontal), 103° (vertical)

Backward Vision System

Precision Measurement Range: 0.5-16 m; FOV: 90° (horizontal), 103° (vertical)

Lateral Vision System

Precision Measurement Range: 0.5-25 m; FOV: 90° (horizontal), 85° (vertical)

Upward Vision System

Precision Measurement Range: 0.2-10 m; FOV: 100° (front and back), 90° (left and right)

Downward Vision System

Precision Measurement Range: 0.3-18 m; FOV: 130° (front and back), 160° (left and right).

The Downward Vision System works best when the aircraft is at an altitude of 0.5 to 30 m.

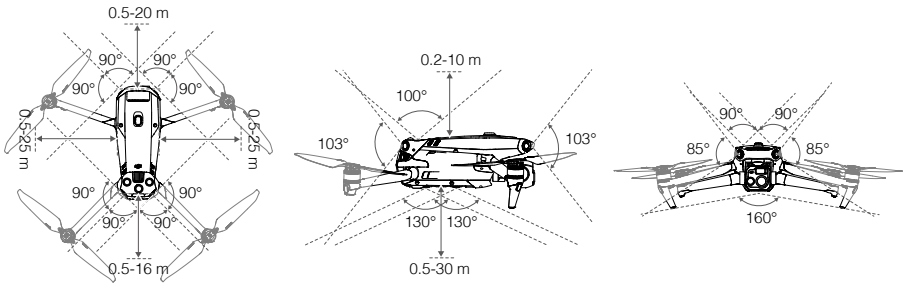

Using the Vision System

The positioning function of the Downward Vision System is applicable when GNSS signals are unavailable or weak. It is automatically enabled in Normal mode.

The Horizontal Omnidirectional and Upward Vision Systems will activate automatically when the aircraft is powered on if the aircraft is in Normal mode and Obstacle Avoidance is set to Avoid or Brake in DJI Pilot 2. The aircraft can actively brake when detecting obstacles when using the Horizontal Omnidirectional, and Upward Vision Systems. The Horizontal Omnidirectional and Upward Vision Systems work best with adequate lighting and clearly marked or textured obstacles. Due to inertia, users must make sure to brake the aircraft within a reasonable distance.



- ⚠ • Pay attention to the flight environment. The Vision Systems and Infrared Sensing System only work in certain scenarios and cannot replace human control and judgment. During a flight, always pay attention to the surrounding environment and the warnings on DJI Pilot 2, and be responsible for and maintain control of the aircraft at all times.
- The Downward Vision System works best when the aircraft is at an altitude from 0.5 to 30 m if there is no GNSS available. Extra caution is required if the altitude of the aircraft is above 30 m as the vision positioning performance may be affected.
- The Auxiliary Bottom Light can be set in DJI Pilot 2. If set to Auto, it is automatically enabled when the environment light is too weak. Note: the Vision System camera performance may be affected. Fly with caution if the GNSS signal is weak.
- The Downward Vision System may not function properly when the aircraft is flying over water. Therefore, the aircraft may not be able to actively avoid the water below when landing. It is recommended to maintain flight control at all times, make reasonable judgments based on the surrounding environment, and avoid over-relying on the Downward Vision System.
- The vision system cannot work properly over surfaces without clear pattern variations or where the light is too weak or too strong. The vision system cannot work properly in the following situations:
 - a. Flying over monochrome surfaces (e.g., pure black, white, red, or green).
 - b. Flying over highly reflective surfaces.
 - c. Flying over water or transparent surfaces.



- d. Flying over moving surfaces or objects.
- e. Flying in an area with frequent and drastic lighting changes.
- f. Flying over extremely dark (< 10 lux) or bright (> 40,000 lux) surfaces.
- g. Flying over surfaces that strongly reflect or absorb infrared waves (e.g., mirrors).
- h. Flying over surfaces without clear patterns or texture.
- i. Flying over surfaces with repeating identical patterns or textures (e.g., tiles with the same design).
- j. Flying over obstacles with small surface areas (e.g., tree branches).
- Keep the sensors clean at all times. DO NOT scratch or tamper with the sensors. DO NOT use the aircraft in dusty or humid environments.
- DO NOT fly when it is rainy, smoggy, or the visibility is lower than 100 m.
- Check the following each time before takeoff:
 - a. Make sure there are no stickers or any other obstructions over the glass of the Vision Systems and Infrared Sensing system.
 - b. Use soft cloth if there is any dirt, dust, or water on the glass of the Vision Systems and Infrared Sensing system. DO NOT use any cleaning product that contains alcohol.
 - c. Contact DJI Support if there is any damage to the glass of the Infrared Sensing and Vision Systems.
- DO NOT obstruct the Infrared Sensing System.

Return to Home

Return to Home (RTH) brings the aircraft back to the last recorded Home Point when the positioning system is functioning normally. There are three types of RTH: Smart RTH, Low Battery RTH, and Failsafe RTH. The aircraft automatically flies back to the Home Point and lands when Smart RTH is initiated, the aircraft enters Low Battery RTH, or the signal between the remote controller and the aircraft is lost during flight.

	GNSS	Description
Home Point	 10	The first location where the aircraft receives a strong to moderately strong GNSS signal (indicated by a white icon) will be recorded as the default Home Point. The Home Point can be updated before takeoff as long as the aircraft receives another strong to moderately strong GNSS signal. If the signal is weak, the Home Point will not be updated. DJI Pilot 2 will give a voice prompt when the Home Point is set.

Smart RTH

Press and hold the RTH button on the remote controller to initiate Smart RTH. Press the RTH button or flight pause button to exit Smart RTH and regain full control of the aircraft.

Advanced RTH

Advanced RTH is enabled if the lighting is sufficient and the environment is suitable for vision systems when Smart RTH is triggered. The aircraft will automatically plan the best RTH path, which will be displayed in DJI Pilot 2 and will adjust according to the environment.

RTH Settings

RTH settings are available for Advanced RTH. Go to the camera view in DJI Pilot 2, tap **•••**-> , and then RTH.

1. **Preset:** if the aircraft is further than 50 m from the home point when RTH begins, the aircraft will plan the RTH path, fly to an open area while avoiding obstacles, ascend to the RTH Altitude, and return to home using the best path.
If the aircraft is at a distance of 5 to 50 m from the home point when RTH begins, the aircraft will not ascend to the RTH Altitude and instead return to home using the best path at the current altitude.
When the aircraft is near the home point, the aircraft will descend while flying forward if the current altitude is higher than the RTH Altitude.
2. **Optimal:** regardless of the RTH Altitude settings, the aircraft automatically plans the optimal RTH path and adjusts the altitude according to environmental factors such as obstacles and transmission signals. The optimal RTH path means the aircraft will travel the shortest distance possible, reducing the amount of battery power used and increasing flight time.

Advanced RTH Procedure

1. The Home Point is recorded automatically.
2. Advanced RTH is triggered.
3. The aircraft brakes and hover in place.
 - a. The aircraft lands immediately if it is less than 5 m from the Home Point when RTH begins.
 - b. If the aircraft is farther than 5 m from the home point when RTH begins, the aircraft will plan the best path according to the RTH settings and fly to the Home Point while avoiding obstacles and GEO zones. The aircraft front will always point in the same direction as the flight direction.
4. The aircraft will fly automatically according to the RTH settings, environment, and transmission signal during RTH.
5. The aircraft lands and the motors stop after reaching the Home Point.

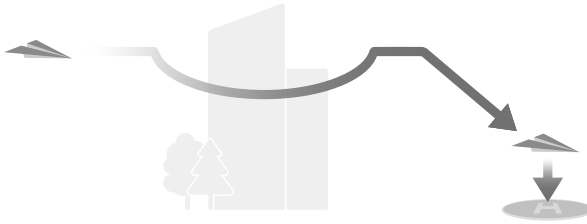

Straight Line RTH

The aircraft will enter Straight Line RTH when the lighting is not sufficient and the environment is not suitable for the Advanced RTH.

Straight Line RTH Procedure:

1. The Home Point is recorded.
2. Straight Line RTH is triggered.
3. The aircraft brakes and hovers in place.
 - a. If the aircraft is farther than 50 m from the Home Point when RTH begins, the aircraft first ascends to a height of 20 m (this step will be skipped if the current height is higher than 20 m), then the aircraft adjusts its orientation and ascends to the preset RTH altitude and flies to the Home Point. If the current altitude is higher than the RTH altitude, the aircraft will fly to the Home Point at the current altitude.
 - b. If the aircraft is at a distance of 5 to 50 m from the Home Point when RTH begins, the aircraft adjusts its orientation and flies to the Home Point at the current altitude. If the current altitude is lower than 2 m when RTH begins, the aircraft will ascend to 2 m and flies back to the Home Point.
 - c. The aircraft lands immediately if it is less than 5 m from the Home Point when RTH begins.
4. The aircraft lands and the motors stop after reaching the Home Point.



- During Advanced RTH, the aircraft will adjust the flight speed automatically to environmental factors such as wind speed and obstacles.
 - The aircraft cannot avoid small or fine objects such as tree branches or power lines. Fly the aircraft to an open area before using Smart RTH.
 - Set Advanced RTH as Preset if there are power lines or towers that the aircraft cannot avoid on the RTH path and make sure the RTH Altitude is set higher than all obstacles.
 - The aircraft will brake and return to home according to the latest settings if the RTH settings are changed during RTH.
 - If the max altitude is set below the current altitude during RTH, the aircraft will descend to the max altitude and return to home.
 - The RTH Altitude cannot be changed during RTH.
-



- If there is a large difference in the current altitude and the RTH altitude, the amount of battery power used cannot be calculated accurately due to wind speeds at different altitudes. Pay extra attention to the battery power and warning prompts in DJI Pilot 2.
 - Advanced RTH will not be available if the lighting condition and environment are not suitable for vision systems during takeoff or RTH.
 - During Advanced RTH, the aircraft will enter Straight Line RTH if the lighting condition and environment are not suitable for vision systems and the aircraft cannot avoid obstacles. An appropriate RTH altitude must be set before entering RTH.
 - When the remote controller signal is normal during Advanced RTH, the pitch stick can be used to control the flight speed, but the orientation and altitude cannot be controlled and the aircraft cannot be flown left or right. Acceleration uses more power. The aircraft cannot avoid obstacles if the flight speed exceeds the effective sensing speed. The aircraft will brake and hover in place and exit from RTH if the pitch stick is pulled all the way down. The aircraft can be controlled after the pitch stick is released.
 - When the remote controller signal is normal during Straight Line RTH, the flight speed and altitude can be controlled using the remote controller, but the orientation of the aircraft cannot be controlled and the aircraft cannot be flown left or right. The aircraft cannot avoid obstacles if the pitch stick is used to accelerate and the flight speed exceeds the effective sensing speed. When the aircraft is ascending or flying forward, push the control stick completely in the opposite direction to exit RTH. Release the control stick to regain control of the aircraft.
 - If the aircraft reaches the max altitude while it is ascending during RTH, the aircraft stops and returns to the Home Point at the current altitude.
 - The aircraft will hover in place if it reaches the max altitude while it is ascending after detecting obstacles in front.
-

Low Battery RTH

When the Intelligent Flight Battery level is too low and there is not enough power to return home, land the aircraft as soon as possible.

To avoid unnecessary danger caused by insufficient power, the aircraft will automatically calculate if it has enough power to fly to the Home Point from its current location. A warning prompt will appear in DJI Pilot 2 when the battery level is low and the aircraft can only support Low Battery RTH.

The aircraft will automatically fly to the Home Point if no action is taken after a 10-second countdown. Cancel RTH by pressing the RTH button or flight pause button on the remote controller.

A low battery level warning will be prompted only once during a flight. If RTH is canceled following the warning, the Intelligent Flight Battery may not have enough power for the aircraft to land safely, which may lead to the aircraft crashing or being lost.

The aircraft will land automatically if the current battery level can only support the aircraft long enough to descend from its current altitude. Auto landing cannot be canceled but the remote controller can be used to alter the horizontal movement and the speed of descent of the aircraft during landing. If there is sufficient power, the throttle stick can be used to make the aircraft ascend at a speed of 1 m/s.

During auto landing, move the aircraft horizontally to find an appropriate place to land as soon as possible. The aircraft will fall if the user keeps pushing the throttle stick upward until the power is depleted.

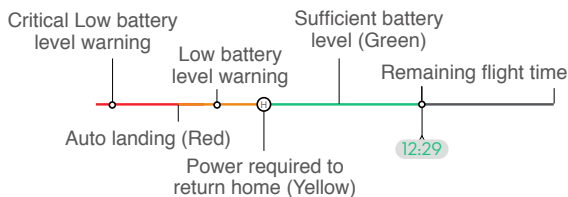

Battery Level Indicator

Battery Level Warning	Implication	Flight
Low Battery RTH	The remaining battery level is only enough for the aircraft to fly to the Home Point safely.	If RTH is selected, the aircraft will fly to the Home Point automatically and landing protection will be enabled. Users can regain control of the aircraft and land it manually during RTH. ⚠ The warning will not appear again after choosing not to use RTH. Decide carefully and ensure flight safety.
Auto Landing	The remaining battery level is only enough for the aircraft to descend from its current altitude.	The aircraft will land automatically and landing protection will be enabled.
Estimated Remaining Flight Time	The estimated remaining flight time of the aircraft is based on its current battery level.	/
Low Battery Level Warning	Tap ●●●-> 📷 in camera view to set the low battery level threshold value.*	Long beeps will sound from the remote controller. The user can still control the aircraft.
Critical Low Battery Level Warning	Tap ●●●-> 📷 in camera view to set the critical low battery level threshold value.*	Short beeps will sound from the remote controller. The user can still control the aircraft. It is unsafe to continue flying the aircraft. Land immediately.

* The threshold value is different from that of Low Battery RTH or auto landing.

⚠ The colored zones and the estimated remaining flight time on the battery level indicator are automatically adjusted according to the aircraft's current location and status.

Failsafe RTH

The action of the aircraft when the remote controller signal is lost can be set to RTH, land, or hover in DJI Pilot 2. If the Home Point was successfully recorded and the compass is functioning normally, Failsafe RTH automatically activates after the remote controller signal is lost for more than six seconds.

When the lighting is sufficient and the vision systems are working normally, DJI Pilot 2 will display the RTH path that was generated by the aircraft before the remote controller signal was lost and return to home using Advanced RTH according to the RTH settings. The aircraft will remain in RTH even if the remote controller signal is restored. DJI Pilot 2 will update the RTH path accordingly.

When the lighting is not sufficient and the vision systems are not available, the aircraft will enter Original Route RTH.

Original Route RTH Procedure:

1. The aircraft brakes and hover in place.
2.
 - a. If the aircraft is farther than 50 m from the Home Point, the aircraft adjusts its orientation and flies backward for 50 m on its original flight route before entering Straight Line RTH.
 - b. If the aircraft is farther than 5 m but less than 50 m from the Home Point, it enters Straight Line RTH.
 - c. The aircraft lands immediately if it is less than 5 m from the Home Point when RTH begins.
3. The aircraft lands and the motors stop after reaching the Home Point.

The aircraft will enter or remain in Straight Line RTH if the remote controller signal is restored during RTH.



- The aircraft may not be able to return to the Home Point normally if the GNSS signal is weak or unavailable. The aircraft may enter ATTI mode if the GNSS signal becomes weak or unavailable after entering Failsafe RTH. The aircraft will hover in place for a while before landing.
 - It is important to set a suitable RTH altitude before each flight. Launch DJI Pilot 2 and set the RTH altitude. The default RTH altitude is 100 m.
 - The aircraft cannot avoid obstacles during Failsafe RTH if the vision systems are unavailable.
 - GEO zones may affect the RTH. Avoid flying near GEO zones.
 - The aircraft may not be able to return to a Home Point when the wind speed is too high. Fly with caution.
 - Be aware of small or fine objects (such as tree branches or power lines) or transparent objects (such as water or glass) during RTH. Exit RTH and control the aircraft manually in an emergency.
 - RTH may not be available in some environments even if the vision systems are working. The aircraft will exit RTH in such cases.
-

Landing Protection

Landing Protection will activate during Smart RTH. Landing Protection is enabled once the aircraft begins to land.

1. During Landing Protection, the aircraft will automatically detect and carefully land on suitable ground.
2. If the ground is determined unsuitable for landing, the aircraft will hover and wait for pilot confirmation.
3. If Landing Protection is not operational, DJI Pilot 2 will display a landing prompt when the aircraft descends to 0.5 m from the ground. Tap confirm or push the throttle stick all the way down and hold for one second, and the aircraft will land.



- Landing protection will not work in the following circumstances:
 - a. When the downward vision system is disabled.
 - b. When the user is operating the pitch/roll/throttle stick (landing protection will be re-activated when the control stick is not in use).
 - c. When the positioning system is not functioning properly (e.g., position drift errors).
 - d. When the vision system needs calibrating. When the lighting is too dim for the vision system to operate.
 - e. If no valid observation data is obtained and the ground conditions cannot be detected, the aircraft will descend to 0.5 m above the ground and hover pending confirmation by the user to land.
-

Precision Landing

The aircraft automatically scans and attempts to match the terrain features below during RTH. The aircraft will land when the current terrain matches the Home Point. A prompt will appear in DJI Pilot 2 if the terrain match fails.



- Landing Protection is activated during Precision Landing.
 - The performance of Precision Landing is subject to the following conditions:
 - a. The Home Point must be recorded upon takeoff and must not be changed during flight. Otherwise, the aircraft will have no record of the terrain features of the Home Point.
 - b. During takeoff, the aircraft must ascend at least 7 m before moving horizontally.
 - c. The Home Point terrain features must remain largely unchanged.
 - d. The terrain features of the Home Point must be sufficiently distinctive. Terrain such as a snow-covered field is not suitable.
 - e. The lighting conditions must not be too light or too dark.
 - The following actions are available during Precision Landing:
 - a. Press the throttle stick down to accelerate landing.
 - b. Move the control sticks in any direction apart from the throttle direction to stop Precision Landing. The aircraft will descend vertically after the control sticks are released.
-

Flight Restrictions

GEO (Geospatial Environment Online) System

DJI's Geospatial Environment Online (GEO) system is a global information system that provides real-time information on flight safety and restriction updates and prevents UAVs from flying in restricted airspace. Under exceptional circumstances, restricted areas can be unlocked to allow flight. Prior to that, the user must submit an unlocking request based on the current restriction level in the intended flight area. The GEO system may not fully comply with local laws and regulations. Users shall be responsible for their own flight safety and must consult with the local authorities on the relevant legal and regulatory requirements before requesting to unlock a flight in a restricted area.

GEO Zones

DJI's GEO system designates safe flight locations, provides risk levels and safety notices for individual flights and offers information on restricted airspace. All restricted flight areas are referred to as GEO Zones, which are further divided into Restricted Zones, Authorization Zones, Warning Zones, Enhanced Warning Zones, and Altitude Zones. Users can view such information in real-time in DJI Pilot 2. GEO Zones are specific flight areas, including but not limited to airports, large event venues, locations where public emergencies have occurred (such as forest fires), nuclear power plants, prisons, government properties, and military facilities.

By default, the GEO system limits takeoffs and flights in zones that may cause safety or security concerns. A GEO Zone map that contains comprehensive information on GEO Zones around the globe is available on the official DJI website: <https://www.dji.com/flysafe/geo-map>.

Flight Restrictions in GEO Zones

The following section describes in detail the flight restrictions for the above mentioned GEO Zones.

GEO Zone	Flight Restriction	Scenario
Restricted Zones (Red)	UAVs are prohibited from flying in Restricted Zones. If you have obtained permission to fly in a Restricted Zone, please visit https://www.dji.com/flysafe or contact flysafe@dji.com to unlock the zone.	Takeoff: the aircraft motors cannot be started in Restricted Zones.
		In Flight: when the aircraft flies inside a Restricted Zone, a 100-second countdown will commence in DJI Pilot 2. When the countdown is finished, the aircraft will land immediately in semi-automatic descent mode and turn off its motors after landing.
		In Flight: when the aircraft approaches the boundary of a Restricted Zone, the aircraft will automatically decelerate and hover.

<p>Authorization Zones (Blue)</p>	<p>The aircraft will not be able to take off in an Authorization Zone unless it obtains a permission to fly in the area.</p>	<p>Takeoff: the aircraft motors cannot be started in Authorization Zones. To fly in an Authorization Zone, the user is required to submit an unlocking request registered with a DJI-verified phone number.</p> <p>In Flight: when the aircraft flies inside an Authorization Zone, a 100-second countdown will commence in DJI Pilot 2. When the countdown is finished, the aircraft will land immediately in semi-automatic descent mode and turn off its motors after landing.</p>
<p>Warning Zones (Yellow)</p>	<p>A warning will be displayed when the aircraft flies inside a Warning Zone.</p>	<p>The aircraft can fly in the zone but the user is required to understand the warning.</p>
<p>Enhanced Warning Zones (Orange)</p>	<p>When the aircraft flies in an Enhanced Warning Zone, a warning will be displayed prompting the user to confirm the flight path.</p>	<p>The aircraft can continue to fly once the warning is confirmed.</p>
<p>Altitude Zones (Gray)</p>	<p>The aircraft altitude is limited when flying inside an Altitude Zone.</p>	<p>When the GNSS signal is strong, the aircraft cannot fly above the altitude limit.</p> <p>In Flight: when the GNSS signal changes from weak to strong, a 100-second countdown will commence in DJI Pilot 2 if the aircraft exceeds the altitude limit. When the countdown is finished, the aircraft will descend below the altitude limit and hover.</p> <p>When the aircraft approaches the boundary of an Altitude Zone and the GNSS signal is strong, the aircraft will decelerate automatically and hover if the aircraft is above the altitude limit.</p>



Semi-Automatic Descent: All stick commands except the throttle stick command and the RTH button are available during descent and landing. The aircraft motors will turn off automatically after landing. It is recommended to fly the aircraft to a safe location before the semi-automatic descent.

Buffer Zone

Buffer Zones for Restricted Zones/Authorization Zones: to prevent the aircraft from accidentally flying into a Restricted or Authorization Zone, the GEO system creates a buffer zone of about 20 meters wide outside each Restricted and Authorization Zone. As shown

in the illustration below, the aircraft can only take off and land away from the Restricted or Authorization Zone when inside the buffer zone. The aircraft cannot fly toward the Restricted or Authorization Zone unless an unlocking request has been approved. The aircraft cannot fly back into the buffer zone after leaving the buffer zone.

Buffer Zones for Altitude Zones: a buffer zone of about 20 meters wide is established outside each Altitude Zone. As shown in the illustration below, when approaching the buffer zone of an Altitude Zone in a horizontal direction, the aircraft will gradually reduce its flight speed and hover outside the buffer zone. When approaching the buffer zone from underneath in a vertical direction, the aircraft can ascend and descend in altitude or fly away from the Altitude Zone. The aircraft cannot fly toward the Altitude Zone. The aircraft cannot fly back into the buffer zone in a horizontal direction after leaving the buffer zone.

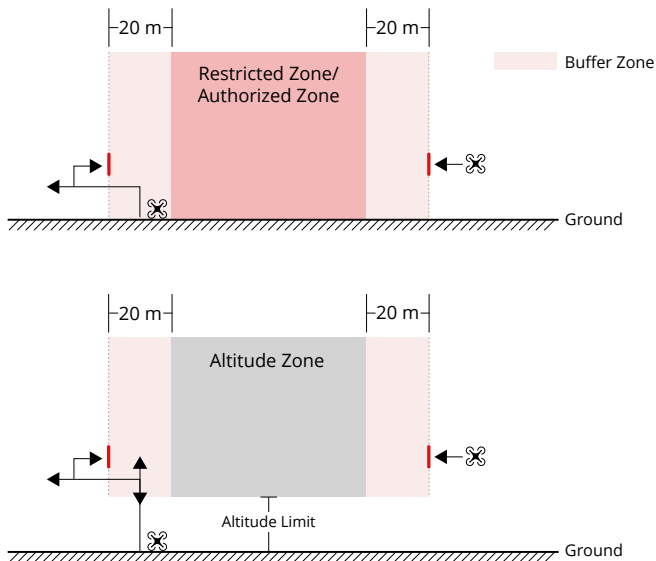

Unlocking GEO Zones

To satisfy the needs of different users, DJI provides two unlocking modes: Self-Unlocking and Custom Unlocking. Users may request either on the DJI Fly Safe website or via a mobile device.

Self-Unlocking is intended for unlocking Authorization Zones. To complete Self-Unlocking, the user must submit an unlocking request via the DJI Fly Safe website at <https://www.dji.com/flysafe>. Once the unlocking request is approved, the user may synchronize the unlocking license through the DJI Pilot 2 app (Live Self-Unlocking). To unlock the zone, alternatively, the user may launch or fly the aircraft directly into the approved Authorization Zone and follow the prompts in DJI Pilot 2 to unlock the zone (Scheduled Self-Unlocking). For Live Self-Unlocking, the user can designate an unlocked period during which multiple flights can be operated. Scheduled Self-Unlocking is only valid for one flight. If the aircraft is restarted, the user will need to unlock the zone again.

Custom Unlocking is tailored for users with special requirements. It designates user-defined custom flight areas and provides flight permission documents specific to the needs of different users. This unlocking option is available in all countries and regions and can be requested via the DJI Fly Safe website at <https://www.dji.com/flysafe>.

Unlocking on Mobile Device: run the DJI Pilot 2 app and tap GEO Zone Map on the home screen. View the list of the unlocking licenses and tap ⓘ to view details of the unlocking license. A link to the unlocking license and a QR code will be displayed. Use your mobile device to scan the QR code and apply to unlock directly from the mobile device.

For more information about unlocking, please visit <https://www.dji.com/flysafe> or contact flysafe@dji.com.

Maximum Altitude & Distance Restrictions

Maximum flight altitude restricts the aircraft flight altitude, while maximum flight distance restricts the aircraft flight radius around the Home Point. These limits can be set using the DJI Pilot 2 app for improved flight safety.

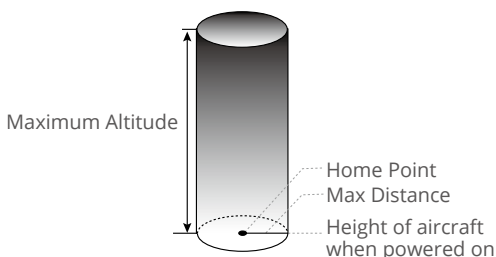

Home Point not manually updated during flight

Strong GNSS Signal		
	Flight Restrictions	Prompt in DJI Pilot 2
Max Altitude	The altitude of the aircraft cannot exceed the value set in DJI Pilot 2.	Aircraft approaching max flight altitude. Fly with caution.
Max Distance	The straight-line distance from the aircraft to the Home Point cannot exceed the max flight distance set in DJI Pilot 2.	Aircraft approaching max flight distance. Fly with caution.

Weak GNSS Signal		
	Flight Restrictions	Prompt in DJI Pilot 2
Max Altitude	When the GNSS signal is weak, namely, when the GNSS icon is yellow or red, and the ambient light is too dark, the max altitude is 3 m (9.84 ft). The max altitude is the relative altitude measured by the infrared sensor. When the GNSS signal is weak, but the ambient light is sufficient, the max altitude is 30 m (98.43 ft).	Aircraft approaching max flight altitude. Fly with caution.
Max Distance	No limit.	N/A



- If there is a strong GNSS signal every time powered on, the altitude limit becomes invalid automatically.
- If an aircraft exceeds a specified limit, the pilot can still control the aircraft but cannot fly any closer to the restricted area.
- For safety reasons, DO NOT fly the aircraft close to airports, highways, railway stations, railway lines, city centers, or other sensitive areas. Only fly the aircraft within a visual line of sight.

DJI AirSense

Airplanes with an ADS-B transceiver will actively broadcast flight information, including locations, flight paths, speeds, and altitudes.

DJI aircraft incorporated with DJI AirSense technology can receive flight information broadcast from ADS-B transceivers that comply with 1090ES or UAT standards within a radius of 10 kilometers. Based on the received flight information, DJI AirSense can analyze and obtain the location, altitude, orientation, and velocity of the surrounding manned airplanes and compare such figures with the DJI aircraft to calculate in real-time the potential risk of collision with the surrounding manned airplanes. DJI AirSense will display a warning message in DJI Pilot 2 according to the risk level.

DJI AirSense only issues warning messages on approaches by specific manned airplanes under special circumstances. Always fly your aircraft within your visual line of sight and be cautious at all times to ensure flight safety. Please be aware that DJI AirSense has the following limitations:

1. DJI AirSense can only receive messages sent by airplanes installed with an ADS-B Out device that is in compliance with 1090ES (RTCA DO-260) or UAT (RTCA Do-282) standards. DJI devices cannot receive broadcast messages from or display warnings on airplanes not equipped with properly functioning ADS-B Out devices.

2. If there is an obstacle between a manned airplane and a DJI aircraft, DJI AirSense will not be able to receive ADS-B messages from the airplane or send warnings to the user. Keenly observe your surroundings and fly with caution.
3. Warning prompts may be delayed if DJI AirSense experiences any interference from the surrounding environment. Keenly observe your surroundings and fly with caution.
4. Warning prompts may not be received if the DJI aircraft is unable to obtain information on its location.
5. DJI AirSense cannot receive ADS-B messages from manned airplanes or send warnings to the user when it is disabled or misconfigured.

When the DJI AirSense system detects a risk, the AR projection display will appear in DJI Pilot 2, intuitively showing the distance between the DJI aircraft and the airplane and issuing a warning alert. Users should follow the instructions in DJI Pilot 2 upon receiving the alert.

1. **Notice:** a blue airplane icon will appear on the map.
2. **Caution:** the app will display the message: "Manned aircraft detected nearby. Fly with caution." A small orange square icon with the distance information will appear on the camera view, and an orange airplane icon will appear on the map view.
3. **Warning:** the app will display the message: "Collision risk. Descend or ascend immediately." If the user is not operating, the app will display: "Collision risk. Fly with caution." A small red square icon with the distance information will appear on the camera view, and a red airplane icon will appear on the map view. The remote controller will vibrate to alert.

Advanced Pilot Assistance Systems (APAS 5.0)

The Advanced Pilot Assistance Systems 5.0 (APAS 5.0) feature is available in Normal mode and Tripod mode. When APAS is enabled, the aircraft will continue to respond to user commands and plan its path according to both control stick inputs and the flight environment. APAS makes it easier to avoid obstacles, obtain smoother footage, and give a better flying experience.

Keep moving the control sticks in any direction. The aircraft will avoid the obstacles by flying above, below, or to the left or right of the obstacle. The aircraft can also respond to the control stick inputs while avoiding obstacles.

When APAS is enabled, the aircraft can be stopped by pressing the flight pause button on the remote controller. The aircraft brakes and hovers for three seconds and awaits further pilot commands.

To enable APAS, enter the camera view in DJI Pilot 2, tap $\dots \rightarrow$ , then Obstacle Avoidance, and enable APAS by selecting Avoid.

Landing Protection

Landing Protection will activate if Obstacle Avoidance is set to Avoid or Brake and the user pulls the throttle stick down to land the aircraft. Landing Protection is enabled once the aircraft begins to land.

1. During Landing Protection, the aircraft will automatically detect and carefully land on suitable ground.
2. If the ground is determined unsuitable for landing, the aircraft will hover when the aircraft descends to 0.8 m above ground. Pull down on the throttle stick for more than five seconds, and the aircraft will land without obstacle avoidance.



- Make sure to use APAS when the Vision Systems are available. Make sure there are no people, animals, objects with small surface areas (e.g., tree branches), or transparent objects (e.g., glass or water) along the desired flight path.
 - Make sure to use APAS when the vision systems are available or the GNSS signal is strong. APAS may not function properly when the aircraft is flying over water or snow-covered areas.
 - Be extra cautious when flying in extremely dark (<300 lux) or bright (>10,000 lux) environments.
 - Pay attention to DJI Pilot 2 and make sure APAS is working normally.
 - APAS may not function properly when the aircraft is flying near flight limits or in a GEO zone.
-

Pre-Flight Checklist

1. Make sure the remote controller and the aircraft batteries are fully charged and the Intelligent Flight Battery is installed firmly.
2. Make sure the propellers are securely mounted and not damaged or deformed, there are no foreign objects in or on the motors or propellers, and the propeller blades and arms are unfolded.
3. Make sure the lenses of the vision systems, cameras, the glass of the infrared sensors, and the auxiliary lights are clean, free of stickers, and not blocked in any way.
4. Make sure to remove the gimbal protector before powering on the aircraft.
5. Make sure the covers of the microSD card slot and the PSDK port have been closed properly.
6. Make sure the remote controller antennas are adjusted to the proper position.
7. Make sure DJI Pilot 2 and the aircraft firmware have been updated to the latest version.
8. Power on the aircraft and the remote controller. Make sure the status LED on the remote controller and the battery level indicators on the aircraft are solid green. This indicates that the aircraft and the remote controller are linked, and the remote controller is in control of the aircraft.
9. Make sure your flight area is outside any GEO zones, and flight conditions are suitable for flying the aircraft. Place the aircraft on open and flat ground. Make sure there are no

obstacles, buildings, or trees nearby and that the aircraft is 5 m away from the pilot. The pilot should be facing the rear of the aircraft.

- 10. To ensure flight safety, enter the camera view of DJI Pilot 2 and check the parameters on the pre-flight checklist, such as the failsafe settings, control stick mode, RTH height, and obstacle distance. It is recommended to set the out-of-control action to RTH.
- 11. Make sure DJI Pilot 2 is properly opened to assist your operation of the aircraft. WITHOUT THE FLIGHT DATA RECORDED BY THE DJI PILOT 2 APP, IN CERTAIN SITUATIONS (INCLUDING THE LOSS OF YOUR AIRCRAFT), DJI MAY NOT BE ABLE TO PROVIDE AFTERSALES SUPPORT TO YOU OR ASSUME LIABILITY.
- 12. Divide the airspace for flight when multiple aircraft are operating simultaneously in order to avoid collision mid-air.

Starting/Stopping the Motors

Starting the Motors

A Combination Stick Command (CSC) is used to start the motors. Push both sticks to the inner or outer bottom corners to start the motors. Once the motors start spinning, release both sticks simultaneously.

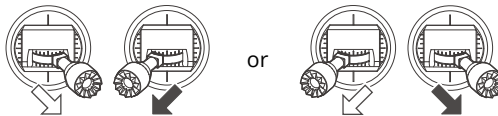

Stopping the Motors

The motors can be stopped in two ways:

Method 1: when the aircraft has landed, push the throttle stick down and hold. The motors will stop after three seconds.

Method 2: when the aircraft has landed, push the throttle stick down, and perform the same CSC used to start the motors. Release both sticks once the motors have stopped.

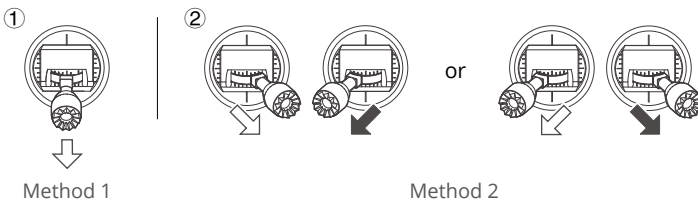

Stopping the Motors Mid-Flight

Stopping motors mid-flight will cause the aircraft to crash. The motors should only be stopped mid-flight in an emergency situation, such as if the aircraft is involved in a collision, a motor has stalled, the aircraft is rolling in the air, or the aircraft is out of control and is ascending or descending very quickly. To stop the motors mid-flight, perform the same CSC that was used to start the motors. The default setting can be changed in DJI Pilot 2.

Flight Test

1. Place the aircraft in an open, flat area with the aircraft rear facing towards you.
2. Power on the remote controller and the aircraft.
3. Launch DJI Pilot 2 and enter the camera view.
4. Wait for the aircraft self-diagnostics to complete. If DJI Pilot 2 does not show any irregular warning, you can start the motors.
5. Push the throttle stick up slowly to take off.
6. To land, hover over a level surface and gently push the throttle stick down to descend.
7. After landing, push the throttle down and hold. The motors will stop after three seconds.
8. Power off the Intelligent Flight Battery before the remote controller.



Make sure to place the aircraft on a flat and steady surface before takeoff. DO NOT launch the aircraft from your palm or while holding it with your hand.

Aircraft

DJI Mavic 3E/3T contains a flight controller, video downlink system, vision systems, infrared sensing system, propulsion system, and an Intelligent Flight Battery.

Flight Modes

DJI Mavic 3E/3T supports the following flight modes:

Normal Mode:

The aircraft utilizes GNSS, the Horizontal Omnidirectional, Upward, and Downward Vision Systems, and the Infrared Sensing System to locate itself and stabilize. When the GNSS signal is strong, the aircraft uses GNSS to locate itself and stabilize. When the GNSS is weak, but the lighting and other environmental conditions are sufficient, it uses the vision systems. When the vision systems are enabled, and lighting and other environmental conditions are sufficient, the maximum tilt angle is 30° and the maximum flight speed is 15 m/s.

Sport Mode:

In Sport mode, the aircraft uses GNSS for positioning and the aircraft responses are optimized for agility and speed, making it more responsive to control stick movements. Note: obstacle sensing is disabled and the maximum flight speed is 21 m/s (19 m/s when flying in the EU).

Function Mode:

Function mode can be set to T-mode (Tripod mode) or A-mode (Attitude mode) in DJI Pilot 2. T-mode is based on Normal mode. The flight speed is limited to allow easier control of the aircraft. Attitude mode must be used with caution.

The aircraft automatically changes to A-mode when the vision systems are unavailable or disabled and when the GNSS signal is weak or the compass experiences interference. In A-mode, the aircraft may be more easily affected by its surroundings. Environmental factors such as wind can result in horizontal shifting, which may present hazards, especially when flying in confined spaces.



DO NOT switch from Normal mode to other modes unless you are sufficiently familiar with the aircraft behavior under each flight mode. You must turn on Multiple Flight Modes in DJI Pilot 2 before switching from Normal mode to other modes.



- The vision systems are disabled in Sport mode, which means the aircraft cannot sense obstacles on its route automatically. The user must stay alert to the surrounding environment and control the aircraft to avoid obstacles.
- The maximum speed and braking distance of the aircraft significantly increase in Sport mode. A minimum braking distance of 30 m is required in windless conditions.
- A minimum braking distance of 10 m is required in windless conditions while the aircraft is ascending and descending in Sport mode or Normal mode.
- The responsiveness of the aircraft significantly increases in Sport mode, which means a small control stick movement on the remote controller translates into the aircraft moving a large distance. Make sure to maintain adequate maneuvering space during flight.
- When switching the GNSS to the BeiDou satellite positioning system in DJI Pilot 2, the aircraft only uses a single positioning system and the satellite search capability becomes poor. Fly with caution.

Aircraft Status Indicator

DJI Mavic 3E/3T has front LEDs and aircraft status indicators.

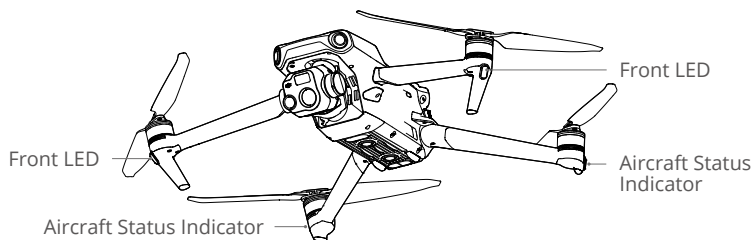

When the aircraft is powered on, but the motors are not running, the front LEDs glow solid red to display the orientation of the aircraft.

When the aircraft is powered on, but the motors are not running, the aircraft status indicators will display the current status of the flight control system. Refer to the table below for more information about the aircraft status indicators.

Aircraft Status Indicators Descriptions

Normal States		
	Blinks red, yellow, and green alternately	Powering on and performing self-diagnostic tests
	Blinks yellow four times	Warming up
	Blinks green slowly	GNSS enabled
	Blinks green twice repeatedly	Vision systems enabled
	Blinks yellow slowly	GNSS and vision systems disabled (ATTI mode enabled)
Warning States		
	Blinks yellow quickly	Remote controller signal lost
	Blinks red slowly	Takeoff is disabled, e.g. low battery*
	Blinks red quickly	Critically low battery
	Solid Red	Critical error
	Blinks red and yellow alternately	Compass calibration required

* If the aircraft cannot takeoff while the status indicators are blinking red slowly, connect to the remote controller, run DJI Pilot 2, and view the details.

After the motor starts, the front LEDs blink red and green alternately, and the aircraft status indicators blink green.

- ⚠ To obtain better footage, the front LEDs turn off automatically when shooting if the front LEDs are set to auto in DJI Pilot 2. Lighting requirements vary depending on the region. Observe local laws and regulations.
-

Beacon and Auxiliary Light

Beacon

The beacon on the top of the aircraft enables you to find the aircraft when flying at night. The beacon can be manually turned on or off in DJI Pilot 2.

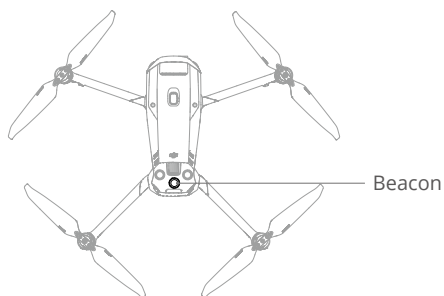

- ⚠ DO NOT look directly at the beacon when it is in use to avoid damaging your eyes.
-

Auxiliary Light

The auxiliary light located at the bottom of the aircraft will automatically turn on in poor light conditions to assist the downward vision system. The light can also be manually turned on or off in DJI Pilot 2.

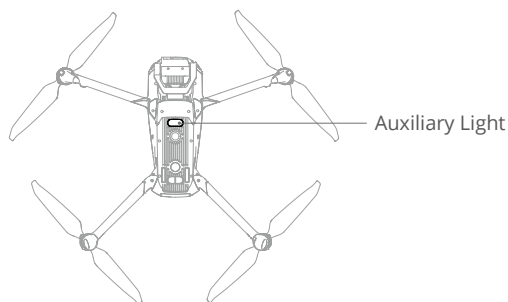

- ⚠ The auxiliary light will automatically turn on in low-light environments when the flight altitude is under 5 m. Note that the positioning performance of the vision systems may be affected. Fly with caution if the GNSS signal is weak.
-

Flight Recorder

Flight data, including flight telemetry, aircraft status information, and other parameters, are automatically saved to the internal data recorder of the aircraft. The data can be accessed using DJI Assistant 2 (Enterprise Series).

Propellers

There are two types of DJI Mavic 3E/3T Quick-Release Propellers designed to spin in different directions. Marks are used to indicate which propellers should be attached to which motors. Make sure to match the propeller and motor following the instructions.

Attaching the Propellers

Attach the propellers with marks to the motors with marks and the unmarked propellers to the motors without marks. Hold the motor, press the propeller down, and rotate in the direction marked on the propeller until it pops up and locks in place.

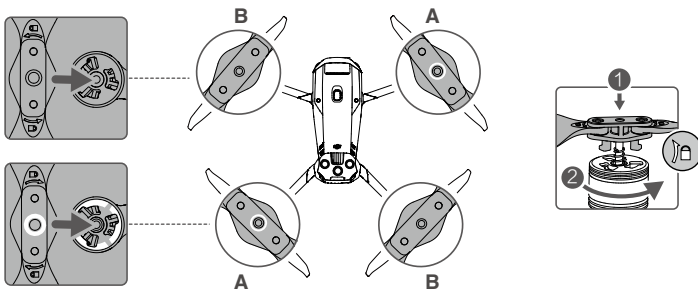

Detaching the Propellers

Hold the motor, press the propeller down, and rotate in the opposite direction to the one marked on the propeller until it pops out.



- The propeller blades are sharp. Handle with care.
- Only use official DJI propellers. DO NOT mix propeller types.
- Propellers are consumable components. Purchase additional propellers if necessary.
- Make sure that the propellers and motors are installed securely before each flight.
- Make sure that all propellers are in good condition before each flight. DO NOT use aged, chipped, or broken propellers.
- To avoid injury, stay away from rotating propellers or motors.
- To avoid damaging the propellers, place the aircraft in the direction shown in the carrying case during transportation or storage. DO NOT squeeze or bend the propellers. If propellers are damaged, the flight performance is affected.
- Make sure the motors are mounted securely and rotating smoothly. Land the aircraft immediately if a motor is stuck and unable to rotate freely.

- ⚠ • DO NOT attempt to modify the structure of the motors.
 - DO NOT touch or let hands or body parts come in contact with the motors after flight as they may be hot.
 - DO NOT block any of the ventilation holes on the motors or the body of the aircraft.
 - Make sure the ESCs sound normal when powered on.
-

Intelligent Flight Battery

The Mavic 3 Intelligent Flight Battery is a 15.4V, 5000mAh battery with smart charging and discharging functionality.

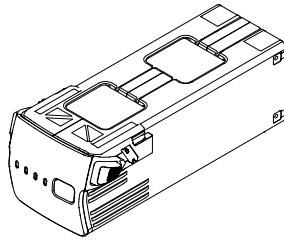

Battery Features

1. **Battery Level Display:** the battery level LEDs display the current battery level.
2. **Auto-Discharging:** to prevent swelling, the battery automatically discharges to 96% battery level when idle for three days and automatically discharges to 60% battery level when idle for nine days (the default is nine days, but it can be set to 4-9 days in the app). It is normal to feel moderate heat being emitted from the battery during the discharging process.
3. **Balanced Charging:** during charging, the voltages of the battery cells are automatically balanced.
4. **Overcharge Protection:** the battery stops charging automatically once fully charged.
5. **Temperature Detection:** to prevent damage, the battery only charges when the temperature is between 5° and 40° C (41° and 104° F).
6. **Overcurrent Protection:** the battery stops charging if an excess current is detected.
7. **Over-Discharge Protection:** discharging stops automatically to prevent excess discharge when the battery is not in use. Over-discharge protection is not enabled when the battery is in use.
8. **Short Circuit Protection:** the power supply is automatically cut if a short circuit is detected.

9. Battery Cell Damage Protection: the app will display a warning prompt when a damaged battery cell is detected.
10. Hibernation Mode: the battery switches off after 20 minutes of inactivity to save power. If the battery level is less than 5%, the battery enters Hibernation mode to prevent over-discharge after being idle for six hours. In Hibernation mode, the battery level indicators do not illuminate. Charge the battery to wake it from hibernation.
11. Communication: information about the voltage, capacity, and current of the battery is transmitted to the aircraft.

 Refer to the Safety Guidelines and the stickers on the battery before use. Users shall take full responsibility for all operations and usage.

Using the Battery



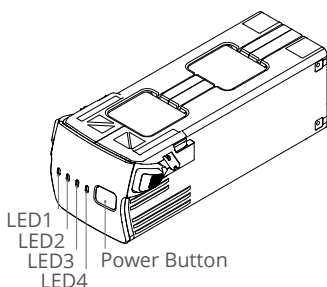

Checking the Battery Level

Press the power button once to check the battery level.



 The battery level LEDs display the power level of the battery during charging and discharging. The statuses of the LEDs are defined below:

LED is on.  LED is blinking. LED is off.

LED1	LED2	LED3	LED4	Battery Level
<input type="radio"/>	<input type="radio"/>	<input type="radio"/>	<input type="radio"/>	89%-100%
<input type="radio"/>	<input type="radio"/>	<input type="radio"/>		76%-88%
<input type="radio"/>	<input type="radio"/>	<input type="radio"/>	<input type="radio"/>	64%-75%
<input type="radio"/>	<input type="radio"/>		<input type="radio"/>	51%-63%
<input type="radio"/>	<input type="radio"/>	<input type="radio"/>	<input type="radio"/>	39%-50%
<input type="radio"/>		<input type="radio"/>	<input type="radio"/>	26%-38%
<input type="radio"/>	<input type="radio"/>	<input type="radio"/>	<input type="radio"/>	14%-25%
	<input type="radio"/>	<input type="radio"/>	<input type="radio"/>	1%-13%

Powering On/Off

Press the power button once, then press again, and hold for two seconds to power the battery on or off. The battery level LEDs display the battery level when the aircraft is powered on.

Low-Temperature Notice

1. Battery capacity is significantly reduced when flying at low temperatures from -10° to 5° C (14° to 41° F). It is recommended to hover the aircraft in place for a while to heat the battery. Make sure to charge the battery fully before takeoff.
2. Batteries cannot be used in extremely low-temperature environments of lower than -10° C (14° F).
3. When in low-temperature environments, end the flight as soon as DJI Pilot 2 displays the low battery level warning.
4. To ensure optimal performance, keep the battery temperature above 20° C (68° F).
5. The reduced battery capacity in low-temperature environments reduces the wind speed resistance performance of the aircraft. Fly with caution.
6. Fly with extra caution at high altitudes.

Charging the Battery

Fully charge the battery before each use. Only use a DJI-approved charging device to charge the Intelligent Flight Battery.

Using the Charging Hub

DJI Mavic 3 Battery Charging Hub (100W) is designed for use with Mavic 3 Intelligent Flight Batteries. When used with the DJI USB-C Power Adapter (100W), it can charge up to three Intelligent Flight Batteries in sequence from high to low power levels. The charging time for one battery is approximately 1 hour and 10 minutes.

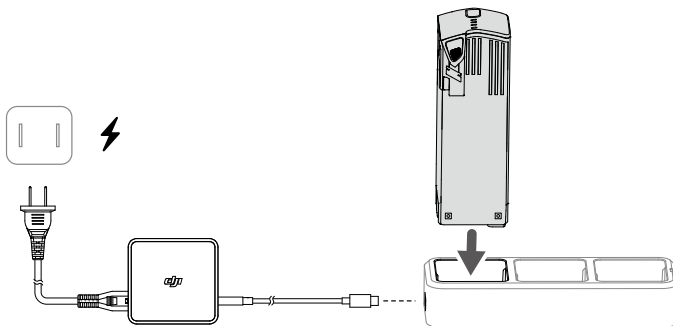

How to Charge

1. Insert the Intelligent Flight Battery into the battery port. Connect the charging hub to a power outlet (100-240 V, 50-60 Hz) using the DJI USB-C Power Adapter (100W).
2. The Intelligent Flight Battery with the highest power level will be charged first, and then the rest will be charged in sequence according to their power levels. Refer to the Status LED Indicator Descriptions for more information about the blinking patterns of the status LED indicator.
3. The Intelligent Flight Battery can be disconnected from the charging hub when charging is complete.

Status LED Indicator Descriptions

Blinking Pattern	Description
Solid yellow	No battery is inserted
Pulses green	Charging
Solid green	All batteries fully charged
Blinks yellow	Temperature of batteries too low or too high (no further operation needed)
Solid red	Power supply or battery error (remove and reinsert the batteries or unplug and plug in the charger)



- It is recommended to use a DJI USB-C Power Adapter (100W) when using the Mavic 3 Battery Charging Hub to charge Mavic 3 Intelligent Flight Batteries.
- The charging hub is only compatible with BWX260-5000-15.4 Intelligent Flight Batteries. DO NOT attempt to use the charging hub with other battery models.
- Place the charging hub on a flat and stable surface when in use. Make sure the device is properly insulated to prevent fire hazards.
- DO NOT attempt to touch the metal terminals on the battery case.
- Clean the metal terminals with a clean, dry cloth if there is any noticeable buildup.

Using DJI USB-C Power Adapter (100W)

1. Connect the charger to an AC power supply (100-240V, 50/60 Hz; use a power adapter if necessary).
2. Connect the aircraft to the charger with the battery powered off.
3. The battery level LEDs display the current battery level during charging.
4. The Intelligent Flight Battery is fully charged when all the battery level LEDs are off. Detach the charger when the battery is fully charged.

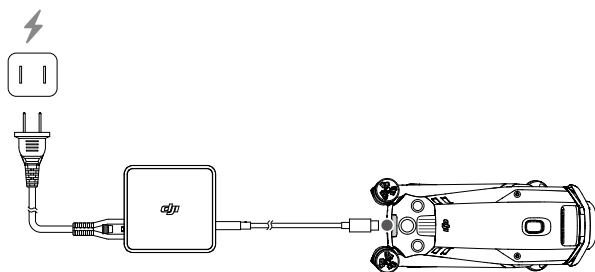

- ⚠ • DO NOT charge an Intelligent Flight Battery immediately after flight as it may be too hot. Wait for the battery to cool down to the operating temperature before charging again.
- The charger stops charging the battery if the battery cell temperature is not within the operating range of 5° to 40° C (41° to 104° F). The ideal charging temperature is from 22° to 28° C (71.6° to 82.4° F).
- Fully charge the battery at least once every three months to maintain battery health.
- DJI does not take any responsibility for damage caused by third-party chargers.

☀ For safety purposes, keep the batteries at a low power level in transit. This can be done by flying the aircraft outdoors until there is less than 30% charge left.

The table below shows the battery level during charging.

LED1	LED2	LED3	LED4	Battery Level
☀	☀	○	○	1%-50%
☀	☀	☀	○	51%-75%
☀	☀	☀	☀	76%-99%
○	○	○	○	100%

Battery Protection Mechanisms

The battery level LEDs can display battery protection notifications triggered by abnormal charging conditions.

Battery Protection Mechanisms					
LED1	LED2	LED3	LED4	Blinking Pattern	Status
○	☀	○	○	LED2 blinks twice per second	Overcurrent detected
○	☀	○	○	LED2 blinks three times per second	Short circuit detected
○	○	☀	○	LED3 blinks twice per second	Overcharge detected
○	○	☀	○	LED3 blinks three times per second	Over-voltage charger detected
○	○	○	☀	LED4 blinks twice per second	Charging temperature is too low
○	○	○	☀	LED4 blinks three times per second	Charging temperature is too high

If any of the battery protection mechanisms are activated, unplug the charger, and plug it in again to resume charging. If the charging temperature is abnormal, wait for it to return to normal. The battery will automatically resume charging without the need to unplug and plug the charger again.

Inserting the Intelligent Flight Battery

Insert the Intelligent Flight Battery into the battery compartment of the aircraft. Make sure it is mounted securely and that the battery buckles are clicked into place.

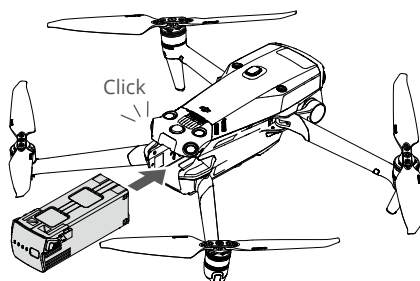

Removing the Intelligent Flight Battery

Press the textured part of the battery buckles on the sides of the battery to remove it from the compartment.

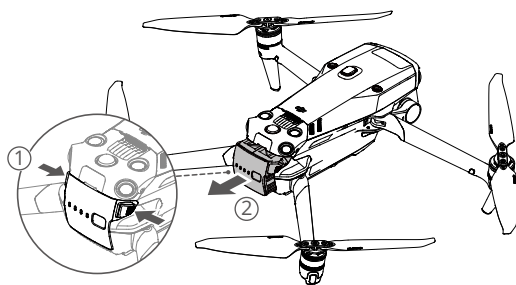

- DO NOT insert or remove the battery while the aircraft is powered on.
 - Make sure the battery is mounted securely.
-

Gimbal

Gimbal Profile

The DJI Mavic 3E/3T 3-axis gimbal stabilizes the camera, allowing you to capture clear and steady images and videos at high flight speed. The control tilt range is -90° to $+35^{\circ}$.

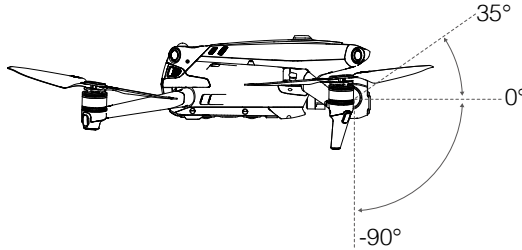

Use the gimbal dial on the remote controller to control the tilt of the camera. Alternatively, enter the camera view in DJI Pilot 2. Press the screen until a circle appears and drag the circle up and down to control the tilt of the camera.

Gimbal Mode

The gimbal operates in Follow mode: the tilt angle of the gimbal remains stable relative to the horizontal plane, which is suitable for shooting stable images. Users can adjust the gimbal tilt.



- DO NOT tap or knock the gimbal after the aircraft is powered on. Launch the aircraft from open and flat ground to protect the gimbal during takeoff.
- Precision elements in the gimbal may be damaged by a collision or impact, which may cause the gimbal to function abnormally.
- Avoid getting dust or sand on the gimbal, especially in the gimbal motors.
- A gimbal motor may enter protection mode in the following situations: a. The aircraft is on uneven ground, and the gimbal is obstructed. b. The gimbal experiences an excessive external force, such as during a collision.
- DO NOT apply external force to the gimbal after the gimbal is powered on. DO NOT add any extra payload to the gimbal, as this may cause the gimbal to function abnormally or even lead to permanent motor damage.
- Make sure to remove the gimbal protector before powering on the aircraft. Also, make sure to mount the gimbal protector when the aircraft is not in use.
- Flying in heavy fog or clouds may make the gimbal wet, leading to temporary failure. The gimbal will recover full functionality once it is dry.

Camera

Camera Profile

Both DJI Mavic 3E and DJI Mavic 3T integrate a tele camera and a wide camera, which enable users to quickly switch to a highly magnified zoom view for detailed observation after recognizing a target in the wide-angle camera view. Mavic 3T is also equipped with a long-wave infrared thermal imaging camera, which can shoot thermal images.

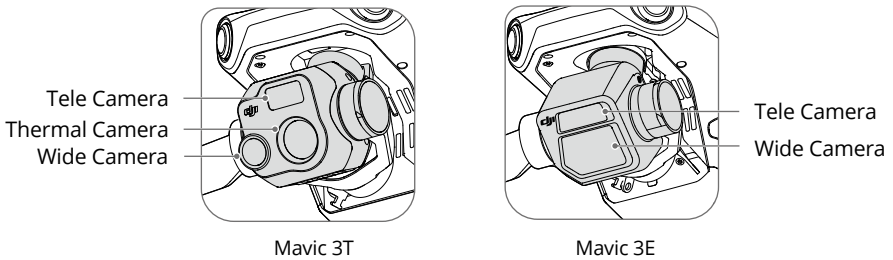

Mavic 3E

Mavic 3E's wide-angle 4/3 CMOS, 20MP sensor has a mechanical shutter to prevent motion blur and supports rapid 0.7-second interval shooting. Large 3.3 μm pixels that, together with Smart Low-Light Photo, offer significantly improved performance in dim conditions. The tele camera boasts a 1/2-in CMOS sensor, capable of shooting 12MP photos with an aperture of $f/4.4$ and shooting at 3 m to infinity, supporting up to 56 \times Max Hybrid Zoom.

Mavic 3T

Mavic 3T's wide camera boasts a 1/2-in CMOS sensor, capable of shooting 48MP photos with an aperture of $f/2.8$ and shooting at 1 m to infinity.

The tele camera boasts a 1/2-in CMOS sensor, capable of shooting 12MP photos with an aperture of $f/4.4$ and shooting at 3 m to infinity, supporting up to 56 \times Max Hybrid Zoom.

The thermal camera has 640 \times 512 resolution and, together with the tele camera, supports 28 \times continuous side-by-side zoom for easy comparisons.



- DO NOT expose the thermal camera lenses to strong sources of energy such as the sun, lava, or a laser beam. Otherwise, the camera sensor may be burned, leading to permanent damage.
- Make sure the temperature and humidity are suitable for the camera during use and storage.
- Use a lens cleanser to clean the lens to avoid damage or poor image quality.
- DO NOT block any ventilation holes on the camera as the heat generated may damage the device and injure the user.

Storing Photos and Videos

A microSD card is in the microSD card slot when shipped. The aircraft supports microSD cards with a maximum capacity of up to 512 GB. To ensure that the camera can quickly read and write data for HD video recording, use a microSD card with UHS Speed Class 3 or above and a write speed greater than 30 MB/s. Refer to the Recommended microSD Cards in specifications.

- ⚠ DO NOT remove the microSD card from the aircraft when recording. Otherwise, the microSD card may be damaged.
- To ensure the stability of the camera system, single video recordings are limited to 30 minutes.
- Check camera settings before use to ensure they are configured correctly.
- Before shooting important photos or videos, shoot a few images to test whether the camera is operating correctly.
- Photos and videos cannot be transmitted or copied from the camera if the aircraft is powered off.
- Make sure to power off the aircraft correctly. Otherwise, the camera parameters will not be saved, and any recorded videos may be affected. DJI is not responsible for any loss caused by an image or video recorded in a way that is not machine-readable.

PSDK Port

DJI Mavic 3E/3T features a PSDK port for mounting additional compatible DJI modular accessories that are listed below:

Speaker: used for long-range, real-time broadcasting or audio playback.

RTK module: tracks the dual-frequency multi-mode signals of visible satellites in complex environments, provides higher accuracy and more reliable data for positioning, and improves the anti-interference ability in strong magnetic environments, which ensures reliable operation and flight. When used with a D-RTK 2 High Precision GNSS Mobile Station or a custom Network RTK, more accurate positioning data can be obtained.

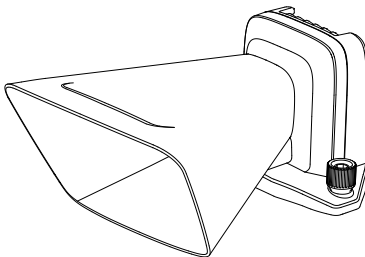

Speaker

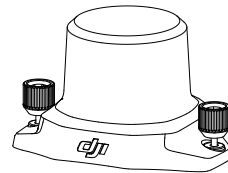

RTK Module

Usage

The following example illustrates how to install and use modular accessories. The RTK module is used as an example.

1. Remove the PSDK port cover on the top of the aircraft when the aircraft is powered off.
2. Mount the RTK module onto the PSDK port of the aircraft.
3. Tighten the knobs on both sides to ensure that the RTK module is firmly mounted onto the aircraft.

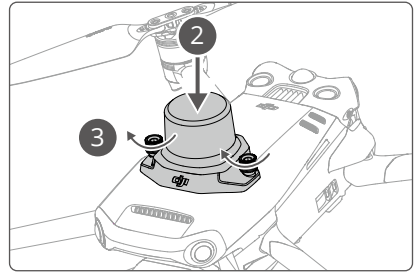
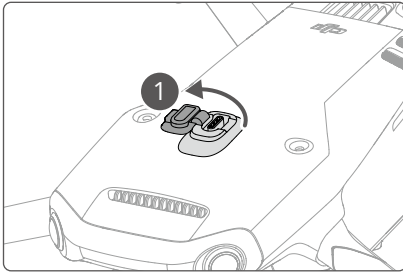

4. Power on the aircraft and launch DJI Pilot 2 to use the accessory.

-
- ⚠**
- Make sure that the accessories are correctly and securely mounted on the aircraft before use. Otherwise, they may fall from the aircraft during flight.
 - DO NOT use the speaker near people or in an urban area where noise-sensitive structures are concentrated, as the loudness could lead to accidents or injuries.
 - It is recommended to use the DJI RC Pro Enterprise remote controller to play vocals or import a vocal source for the best playback effect. It is not recommended to play single-frequency sounds such as an alarm to avoid irreversible damage to the speaker.
 - The RTK module does not support hot swapping. Please avoid blocking the RTK module to ensure positioning accuracy.
-

Using the RTK Module

Enabling/Disabling RTK

Ensure that the RTK function is enabled and the RTK service type is correctly set (D-RTK 2 Mobile Station or Network RTK) before each use. Otherwise, RTK cannot be used for positioning. Go to the camera view in the DJI Pilot 2 app, tap **...** -> **RTK**, to check the settings. Make sure to disable the RTK function if not in use. Otherwise, the aircraft will not be able to take off when there is no differential data.

-
- ☀**
- RTK positioning can be enabled and disabled during flight. Remember to select an RTK service type first.
 - After RTK is enabled, Maintain Positioning Accuracy mode can be used.
-

DJI D-RTK 2 Mobile Station

1. Refer to the D-RTK 2 High Precision GNSS Mobile Station User Guide (available from <https://www.dji.com/mavic-3-enterprise/downloads>) to set up the D-RTK 2 Mobile Station and link the aircraft and the station. Power on the D-RTK 2 Mobile Station and switch to the Broadcast mode for the Mavic 3 Enterprise Series.
2. In the RTK settings in the app, select D-RTK 2 Mobile Station as the RTK service type, connect to the mobile station by following the on-screen instructions, and wait for the system to search for a satellite. When the status of the aircraft's positioning in the status table shows FIX, it indicates that the aircraft has obtained and used differential data from the mobile station.
3. D-RTK 2 Mobile Station communication distance: 12 km (NCC/FCC), 6 km (SRRC/CE/MIC).

Custom Network RTK

To use Custom Network RTK, make sure that the remote controller has a Wi-Fi connection. Custom Network RTK can be used to replace the D-RTK 2 Mobile Station. Connect the Custom Network RTK account to the designated NTRIP server to send and receive differential data. Keep the remote controller turned on and connected to the internet when using this function.

1. Make sure that the remote controller is connected to the aircraft and the internet.
2. Go to the camera view in the DJI Pilot 2 app, tap **...** -> **RTK**, select Custom Network RTK as the RTK service type and fill in the required information. Then tap Save.
3. Wait to connect to the NTRIP server. In the RTK settings, when the status of the aircraft's positioning in the status table shows FIX, it indicates that the aircraft has obtained and used differential data from Custom Network RTK.

Remote Controller

The DJI RC Pro Enterprise remote controller features O3 Enterprise. The latest version of DJI's signature OcuSync image transmission technology works at both 2.4 and 5.8 GHz, is capable of selecting the best transmission channel automatically, and can transmit a live HD view from the camera of the aircraft at a distance of up to 15 km. The built-in 5.5-in high-brightness 1000 cd/m² screen boasts a resolution of 1920×1080 pixels, while the remote controller comes with a wide range of aircraft and gimbal controls and customizable buttons. Users can connect to the internet via Wi-Fi, and the Android 10 operating system comes with a variety of functions such as Bluetooth and GNSS (GPS+GLONASS+Galileo).

With the built-in microphone and speaker, the remote controller supports H.264 4K/120fps and H.265 4K/120fps video (the actual display effect depends on the resolution and frame rate of the screen), which also supports video output via the Mini HDMI port. The internal storage of the remote controller is 64 GB and supports the use of microSD cards to store photos and videos.

The 5000mAh 36Wh battery provides the remote controller a maximum operating time of 3 hours.

Remote Controller System Interface

Homepage

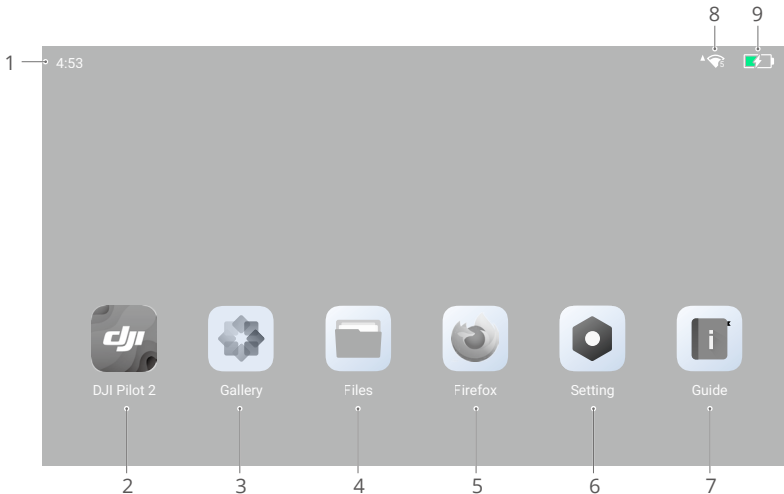

1. **Time**

Displays current time.

2. **DJI Pilot 2 App**

Tap to enter DJI Pilot 2.

3. **Gallery**

Tap to view stored images and videos.

4. **Files**

Tap to view stored files.

5. **Browser**

Tap to open the browser.

6. **Settings**

Tap to enter system settings.

7. **Guide**

Tap to read the guide with detailed information on the remote controller buttons and LEDs.

8. **Wi-Fi Signal**

Displays Wi-Fi signal strength when connected to a Wi-Fi network. Wi-Fi can be enabled or disabled in the shortcut or system settings.

9. **Battery Level**

Displays the battery level of the internal battery of the remote controller. The icon  indicates that the battery is charging.

Screen Gestures

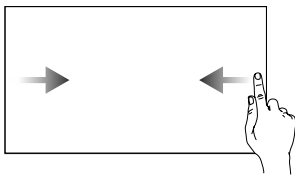

Slide from the left or right to the center of the screen to return to the previous screen.

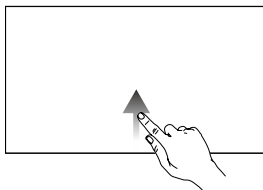

Slide up from the bottom of the screen to return to the homepage.

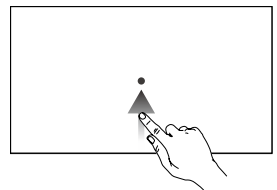

Slide up from the bottom of the screen and hold to access recently opened apps.

Shortcut Settings

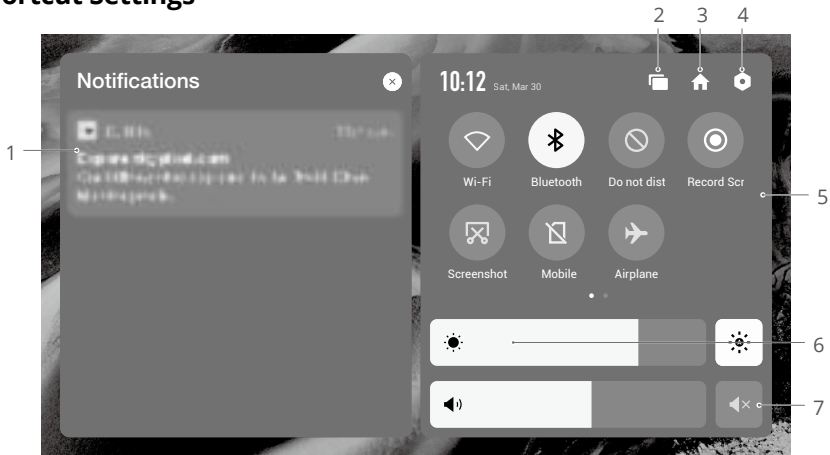

1. Notifications

Tap to view system or app notifications.

2. Recent

Tap  to view and switch to recently opened apps.

3. Home

Tap  to return to the homepage.

4. System Settings

Tap  to access system settings.

5. Shortcuts

 : tap to enable or disable Wi-Fi. Hold to enter settings and connect to or add a Wi-Fi network.

 : tap to enable or disable Bluetooth. Tap and hold to open settings and connect with nearby Bluetooth devices.

 : tap to enable DO NOT Disturb mode. In this mode, system prompts will be disabled.

 : tap to start screen recording.

 : tap to screenshot the screen.

 : mobile data.

 : tap to enable Airplane mode. Wi-Fi, Bluetooth, and mobile data will be disabled.

6. Adjust Brightness

Slide the bar to adjust the brightness. Tap the icon  to auto-brightness mode. Tap or slide the bar to switch to manual brightness mode.

7. Adjust Volume

Slide the bar to adjust the volume and tap  to mute. Note that after muting, all sounds of the remote controller will be completely disabled, including related alarm sounds. Please turn on the mute with caution.

Remote Controller LEDs and Alerts

Remote Controller LEDs

Status LED

Blinking Pattern	Descriptions
Solid red	Disconnected from the aircraft
Blinks red	The temperature of the remote controller is too high, or the battery level of the aircraft is low
Solid green	Connected with the aircraft
Blinks blue	The remote controller is linking to an aircraft
Solid yellow	Firmware update failed
Blinks yellow	The battery level of the remote controller is low
Blinks cyan	Control sticks not centered

Battery Level LEDs

Blinking Pattern				Battery Level
●	●	●	●	76%-100%
●	●	●	○	51%-75%
●	●	○	○	26%-50%
●	○	○	○	1%-25%

Remote Controller Alert

The remote controller vibrates or beeps twice to indicate an error or warning. Pay attention to the prompts that appear on the touchscreen or in DJI Pilot 2. Slide down from the top and select Mute to disable alerts.

Operation

Powering On/Off

Press the power button once to check the current battery level.

Press once, then press again and hold for two seconds to power the remote controller on or off.

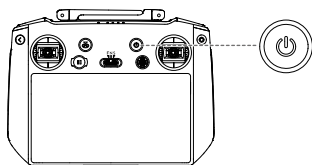

Charging the Battery

Use a USB-C cable to connect the charger to the USB-C port of the remote controller.

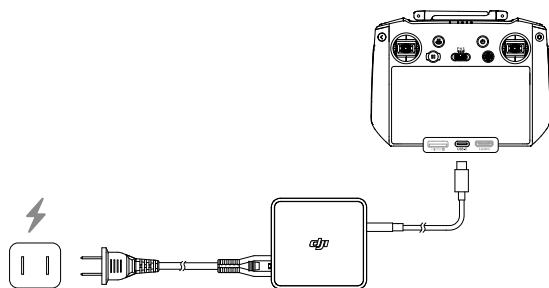

 Fully discharge and charge the remote controller every three months. The battery depletes when stored for an extended period.

-  • The remote controller cannot be powered on before activating the internal battery.
- It is recommended to use the included USB-C to USB-C cable for optimal charging.

Controlling the Gimbal and Camera

Focus/Shutter Button: press halfway down to auto-focus and press all the way down to take a photo.

Record Button: press once to start or stop recording.

Camera Control Dial: adjust the zoom.

Gimbal Dial: control the tilt of the gimbal.

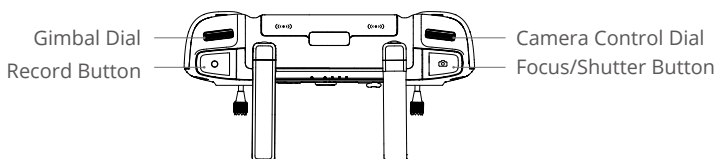

Controlling the Aircraft

The control sticks can be operated in Mode 1, Mode 2, or Mode 3, as shown below.

Mode 1

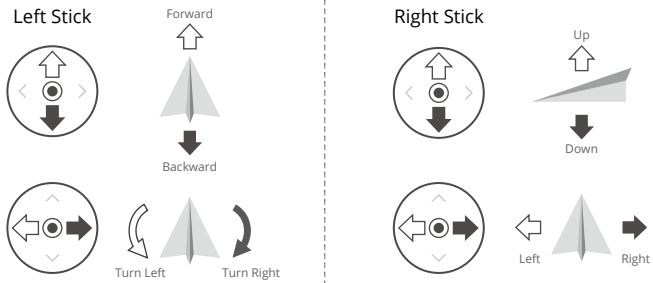

Mode 2

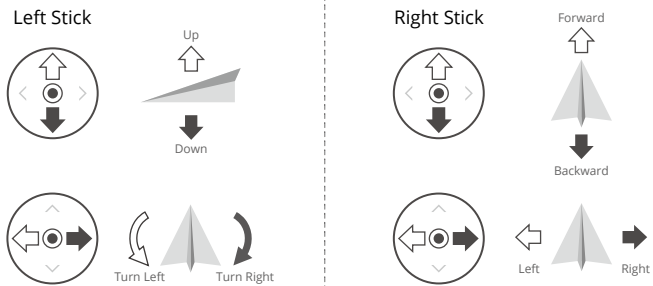

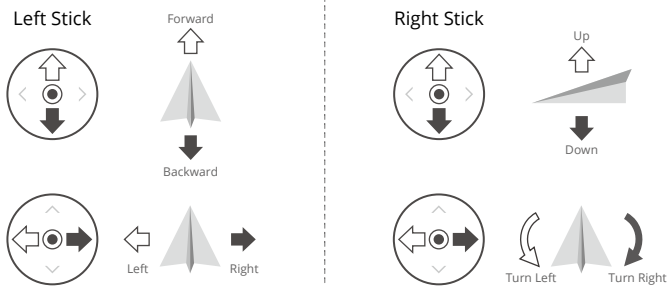

Mode 3



The default control mode of the remote controller is Mode 2. In this manual, Mode 2 is used as an example to illustrate how to use the control sticks.

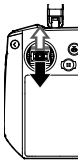
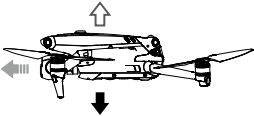
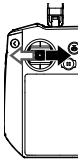
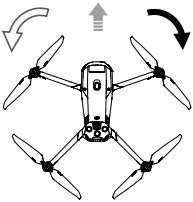
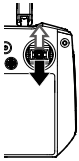
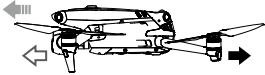
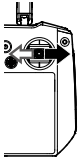

- Stick Neutral/Center Point: control sticks are in the center.
- Moving the control stick: the control stick is pushed away from the center position.

Remote Controller (Mode 2)	Aircraft (◀ Indicates nose direction)	Remarks
		<p>Throttle Stick: moving the left stick up or down changes the altitude of the aircraft.</p> <p>Push the stick up to ascend and push down to descend. The aircraft hovers in place if the stick is in the center. Use the left stick to take off when the motors are spinning at an idle speed.</p> <p>The more the stick is pushed away from the center, the faster the aircraft changes elevation. Push the stick gently to prevent sudden and unexpected changes in altitude.</p>
		<p>Yaw Stick: moving the left stick to the left or right controls the orientation of the aircraft.</p> <p>Push the stick left to rotate the aircraft counterclockwise and right to rotate the aircraft clockwise. The aircraft hovers in place if the stick is in the center.</p> <p>The more the stick is pushed away from the center, the faster the aircraft rotates.</p>
		<p>Pitch Stick: moving the right stick up and down to change the pitch of the aircraft.</p> <p>Push the stick up to fly forward and down to fly backward. The aircraft hovers in place if the stick is in the center.</p> <p>The more the stick is pushed away from the center, the faster the aircraft moves.</p>
		<p>Roll Stick: moving the right stick to the left or right changes the roll of the aircraft.</p> <p>Push the stick left to fly left and right to fly right. The aircraft hovers in place if the stick is in the center.</p> <p>The more the stick is pushed away from the center, the faster the aircraft moves.</p>



- Keep the remote controller away from magnetic materials such as magnets and loudspeaker boxes to avoid magnetic interference.
- To avoid damage to the control sticks, it is recommended that the remote controller be stored in the carrying case when being carried or transported.

Flight Mode Switch

Toggle the switch to select the desired flight mode.

Position	Flight Mode
F	Function mode
N	Normal mode
S	Sport mode

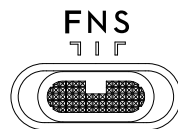

Function mode can be set to T-mode (Tripod mode) or A-mode (Attitude mode) in DJI Pilot 2.

RTH Button

Press and hold the RTH button until the remote controller beeps to start RTH. The aircraft will fly to the last updated Home Point. Press the button again to cancel RTH and regain control of the aircraft. Refer to the Return to Home section for more information about RTH.

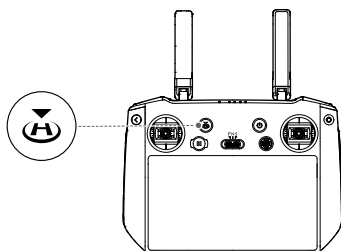

Customizable Buttons

The C1, C2, and 5D buttons are customizable. Launch DJI Pilot 2 and enter camera view. Tap ... -> to configure the functions of these buttons. In addition, button combinations can be customized using the C1 and C2 buttons with the 5D button.

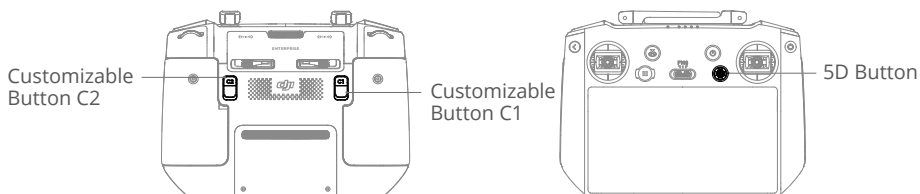

Combination Buttons

Some frequently-used features can be activated by using combination buttons. To use combination buttons, hold the back button and operate the other button in the combination. In actual use, enter the homepage of the remote controller and tap Guide to check all available combination buttons quickly.

Combination Operation	Function
Back Button + Left Dial	Adjust Brightness
Back Button + Right Dial	Adjust Volume
Back Button + Record Button	Record Screen
Back Button + Shutter Button	Screenshot
Back Button + 5D Button	Toggle up - Home; Toggle down - Shortcut settings; Toggle left - Recently opened apps

Optimal Transmission Zone

The signal between the aircraft and the remote controller is most reliable when the antennas are positioned in relation to the aircraft, as illustrated below.

The optimal transmission range is where the antennas face the aircraft, with the angle between the antennas and the back of the remote controller being 180° or 270°.

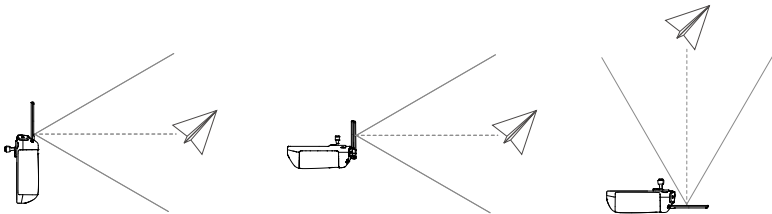

Linking the Remote Controller

The remote controller is already linked to the aircraft when purchased together as a combo. Otherwise, follow the steps below to link the remote controller and the aircraft after activation.

Method 1: Using Button Combinations

1. Power on the aircraft and the remote controller.
2. Press the C1, C2, and Record buttons simultaneously until the status LED blinks blue and the remote controller beeps.
3. Press and hold the power button of the aircraft for more than four seconds. The aircraft beeps twice after a short beep, and its battery level LEDs blink in sequence to indicate it is ready to link. The remote controller will beep twice, and its status LED will turn solid green to indicate linking is successful.

Method 2: Using DJI Pilot 2

1. Power on the aircraft and the remote controller.
2. Run DJI Pilot 2 and tap Link Remote Controller to link. The status LED of the remote controller blinks blue, and the remote controller beeps.
3. Press and hold the power button of the aircraft for more than four seconds. The aircraft beeps twice after a short beep, and its battery level LEDs blink in sequence to indicate it is ready to link. The remote controller will beep twice, and its status LED will turn solid green to indicate linking is successful.

 Make sure the remote controller is within 50 cm of the aircraft during linking.

Advanced Features

Calibrating the Compass

The compass may need to be calibrated after the remote controller is used in areas with electromagnetic interference. A warning prompt will appear if the compass of the remote controller requires calibration. Tap the warning prompt to start calibrating. In other cases, follow the steps below to calibrate your remote controller.

1. Power on the remote controller and enter the homepage.
2. Select Settings, scroll down, and tap Compass.
3. Follow the on-screen instructions to calibrate the compass.
4. A prompt will be displayed when the calibration is successful.

HDMI Settings

The touchscreen can be shared with a display screen via an HDMI cable.

The resolution can be set in Settings, Display, and then HDMI.

DJI Pilot 2 App

The DJI Pilot 2 app is specifically developed for enterprise users. Manual flight integrates a variety of professional features that make flying simple and intuitive. Flight task supports flight planning and autonomous operation of the aircraft, making your workflow much simpler and more efficient.

Homepage

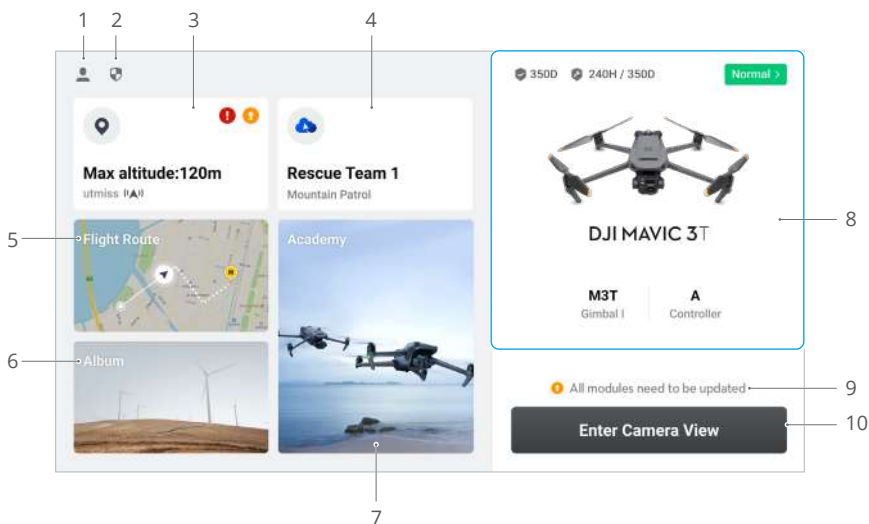

1. Profile

Tap to view flight records, download offline maps, manage GEO Zone unlocking, read help documentation, select a language, and view app information.

2. Data and Privacy

Tap to manage network security modes, set security codes, manage app cache, and clear DJI device logs.

3. GEO Zone Map

Tap to view the GEO Zone map, check offline whether the current operating area is in a restricted zone or authorization zone, and the current flyable altitude.

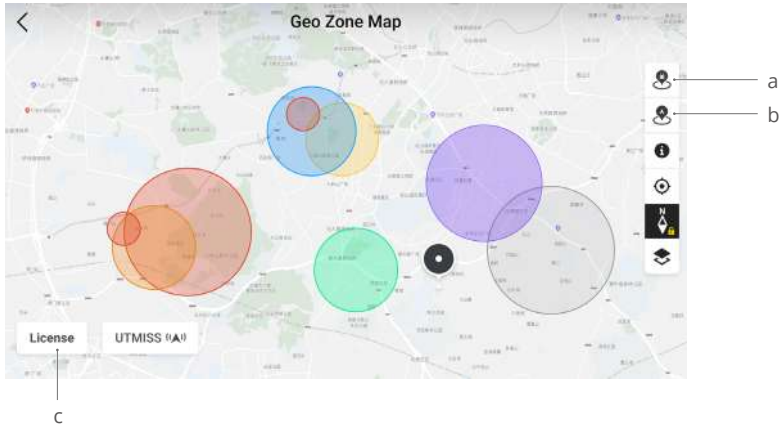

- a. Tap to update the GEO Zone database of the remote controller if an update is available.
- b. Tap to update the GEO Zone database of the aircraft if an update is available.
- c. Tap to enter and manage the unlocking certificate. If the aircraft is already connected to the remote controller, users can select the unlocking certificate directly to unlock the aircraft.

4. Cloud Service

Tap to enter the cloud service page, view the connection status of the cloud service, select the type of service, or switch from the currently connected service to another cloud service.

- a. If the DJI account logged in by the user has the DJI FlightHub 2 license, tap the cloud service on the app homepage to automatically log in to DJI FlightHub 2. DJI FlightHub 2 is a cloud-based integrated online management platform for aircraft, providing users with real-time aircraft monitoring and equipment and member management. For more information about DJI FlightHub 2, please visit <https://www.dji.com/flighthub-2>.
- b. If connected to the GB28181 service, GB28181 and its connection status will be displayed.
- c. If connected to a live service such as RTMP or RTSP, the corresponding live URL and connection status will be displayed.

 If the service is connected, the font will be displayed in dark black; if it is connecting, a connecting prompt will appear in the upper right corner of the cloud service; if it is offline or disconnected, an orange icon will appear in the upper right corner of the cloud service as an abnormal alert.

5. Flight Route

Tap to enter the flight route library. Users can create and view all flight tasks. Flight tasks can be imported and exported in batches to the remote controller or another external mobile storage device. If DJI FlightHub 2 is connected, you can also view all flight tasks sent from or upload local flight tasks to the cloud. Refer to the Flight Task section for more details.

6. Album

Tap to view your media all in one place. You can save the photos or videos to your remote controller. Note that photos and videos cannot be viewed if disconnected from the aircraft.

7. Academy

Tap to view Enterprise Product Tutorials, Flight Tips, and Case Studies, and download User Manuals to the remote controller.

8. Health Management System

Displays the health status of the aircraft, remote controller, and payload.

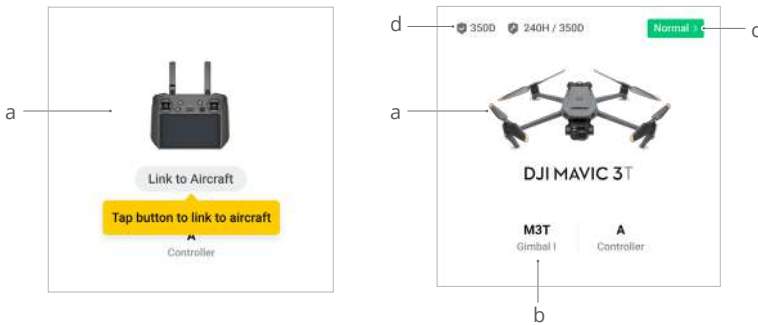

- a. If the current remote controller is not connected to the aircraft, the picture of the remote controller will be displayed. Tap to link the remote controller to the aircraft, and the aircraft model and picture will be displayed after it is connected.
- b. If the payload is abnormal, the payload name will appear in orange or red. Tap to view the error information on the payload.
- c. Tap to enter the Health Management System. The health status of the aircraft and the remote controller is displayed here. If it appears in green (normal), the aircraft is normal and can take off. If in orange (caution) or red (warning), the aircraft has an error and must be checked and cleared before takeoff. Read the Health Management System (HMS) section for more details.
- d. The maintenance information of the current aircraft is displayed here. If the aircraft has DJI Care Enterprise, its validity period will also be shown. Tap to view the device information, including cycle count, flight duration, flight history, activation time, flight mileage, etc.

9. Firmware Update Shortcut

If an update is necessary, a prompt will appear notifying the user that new firmware is available or a consistent firmware update is needed for the aircraft and remote controller.

Inconsistent firmware versions will affect flight safety. The app will prioritize consistent firmware updates. Tap the prompt to enter the firmware update page.

-  A consistent firmware update is required when the firmware versions of some modules of the aircraft are inconsistent with the compatible version of the system. In a typical consistent firmware update situation, the aircraft and remote controller will be updated to the latest version except for extra batteries. When these batteries are used, a prompt will appear requiring a consistent firmware update to ensure flight safety.

10. Enter Camera View

Tap to enter Preflight Check and switch between different modes of the camera view. Refer to Preflight Check and Camera View sections for more details.

Preflight Check

Tap Enter Camera View on the homepage of DJI Pilot 2 to enter Preflight Check.

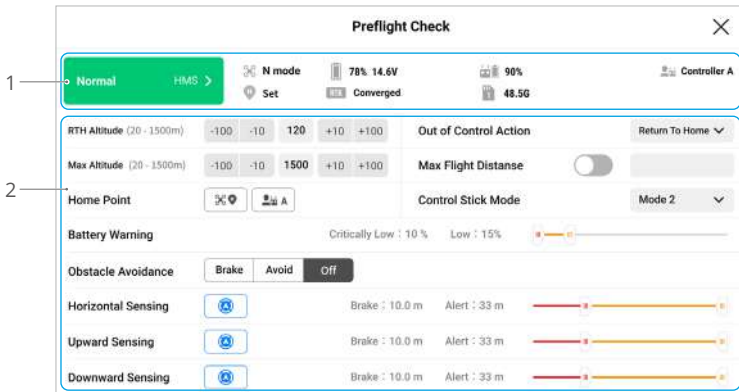

- View the aircraft's health information, flight mode, intelligent flight battery level, remote controller battery level, home point status, RTK status, and camera microSD card storage information.
- Customize the settings in the preflight checklist, such as RTH Altitude and Out of Control Action, update the Home Point, and set Customize Battery Warning and Obstacle Avoidance settings.

-  Users are advised to carefully conduct the preflight check according to the operation scenario and requirements before takeoff.
- Before executing a flight task, conduct a preflight check and verify the basic parameter information of the flight. Refer to the Flight Tasks section for details.

Camera View

Introduction

After tapping Enter Camera View on the home screen of DJI Pilot 2 and completing the Preflight Check, users will be directed to the camera view. The introduction below is based on the Mavic 3T Zoom mode.

 Features marked with * are only available on Mavic 3T.



1. Top Bar: displays the aircraft status, flight mode, signal quality, etc. Refer to the Top Bar section for more details.
2. Current Mode: displays the mode of the current camera view.
3. Camera Parameters: displays the camera's shooting/recording parameters.
4. Focus Mode: tap to switch between MF (manual focus), AFC (continuous autofocus), and AFS (single autofocus).
5. Storage Info: displays the remaining storage information of the aircraft microSD card. It shows the number of photos that can be shot or the remaining recording time.
6. Exposure Settings: Mavic 3T's tele and wide cameras support Auto and M exposure modes. Mavic 3E's tele camera supports Auto and M modes, and the wide camera supports Auto, S, A, and M modes. EV, AE lock, ISO, shutter, and other parameters can be configured accordingly in different exposure modes.
7. Link Zoom*: tap to synchronize the zoom setting in the IR and Wide modes. Users can view the linked zoom effect by enabling SBS in the IR camera view.
8. Camera Setting Menu: tap to enter the camera setting menu. The settings may vary depending on the camera type. Switch between different camera types to view the settings.

9. Photo/Video Mode: tap to switch between photo and video modes and select different shooting options.
 - a. Photo mode includes single, smart low-light, timed, and pano shots.
 - b. Different resolution options are available when shooting videos. Tele and wide cameras support recording at 3840×2160 and 1920×1080.
10. Shutter/Record Button: tap to take a photo or start or stop recording.
11. Playback: tap to view and download photos or videos stored on the aircraft microSD card.
12. Adjust Zoom: tap or drag to adjust the zoom in Zoom mode.
13. AR Projection: project information such as PinPoints, waypoints, and the home point in the camera view to improve flight situation awareness. Refer to the AR Projection section for more details.
14. Navigation Display: displays the aircraft flight speed, altitude, orientation, home point information, etc. Refer to the Navigation Display section for details.
15. Map View: tap to display the map view on the screen. Users can maximize or minimize the view.
16. Camera View Switch: tap to switch between the Wide, Zoom, and IR camera views.
17. Gimbal Mode: tap to recenter gimbal or tilt gimbal down.
18. PinPoint: tap to add the current aircraft location as a PinPoint. Tap and hold to open the PinPoint setting menu. Refer to the PinPoint section for more details.
19. Look At: after selecting a PinPoint, users can tap the Look At icon, and the camera will face the PinPoint.
20. Status of File Upload to Cloud: displays the file upload status from DJI Pilot 2 to DJI FlightHub 2 or the live stream connection status. Tap to view the details. If the DJI FlightHub 2 cloud service is enabled, users can quickly configure the media file upload settings.







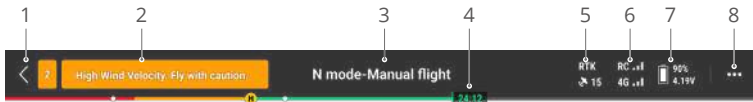

21. Flight Task Status: displays the progress of a flight task in the camera view. Tap the Pause/Resume button to pause or resume the task and tap the panel to view the flight task details.



Top Bar



1. Back: tap to return to the home screen of the DJI Pilot 2 app.
2. System Status Bar: indicates the aircraft flight status and displays various warning messages. If an alert appears during flight, it will be displayed in the system status bar and continue flashing. Tap to view the message, and the flashing will stop.
3. Flight Status:
 - a. The flight statuses include: standby, preparing to take off, ready to go, manual flight, mission flight, pano in progress, landing, vision positioning, etc.
 - b. When the aircraft is in vision positioning, standby, or manual flight status, the current flight mode will be displayed, including N, S, A, and T modes.
 - c. Tap to enter the Preflight Check view.
4. Battery Level Indicator Bar: displays the battery level and the remaining flight time of the Intelligent Flight Battery. Different battery levels are represented by different colors. When the battery level is lower than the warning threshold, the battery icon turns red, reminding the user to land the aircraft as soon as possible and replace the batteries.

5. **GNSS Positioning Status:** displays the number of searched satellites. RTK is only displayed after the RTK module is installed. When the RTK service is not enabled, the RTK icon is gray. When the RTK data is converged, the RTK icon will turn white. Tap the GNSS positioning status icon to view the RTK mode and GNSS positioning information.
6. **Signal Strength:** includes the video and control signal quality. Three green dots indicate strong signals, two yellow dots for medium signal strength, and one red dot for poor signal quality. If the signal is lost, it displays a disconnected icon in red.
7. **Intelligent Flight Battery Level:** displays the battery level of the aircraft. Tap to view battery level, voltage, and temperature.
8. **Settings:** tap to open the Settings menu to set the parameters of each module.
 - a.  **Flight Control System Settings:** includes flight mode switch, Home Point, return to home altitude, maximum altitude, distance limit, sensor status, out-of-control action, coordinated turn, and GNSS.
 - b.  **Sensing System Settings:** includes obstacle sensing switch, vision positioning switch, and precision landing switch.
 - c.  **Remote Controller Settings:** includes stick mode, customizable button settings, and remote controller calibration and linking.
 - d.  **Video Transmission Settings:** includes work frequency, channel mode, and video output type.
 - e.  **Intelligent Flight Battery Settings:** includes battery information, smart return-to-home, low battery warning thresholds, and number of days required for self-discharge.
 - f.  **Gimbal Settings:** only appears when RTK module is mounted. Include gimbal pitch settings, and gimbal auto calibration.
 - g.  **RTK Settings:** includes the RTK positioning function, RTK service type, and their corresponding settings and status displays.
 - h. **General Settings:** includes map selection, track display, unit setting, and lights setting.

Navigation Display

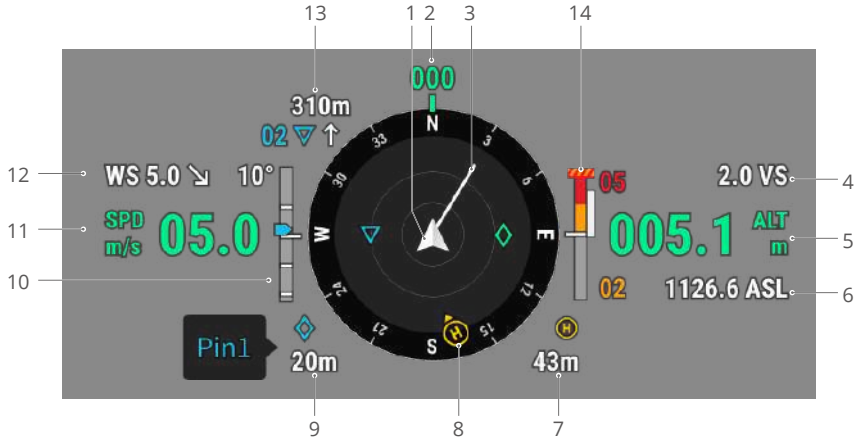

1. Aircraft: the attitude indicator will rotate as the aircraft changes its orientation.
2. Aircraft Orientation: displays the current orientation of the aircraft. The compass has 360° in total, and each direction is separated by 30°. The north corresponds to 0 and 360°. For example, when the aircraft points at the number 24, it represents that the aircraft yaws 240° in a clockwise direction starting north.
3. Aircraft Horizontal Speed Vector: the white line extending from the aircraft icon indicates the flight direction and how fast the aircraft is flying.
4. Vertical Speed (VS): displays the vertical speed of the aircraft when ascending or descending.
5. Altitude (ALT): displays the altitude of the aircraft relative to the takeoff point.
6. True Altitude (ASL): displays the altitude of the aircraft relative to the average sea level.
7. Distance from Home Point: displays the horizontal distance between the home point and the aircraft.
8. Home Point and Remote Controller Orientations:
 - a. Displays the position of the home point relative to the aircraft location. When the horizontal distance between the aircraft and the home point exceeds 16 m, the home point icon will still be displayed and stay on the edge of the Navigation Display.
 - b. When the relative distance between the home point and the remote controller is no more than 5 m, only the home point will be displayed. When the relative distance is more than 5 m, a blue dot will be displayed to indicate the position of the remote controller. When the horizontal distance between the remote controller and the aircraft exceeds 16 m, the remote controller icon will still be displayed and stay on the edge of the Navigation Display.

- c. The pointer on the blue dot can be used to indicate the direction the remote controller is facing when the compass of the remote controller is functioning properly. During the flight and when the signal is weak, the user can adjust the position of the remote controller and make the pointer of the blue dot face the direction of the aircraft to improve signal transmission.
9. PinPoint Information: displays the name of the PinPoint and the horizontal distance between the aircraft and the PinPoint when PinPoint is enabled.
 10. Gimbal Tilt.
 11. Aircraft Horizontal Speed.
 12. Wind Speed and Direction. The wind direction is relative to the aircraft.
 13. Waypoint Information: displays the name of the waypoint and the horizontal distance between the aircraft and the waypoint and indicates the ascending or descending trend of the immediate flight route during a flight task.
 14. Vertical Obstacle Indicator: once an obstacle is detected in the vertical direction, an obstacle bar icon will appear. When the aircraft reaches the warning distance, the icon will glow red and orange, and the remote controller will emit long beeping sounds. When the aircraft reaches the obstacle braking distance, the icon will glow red, and the remote controller will emit short beeping sounds. Both the obstacle braking distance and the warning distance can be set in DJI Pilot 2. Follow the prompted instructions in the app to set them. The white line shows the position of the aircraft in three seconds. The higher the vertical speed, the longer the white line.

Horizontal Obstacle Sensing Information:

- a. If the obstacle is within 16 m but has not reached the warning distance, the obstacle will be indicated by a green frame; when the obstacle is within 16 m and reaches the warning distance, the frame turns orange; and when the obstacle approaches the obstacle breaking distance, the frame turns red.



- b. When the obstacle sensing is disabled, OFF will be displayed. When the obstacle sensing is enabled, but the vision systems and the infrared sensing system are not available, NA will be displayed.



Wide Mode

This section mainly sets out the differences with the zoom mode. Refer to the Camera View section for more details.



Zoom Frame: after switching to the wide mode as the main view, the field of view and camera zoom ratio will be displayed on the zoom frame.

IR Mode*

This section mainly sets out the differences with the zoom mode. Refer to the Camera View section for more details.



1. **Palette:** displays the highest and lowest temperature measurement values of the current view. Tap to choose between different infrared temperature measurement palettes or enable the isotherm to set temperature measurement intervals. Note that if the measured area exceeds the maximum or minimum temperature measurement values of the current view, the setting will not take effect.
2. **Gain Modes:** high gain mode provides more accurate temperature measurements with a measurement range from -20° to 150° C (-4° to 302° F), while low gain mode supports a wider temperature measurement range of 0° to 500° C (32° to 932° F). Note that the range is only a theoretical value, and even though the thermal camera can measure temperatures beyond the range, the value may deviate substantially.
3. **Display Mode:** the infrared screen displays the infrared view alone by default. Tap to enable or disable side-by-side view. When enabled, both the infrared and zoom view will be displayed side by side.
4. **FFC Calibration:** tap to start FFC calibration. FFC calibration is a function of the thermal camera that optimizes image quality for easy observation of temperature changes.
5. **Zoom (Thermal Camera):** tap to adjust the digital zoom of the thermal camera with a maximum zoom capability of 28x. Tap and hold to zoom directly to 2x.

AR Projection

DJI Pilot 2 supports AR Projection of the following:

- a. **Home Point:** when the home point is beyond the range of the current view, it will still be displayed on the edge of the view. The aircraft can be turned toward the home point, following the direction of the arrow.
- b. **PinPoints:** a PinPoint appears bigger when near the aircraft and smaller when it is far. This allows the users to judge the distance between the PinPoint and the aircraft based on the size of the PinPoint. When a PinPoint selected is beyond the range of the current view, it will still be displayed on the edge of the view. The aircraft can be turned toward the PinPoint following the direction of the arrow.
- c. **Waypoints:** in a flight task, the two waypoints that the aircraft is about to pass will be projected on the camera view. The next waypoint to be reached will appear as a solid triangle marked with a serial number, while the subsequent waypoint will appear as a dotted triangle marked with a serial number.
- d. **ADS-B Manned Airplane:** when a manned airplane is detected nearby, it will be projected on the camera view. Ascend or descend the aircraft as soon as possible to avoid the manned airplane by following the prompted instructions.

Map View

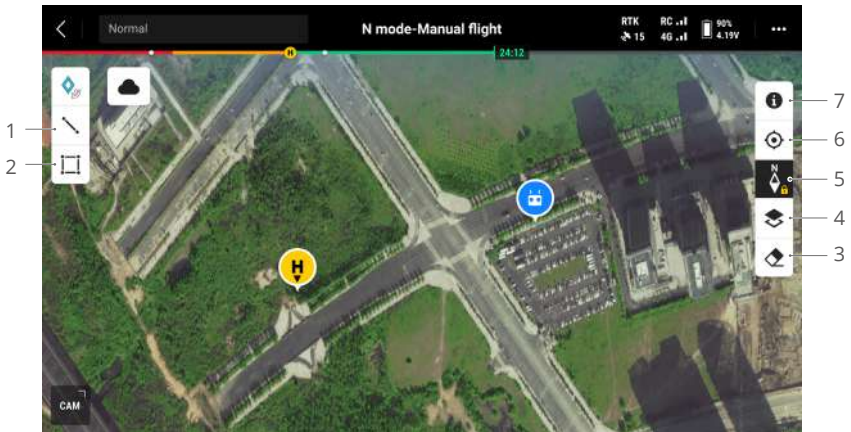

1. Tap to draw a line on the map.
2. Tap to draw an area on the map.
3. Tap to clear the flight route of the aircraft.
4. Map Layer Selection: tap to select a satellite or street map (standard mode) according to operational requirements.
5. Map Lock: when enabled, the map cannot be rotated; when disabled, the map can be rotated freely.
6. Recenter View: tap to quickly center the remote controller location in the view.
7. GEO Zone Map Layers: tap to view all GEO Zone layers and enable or disable the GEO Zones layer display on the map.

Annotation Management and Synchronization

PinPoint

For quick observation and information synchronization, PinPoint can be used to mark the aircraft location in the camera view or the center point of the map in the map view.

Steps to create a PinPoint in the camera view: adjust aircraft location, tap the PinPoint icon on the left side of the screen. PinPoint can be set based on the current aircraft location and includes the latitude, longitude, and altitude of the aircraft.



1. AR projection will be created for the PinPoint in the camera view. PinPoint size will be adjusted according to the distance between the aircraft and the PinPoint (big when near, small when far).
2. Selected PinPoint:
 - a. A small frame will appear around the PinPoint, indicating it is selected.
 - b. The lower left corner of the Navigation Display shows the horizontal distance from the PinPoint to the aircraft and the name of the PinPoint. The orientation of the PinPoint relative to the aircraft is also shown within Navigation Display.
 - c. If the selected PinPoint is outside the video transmission view, the PinPoint icon will stay on the edge of the screen, indicating the PinPoint orientation relative to the center of the view.
 - d. After selecting a PinPoint, the user can edit the name, color, latitude, longitude, and altitude of the PinPoint or drag the PinPoint on the map.
3. Tap **...** ->  to set functions of customizable buttons of the remote controller as add PinPoint, delete the selected PinPoint, or select the previous or next PinPoint. Users can quickly add and select PinPoints by pressing the buttons.

4. Switch to Map View:
 - a. The PinPoint and its name will be displayed on the map accordingly.
 - b. In map view, you can add a PinPoint by dragging the point to the crosshairs in the center of the map. The altitude is the current flight altitude of the aircraft.
 - c. Tap to select a PinPoint on the map to view the creator of the point, the distance between the PinPoint and aircraft, and the altitude, latitude, and longitude. Set the PinPoint as the Home Point, or edit or delete the PinPoint.

 PinPoint positioning is limited by factors such as the GNSS positioning accuracy. The latitude and longitude, horizontal distance, Navigation Display, and AR projection are provided for reference only.

Editing PinPoints



1. Press and hold the PinPoint icon on the touchscreen to bring up the settings panel of PinPoint. There are five color options for the PinPoint, and users are advised to set a color for each type of PinPoint based on the operation scenario.
2. Tap to expand the PinPoint list to view all PinPoints.
3. Set whether to display the newly created PinPoint in video transmission view.

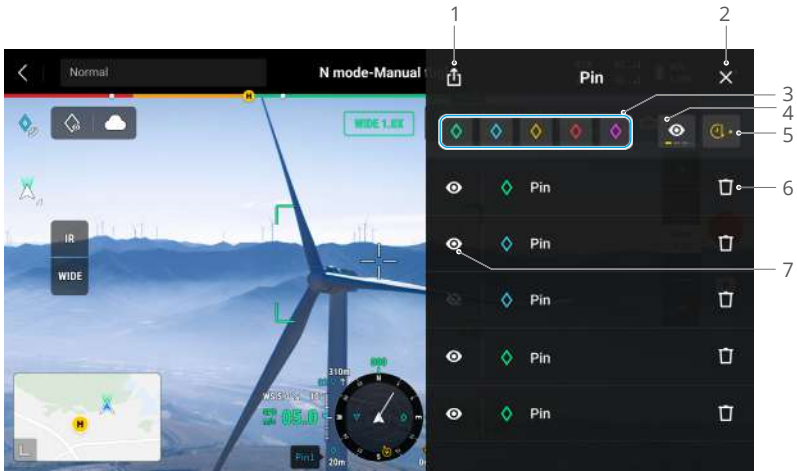

1. Tap to export all PinPoints to the local folder of the remote controller.
2. Tap to close the current panel.
3. Filter the PinPoints by color. Multiple colors can be selected, and PinPoints will be filtered by the colors selected.
4. Filter the PinPoints by their visibility in the video transmission view. The PinPoints can be filtered by any of these three criteria: show all PinPoints on this list; only show PinPoints that are visible in the video transmission view on this list; only show PinPoints that are not visible in the video transmission view on this list.
5. Tap to sort PinPoints in forward or reverse chronological or alphabetical order by their names.
6. Tap to delete the PinPoint.
7. Tap to enable or disable AR projection display for the PinPoint in video transmission view.

Line and Area Annotation Management

Users can draw lines and areas on the map to synchronize key information about roads and land.

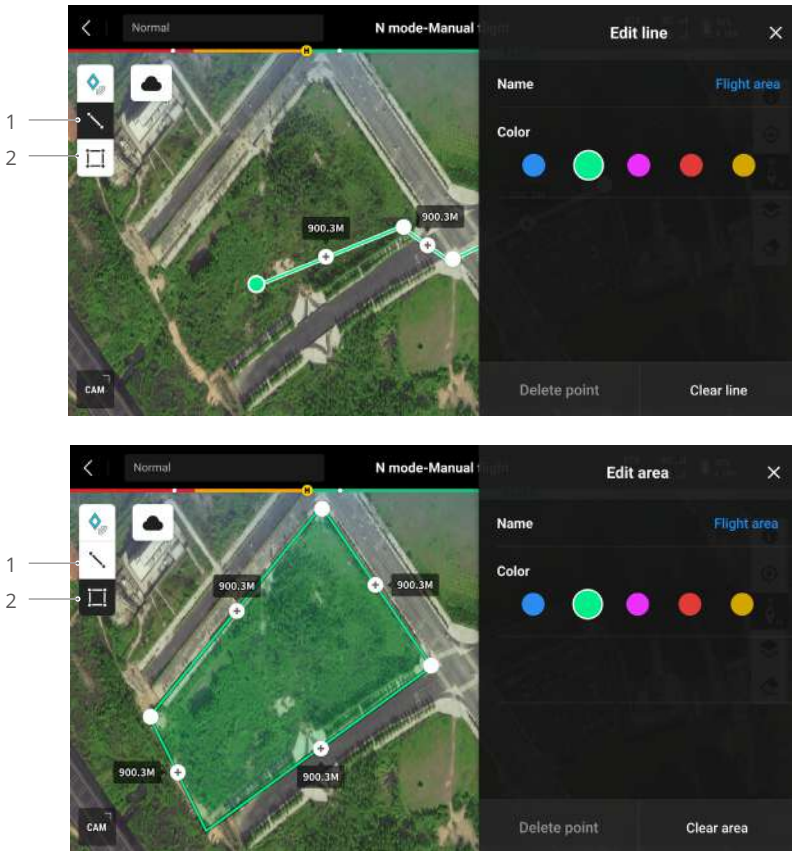

1. Tap to display the Edit Line view.
2. Tap to display the Edit Area view.

Annotation Sharing

For information sharing, the location of the PinPoint identified by the PinPoint feature can be synchronized with the camera view, Navigation Display, map view, and DJI FlightHub 2. It can be displayed on both camera and map views.

When connected to DJI FlightHub 2, the DJI Pilot 2 app and the point, line and area annotations of DJI FlightHub 2 can be synchronized with each other. Locations and annotations can be viewed on the remote controller and other devices logged into DJI FlightHub 2 for real-time sharing.

Flight Tasks

Tap on the home screen of DJI Pilot 2 to enter the flight route library. Users can view flight tasks or create a waypoint, mapping, oblique, or linear flight tasks. These four types of tasks are generated by the app. Meanwhile, waypoint flight tasks can also be created through Live Mission Recording.



Introduction

The flight task feature is illustrated below, with waypoint flights as an example.

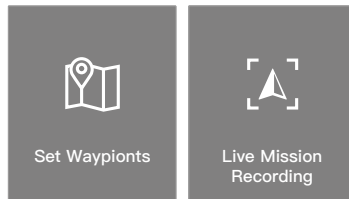

Waypoint flights can be planned in two ways: Set Waypoints or Live Mission Recording. Use Set Waypoints to create a route by adding and editing waypoints on the map. Use Live Mission Recording to create a route by adding waypoints when taking photos along the route.

Waypoint Flights - Set Waypoints

Tap Create a Route, Waypoint, and then Set Waypoints to create a flight route. Tap on the map to add waypoints, then configure route and waypoint settings.

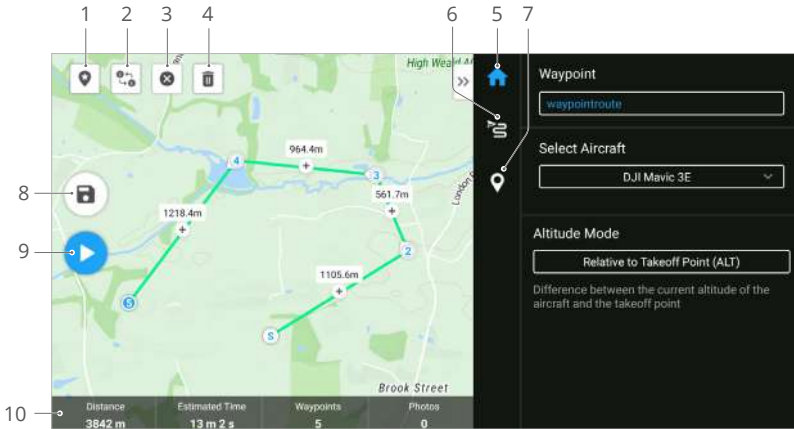

1. Point of Interest (POI): tap to enable the POI feature, and a POI will be displayed on the map. Drag to adjust its position. After a POI is added, the aircraft yaw can be set as facing the POI, so the aircraft nose always faces the POI during the task. Tap this icon again to disable the POI feature.
2. Reverse Flight Route: tap to reverse the flight route by swapping the start and endpoint. S refers to the start point.
3. Clear Waypoints: tap to clear all the added waypoints.
4. Delete Selected Waypoints: tap to delete the selected waypoints.
5. Parameters List: edit the route name, advanced flight route settings, and altitude mode. Set the aircraft type as Mavic 3E/3T.
6. Flight Route Settings: the settings are applied to the entire route, including safe takeoff altitude, ascend to start point, aircraft speed, aircraft altitude, aircraft yaw, gimbal control, waypoint type, and completion action. The settings will take effect on all waypoints of the route. If users want to set parameters of an individual waypoint, please refer to the next description.
7. Set Individual Waypoints: select a waypoint and set its parameters. Tap "<" or ">" to switch to the previous or next waypoint. The settings include aircraft speed, aircraft altitude, aircraft yaw mode, waypoint type, aircraft rotation direction, gimbal tilt mode, waypoint actions, longitude, and latitude.
8. Save: tap to save the current settings and generate a flight route.
9. Perform: tap the button and then check the settings and status of the aircraft in the Pre-flight Checklist. Tap to upload the flight route. Once the upload completes, tap the Start button to perform the current task.
10. Flight Route Information: displays the flight length, estimated flight time, waypoint, and photo quantity.

Waypoint Flights - Live Mission Recording

Tap Create a Route, Waypoint, and then Live Mission Rec to record photo information and the waypoint location of the aircraft.



1. Control the gimbal, adjust the zoom scale, and aim at the target. Tap to capture photos or press the C1 button of the remote controller to add a waypoint. The number of waypoints and photos will be added accordingly.
2. The number of planned waypoints.
3. The number of planned photos.
4. Tap to switch to Map View for editing or viewing.

Flight Tasks Editing

Enter the flight route library and select a created flight route for editing or viewing.



1. Tap to perform the current task.
2. Tap to enter the Flight Route Editing. The edits will be merged into the original route once saved.
3. Tap to enter the Set Waypoints page.

Health Management System (HMS)

The HMS system includes: DJI Maintenance Program, DJI Care Enterprise, Firmware Update, Manage Logs, Error Records, and Error Diagnosis.

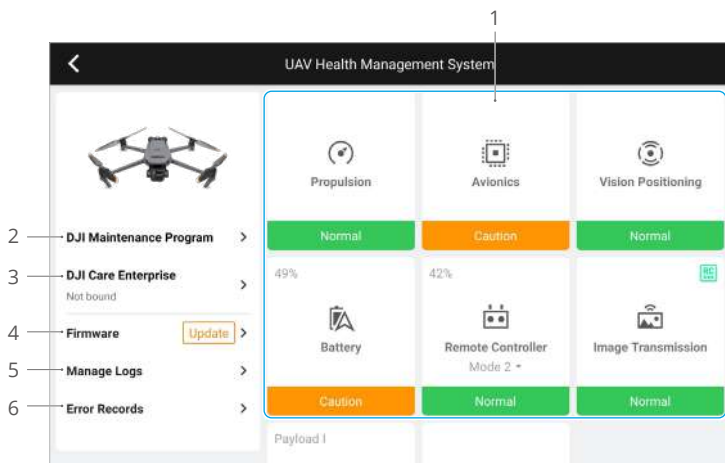

1. Error Diagnosis: for checking the current status of each aircraft module. Users can solve issues by following the corresponding prompted instructions.

Color	Status
Green	Normal
Orange	Caution
Red	Warning

2. DJI Maintenance Program: users can view historical flight data and refer to the maintenance manual to determine if maintenance is required.
3. DJI Care: relevant information can be viewed if the device is bound to DJI Care.
4. Firmware Update: tap to enter the Firmware Update page.
5. Manage Logs: displays the remote controller and aircraft log data of recent flights. Users can assist by exporting and saving the relevant logs locally or uploading them directly to the DJI Support cloud to help DJI Support solve issues.
6. Error Records: records aircraft issues to determine if any serious problem has occurred during usage. This helps users evaluate the stability of the aircraft and assist DJI Support in conducting aftersales analysis.

DJI FlightHub 2

Paired with the DJI FlightHub 2 cloud platform, the Mavic 3 Enterprise Series offer integrated air and ground handling with efficient operation management. The combined features of the two products make a wide range of real-time operations possible, including cloud mapping, point, line, and area annotations, flight information syncing, live viewing, media file upload or download, mutual access to statuses of multiple aircraft, flight tasks syncing, and real-time control from mobile devices.

For more details, refer to the DJI FlightHub 2 User Guide, which is available to download from the official DJI website <https://www.dji.com/flighthub-2/downloads>.

Appendix

Specifications

Aircraft

Weight (with propellers, without accessories) ^[1]	Mavic 3E: 915 g Mavic 3T: 920 g	
Max Takeoff Weight	1050 g	
Dimensions	Folded (without propellers): 221×96.3×90.3 mm Unfolded (without propellers): 347.5×283×107.7 mm	
Diagonal Distance	380.1 mm	
Max Ascent Speed	6 m/s (Normal Mode) 8 m/s (Sport Mode)	
Max Descent Speed	6 m/s (Normal Mode) 6 m/s (Sport Mode)	
Max Flight Speed (at sea level, no wind)	15 m/s (Normal Mode) 21 m/s (Sport Mode), 19 m/s (Sport Mode, EU)	
Max Wind Speed Resistance	12 m/s	
Max Take-off Altitude Above Sea Level (without payload)	6000 m	
Max Flight Time (no wind)	45 mins	
Max Hover Time (no wind)	38 mins	
Max Flight Distance	32 km	
Max Tilt Angle	30° (Normal Mode) 35° (Sport Mode)	
Max Angular Velocity	200°/s	
GNSS	GPS + Galileo + BeiDou + GLONASS (GLONASS is supported only when RTK module is enabled)	
Hovering Accuracy	Vertical: ±0.1 m (with Vision System); ±0.5 m (with GNSS); ±0.1 m (with RTK) Horizontal: ±0.3 m (with Vision System); ±0.5 m (with High-Precision Positioning System); ±0.1 m (with RTK)	
Operating Temperature Range	-10° to 40° C (14° to 104° F)	
Internal Storage	N/A	
Motor Model	2008	
Propeller Model	9453F Propellers for Enterprise	
Beacon	Built into the aircraft	
Gimbal	Mavic 3E	Mavic 3T
Stabilization	3-axis (tilt, roll, pan)	

Mechanical Range	Tilt: -135° to 100° Roll: -45° to 45° Pan: -27° to 27°	Tilt: -135° to 45° Roll: -45° to 45° Pan: -27° to 27°
Controllable Range	Tilt: -90° to 35° Pan: not controllable	
Max Control Speed (tilt)	100°/s	
Angular Vibration Range	±0.007°	
Wide Camera	Mavic 3E	Mavic 3T
Sensor	4/3 CMOS, Effective pixels: 20 MP	1/2" CMOS, Effective pixels: 48 MP
Lens	FOV: 84° Format Equivalent: 24 mm Aperture: f/2.8-f/11 Focus: 1 m to ∞ (with autofocus)	FOV: 84° Format Equivalent: 24 mm Aperture: f/2.8 Focus: 1 m to ∞
ISO Range	100-6400	100-25600
Shutter Speed	Electronic Shutter: 8-1/8000 s Mechanical Shutter: 8-1/2000 s	Electronic Shutter: 8-1/8000 s
Max Image Size	5280×3956	8000×6000
Still Photography Modes	Single: 20 MP Timed: 20 MP JPEG: 0.7/1/2/3/5/7/10/15/20/30/60 s JPEG+RAW: 3/5/7/10/15/20/30/60 s Smart Low-light Shooting: 20 MP Panorama: 20 MP (raw image); 100 MP (stitched image)	Single: 12 MP/48 MP Timed: 12 MP/48 MP JPEG: 2/3/5/7/10/15/20/30/60 s* * Shooting 48MP photo does not support 2s interval Smart Low-light Shooting: 12 MP Panorama: 12 MP (raw image); 100 MP (stitched image)
Video Resolution	H.264 4K: 3840×2160@30fps FHD: 1920×1080@30fps	
Bitrate	4K: 130Mbps FHD: 70Mbps	4K: 85Mbps FHD: 30Mbps
Photo Format	JPEG/DNG (RAW)	JPEG
Video Format	MP4 (MPEG-4 AVC/H.264)	
Supported File Formats	exFAT	
Tele Camera	Mavic 3E	Mavic 3T
Sensor	1/2" CMOS, Effective pixels: 12 MP	
Lens	FOV: 15° Format Equivalent: 162 mm Aperture: f/4.4 Focus: 3 m to ∞	
ISO Range	100-6400	100-25600
Shutter Speed	Electronic Shutter: 8-1/8000 s	
Max Image Size	4000×3000	
Photo Format	JPEG	
Video Format	MP4 (MPEG-4 AVC/H.264)	

Still Photography Modes	Single: 12 MP Timed: 12 MP JPEG: 0.7/1/2/3/5/7/10/15/20/30/60 s Smart Low-light Shooting: 12 MP	Single: 12 MP Timed: 12 MP JPEG: 2/3/5/7/10/15/20/30/60 s Smart Low-light Shooting: 12 MP
-------------------------	---	--

Video Resolution	H.264 4K: 3840×2160@30fps FHD: 1920×1080@30fps
------------------	--

Bitrate	4K: 130Mbps FHD: 70Mbps	4K: 85Mbps FHD: 30Mbps
---------	----------------------------	---------------------------

Digital Zoom	8× (56× hybrid zoom)
--------------	----------------------

Thermal Camera (Mavic 3T)

Thermal Imager	Uncooled VOx Microbolometer
----------------	-----------------------------

Pixel Pitch	12 μm
-------------	-------

Frame Rate	30 Hz
------------	-------

Lens	DFOV: 61° Format Equivalent: 40 mm Aperture: f/1.0 Focus: 5 m to ∞
------	---

Sensitivity	≤50 mk@F1.1
-------------	-------------

Temperature Measurement Method	Spot Meter, Area Measurement
--------------------------------	------------------------------

Temperature Measurement Range	-20° to 150° C (-4° to 302° F, High Gain Mode) 0° to 500° C (32° to 932° F, Low Gain Mode)
-------------------------------	---

Palette	White Hot/Black Hot/Tint/Iron Red/Hot Iron/Arctic/Medical/ Fulgurite/Rainbow 1/Rainbow 2
---------	---

Photo Format	JPEG (8-bit), R-JPEG (16-bit)
--------------	-------------------------------

Video Resolution	640×512@30fps
------------------	---------------

Bitrate	6Mbps
---------	-------

Video Format	MP4 (MPEG-4 AVC/H.264)
--------------	------------------------

Still Photography Modes	Single: 640×512 Timed: 640×512 JPEG: 2/3/5/7/10/15/20/30/60 s
-------------------------	---

Digital Zoom	28×
--------------	-----

Infrared Wavelength	8-14 μm
---------------------	---------

Infrared Temperature Measurement Accuracy	±2° C or ±2% (using the larger value)
---	---------------------------------------

Sensing

Type	Omnidirectional binocular vision system, supplemented with an infrared sensor at the bottom of the aircraft.
------	--

Forward	Measurement Range: 0.5-20 m Detection Range: 0.5-200 m Effective Sensing Speed: Flight Speed ≤15 m/s FOV: Horizontal 90°, Vertical 103°
---------	--

Backward	Measurement Range: 0.5-16 m Effective Sensing Speed: Flight Speed \leq 12 m/s FOV: Horizontal 90°, Vertical 103°
Lateral	Measurement Range: 0.5-25 m Effective Sensing Speed: Flight Speed \leq 15 m/s FOV: Horizontal 90°, Vertical 85°
Upward	Measurement Range: 0.2-10 m Effective Sensing Speed: Flight Speed \leq 6 m/s FOV: Front and Back 100°, Left and Right 90°
Downward	Measurement Range: 0.3-18 m Effective Sensing Speed: Flight Speed \leq 6 m/s FOV: Front and Back 130°, Left and Right 160°
Operating Environment	Forward, Backward, Lateral, and Upward: surface with a clear pattern and adequate lighting (lux >15) Downward: diffuse reflective surface with diffuse reflectivity >20% (e.g. walls, trees, people) and adequate lighting (lux >15)

Video Transmission

Video Transmission System	DJI O3 Enterprise Transmission
Live View Quality	Remote Controller: 1080p/30fps
Operating Frequency ^[2]	2.400-2.4835 GHz, 5.725-5.850 GHz
Transmitter Power (EIRP)	2.4 GHz: <33 dBm (FCC), <20 dBm (CE/SRRC/MIC) 5.8 GHz: <33 dBm (FCC), <14 dBm (CE), <30 dBm (SRRC)
Max Transmission Distance (unobstructed, free of interference) ^[3]	15 km (FCC), 8 km (CE/SRRC/MIC)
Max Transmission Distance (Obstructed) ^[4]	Strong Interference (dense buildings, residential areas, etc.): 1.5-3 km (FCC/CE/SRRC/MIC) Medium Interference (suburban areas, city parks, etc.): 3-9 km (FCC), 3-6 km (CE/SRRC/MIC) Low Interference (open spaces, remote areas, etc.): 9-15 km (FCC), 6-8 km (CE/SRRC/MIC)
Max Download Speed ^[5]	15 MB/s (with DJI RC Pro Enterprise)
Latency (depending on environmental conditions and mobile device)	Approx. 200 ms
Antenna	4 Antennas, 2T4R
Remote Controller	
Screen Resolution	1920×1080
Screen Size	5.5 inch
Screen Frame Rate	60fps
Screen Brightness	1000 nit
Touchscreen Control	10-point multi-touch
Battery	Li-ion (5000 mAh @ 7.2 V)

Charging Type	Recommended to be charged with the included DJI USB-C Power Adapter (100W) or USB charger at 12 V or 15 V
Charging Time	Approx. 1 hour 30 minutes (with the included DJI USB-C Power Adapter (100W) only charging the remote controller or a USB charger at 15 V) Approx. 2 hours (with a USB charger at 12 V)
Operating Time	Approx. 3 hours
Rated Power	12 W
Storage Capacity	Internal Storage (ROM): 64 GB Support microSD card to expand capacity
Video Output Port	Mini HDMI port
Operating Temperature Range	-10° to 40° C (14° to 104° F)
Storage Temperature	-30° to 60° C (-22° to 140° F) (within one month) -30° to 45° C (-22° to 113° F) (one to three months) -30° to 35° C (-22° to 95° F) (three to six months) -30° to 25° C (-22° to 77° F) (more than six months)
Charging Temperature	5° to 40° C (41° to 104° F)
GNSS	GPS + Galileo + GLONASS
Dimensions	Antennas folded and controller sticks unmounted: 183.27×137.41×47.6 mm Antennas unfolded and controller sticks mounted: 183.27×203.35×59.84 mm
Weight	Approx. 680 g
Model	RM510B
Video Transmission System	DJI O3 Enterprise Transmission
Max Transmission Distance (unobstructed, free of interference) ^[3]	15 km (FCC), 8 km (CE/SRRC/MIC)
Operating Frequency ^[2]	2.400-2.4835 GHz, 5.725-5.850 GHz
Transmitter Power (EIRP)	2.4 GHz: <33 dBm (FCC), <20 dBm (CE/SRRC/MIC) 5.8 GHz: <33 dBm (FCC), <14 dBm (CE), <23 dBm (SRRC)
Antenna	4 Antennas, 2T4R
Wi-Fi	
Protocol	802.11 a/b/g/n/ac/ax Support 2×2 MIMO Wi-Fi
Operating Frequency ^[2]	2.400-2.4835 GHz, 5.150-5.250 GHz, 5.725-5.850 GHz
Transmitter Power (EIRP)	2.4 GHz: <26 dBm (FCC), <20 dBm (CE/SRRC/MIC) 5.1 GHz: <26 dBm (FCC), <23 dBm (CE/SRRC/MIC) 5.8 GHz: <26 dBm (FCC/SRRC), <14 dBm (CE)
Bluetooth	
Protocol	Bluetooth 5.1
Operating Frequency	2.400-2.4835 GHz
Transmitter Power (EIRP)	<10 dBm

Storage

Supported Memory Cards Aircraft: U3/Class10/V30 or above is required. A list of recommended microSD cards can be found below.

Recommended microSD Cards

Remote Controller:
 SanDisk Extreme PRO 64GB V30 A2 microSDXC
 SanDisk High Endurance 64GB V30 microSDXC
 SanDisk Extreme 128GB V30 A2 microSDXC
 SanDisk Extreme 256GB V30 A2 microSDXC
 SanDisk Extreme 512GB V30 A2 microSDXC
 Lexar 667x 64GB V30 A2 microSDXC
 Lexar High-Endurance 64GB V30 microSDXC
 Lexar High-Endurance 128GB V30 microSDXC
 Lexar 667x 256GB V30 A2 microSDXC
 Lexar 512GB V30 A2 microSDXC
 Samsung EVO Plus 64GB V30 microSDXC
 Samsung EVO Plus 128GB V30 microSDXC
 Samsung EVO Plus 256GB V30 microSDXC
 Samsung EVO Plus 512GB V30 microSDXC
 Kingston Canvas Go! Plus 128GB V30 A2 microSDXC
 Kingston Canvas React Plus 128GB V90 A1 microSDXC

Aircraft:
 Sandisk Extreme 32GB V30 A1 microSDHC
 Sandisk Extreme PRO 32GB V30 A1 microSDHC
 SanDisk Extreme 512GB V30 A2 microSDXC
 Lexar 1066x 64GB V30 A2 microSDXC
 Kingston Canvas Go! Plus 64GB V30 A2 microSDXC
 Kingston Canvas React Plus 64GB V90 A1 microSDXC
 Kingston Canvas Go! Plus 128GB V30 A2 microSDXC
 Kingston Canvas React Plus 128GB V90 A1 microSDXC
 Kingston Canvas React Plus 256GB V90 A2 microSDXC
 Samsung PRO Plus 256GB V30 A2 microSDXC

Intelligent Flight Battery

Capacity 5000 mAh
Standard Voltage 15.4 V
Max Charging Voltage 17.6 V
Type LiPo 4S
Chemical System LiCoO2
Energy 77 Wh
Weight 335.5 g
Charging Temperature 5° to 40° C (41° to 104° F)

Charger

Input 100-240 V AC, 50-60 Hz, 2.5 A
Output Power 100 W
Output Max. 100 W (total)
 When both ports are used, the maximum output of one of the ports is 82 W. The charger will dynamically allocate the output power of the two ports according to the load power.

- [1] The standard weight of the aircraft (including the battery, propellers, and a microSD card). The actual product weight may vary due to differences in batch materials and external factors.
- [2] In some countries and regions, the 5.8 and 5.1GHz frequencies are prohibited, or the 5.1GHz frequency is only allowed for indoor use. Check local laws and regulations for more information.
- [3] Measured in an unobstructed environment free of interference. The above data shows the farthest communication range for one-way, non-return flights (with no payload) under each standard. During your flight, please pay attention to RTH reminders in the DJI Pilot 2 app.
- [4] Data tested under different standards in unobstructed environments with typical interference. Uses for reference purposes only and provides no guarantee as to the actual flight distance.
- [5] Measured in a laboratory environment with little interference in countries/regions that support both 2.4 GHz and 5.8 GHz. With footage saved on the officially recommended microSD cards. Download speeds may vary depending on actual conditions.

Firmware Update

Use DJI Pilot 2 or DJI Assistant 2 (Enterprise Series) to update the remote controller, aircraft, and other connected DJI devices.

Using DJI Pilot 2

1. Power on the aircraft and remote controller. Ensure the aircraft is linked to the remote controller, their battery levels are higher than 25%, and the remote controller is connected to the internet.
2. Run DJI Pilot 2. A prompt will appear on the homepage if new firmware is available. Tap to enter the Firmware Update view.
3. Tap Update All, and DJI Pilot 2 will download the firmware and update the aircraft and remote controller.
4. The aircraft and remote controller will automatically restart after the firmware update is completed.



- Make sure the remote controller is charged over 25% before updating. The update takes approximately 15 minutes (depending on network strength). Make sure the remote controller is connected to the internet during the whole update process.
 - The Intelligent Flight Battery installed on the aircraft will be updated to the latest firmware version.
-

Offline Update

An offline firmware package can be downloaded from the DJI official website to an external storage device such as a microSD card or U disk. Run DJI Pilot 2, tap HMS, and then Firmware Update. Tap Offline Update to select the firmware package of the remote controller or aircraft from the external storage device and tap Update All to update.

Using DJI Assistant 2 (Enterprise Series)

1. Connect the remote controller or aircraft to a computer separately, as the assistant software does not support updating multiple DJI devices at the same time.
2. Make sure the computer is connected to the internet and the DJI device is powered on with a battery level higher than 25%.
3. Launch DJI Assistant 2 and log in with a DJI account.
4. Tap the firmware update button on the left side.
5. Select the firmware version and tap to update. The firmware will be downloaded and updated automatically.
6. When the "Update successful" prompt appears, the update is completed, and the DJI device will restart automatically.



- The battery firmware is included in the aircraft firmware. Be sure to update all batteries.
 - Make sure that the battery levels of the aircraft and remote controller are higher than 25% before updating.
 - Make sure all DJI devices are connected properly to the computer during an update.
 - During the update process, it is normal for the gimbal to go limp, the aircraft status indicators to blink, and the aircraft to reboot. Wait patiently for the update to complete.
 - Make sure to keep the aircraft away from people and animals during a firmware update, system calibration, or parameter configuration.
 - For safety, make sure you are using the latest firmware version.
 - After the firmware update is completed, the remote controller and the aircraft may become disconnected. Re-link them if necessary.
-

WE ARE HERE FOR YOU



Contact
DJI SUPPORT

This content is subject to change.
Download the latest version from



<https://www.dji.com/mavic-3-enterprise/downloads>

If you have any questions about this document, please
contact DJI by sending a message to DocSupport@dji.com.

dji and MAVIC are trademarks of DJI.

Copyright © 2022 DJI All Rights Reserved.