



Wireless Door Detector

User's Manual







Foreword

General

This manual introduces the functions and operations of the wireless door detector (hereinafter referred to as the "door detector").

Safety Instructions

The following categorized signal words with defined meaning might appear in the manual.

Signal Words	Meaning
 DANGER	Indicates a high potential hazard which, if not avoided, will result in death or serious injury.
 WARNING	Indicates a medium or low potential hazard which, if not avoided, could result in slight or moderate injury.
 CAUTION	Indicates a potential risk which, if not avoided, could result in property damage, data loss, lower performance, or unpredictable result.
 TIPS	Provides methods to help you solve a problem or save you time.
 NOTE	Provides additional information as the emphasis and supplement to the text.

Revision History

Version	Revision Content	Release Time
V1.0.0	First release.	January 2021

About the Manual

- The manual is for reference only. If there is inconsistency between the manual and the actual product, the actual product shall prevail.
- We are not liable for any loss caused by the operations that do not comply with the manual.
- The manual would be updated according to the latest laws and regulations of related regions. For detailed information, see the paper manual, CD-ROM, QR code or our official website. If there is inconsistency between paper manual and the electronic version, the electronic version shall prevail.
- All the designs and software are subject to change without prior written notice. The product updates might cause some differences between the actual product and the manual. Please contact the customer service for the latest program and supplementary documentation.
- There still might be deviation in technical data, functions and operations description, or errors in print. If there is any doubt or dispute, please refer to our final explanation.
- Upgrade the reader software or try other mainstream reader software if the manual (in PDF format) cannot be opened.
- All trademarks, registered trademarks and the company names in the manual are the properties

of their respective owners.

- Please visit our website, contact the supplier or customer service if there is any problem occurred when using the device.
- If there is any uncertainty or controversy, please refer to our final explanation.

Important Safeguards and Warnings

The following description is the correct application of the device. Please read the manual carefully before use to prevent danger and property loss. Strictly conform to the manual during application and keep it properly after reading.

Operating Requirements

- Do not install the device in a humid, dusty or fuliginous area.
- Keep its horizontal installation, or install it at stable places, and prevent it from falling.
- Do not drip or splash liquids onto the device; do not put on the device anything filled with liquids to prevent liquids from flowing into the device.
- Do not dismantle the device arbitrarily.
- Transport, use and store the device within allowed humidity and temperature range.
- Do not place the accessory in the places close to radio interference sources, such as metal objects.

Power Requirement

- Use batteries according to requirements; otherwise, it might result in fire, explosion or burning of batteries.
- To replace batteries, use the same type of batteries.
- Use standard power adapter matched with this device. Otherwise, the user must undertake resulting personnel injuries or device damages.
- Use power supply that meets SELV (safety extra low voltage) requirements, and supply power with rated voltage that conforms to Limited Power Source in IEC60950-1. For specific power supply requirements, refer to device labels.
- Products with category I structure shall be connected to grid power output socket, which is equipped with protective grounding.
- Appliance coupler is a disconnecting device. During normal use, please keep an angle that facilitates operation.
- Use the accessories regulated by the manufacturer. The device must be maintained by professionals.

Table of Contents

Foreword	I
Important Safeguards and Warnings	III
1 Introduction	1
2 Checklist	2
3 Design	3
3.1 Appearance	3
3.2 Dimensions	4
4 Connecting to the Hub	5
5 Installation	6
6 Door Detector Configuration	7
6.1 Configuring the Door Detector	7
6.2 Viewing Status of the Door Detector	8
Appendix 1 Cybersecurity Recommendations	10

1 Introduction

Door detector is a wireless detector consisting of a sensor and a magnet that can send a signal to the hub and trigger an alarm when an armed door is opened. It can be set up via the DMSS App for iOS and Android phones.

2 Checklist

Figure 2-1 Checklist

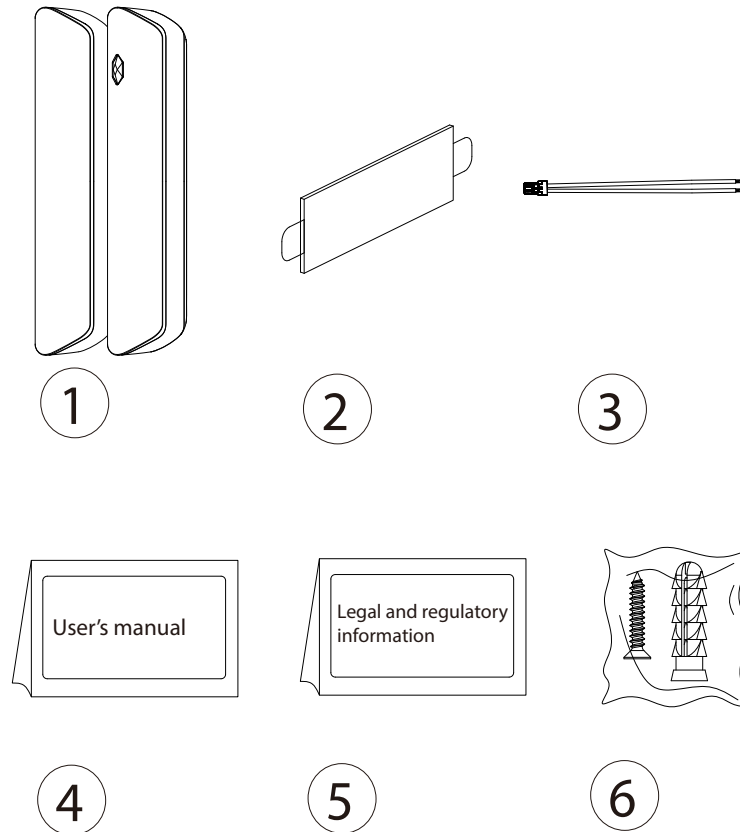

Table 2-1 Checklist

No.	Item Name	Quantity	No.	Item Name	Quantity
1	Door detector	1	4	User's manual	1
2	Double-sided adhesive tape	1	5	Legal and regulatory information	1
3	Cable	1	6	Screw package	2

3 Design

3.1 Appearance

Figure 3-1 Appearance

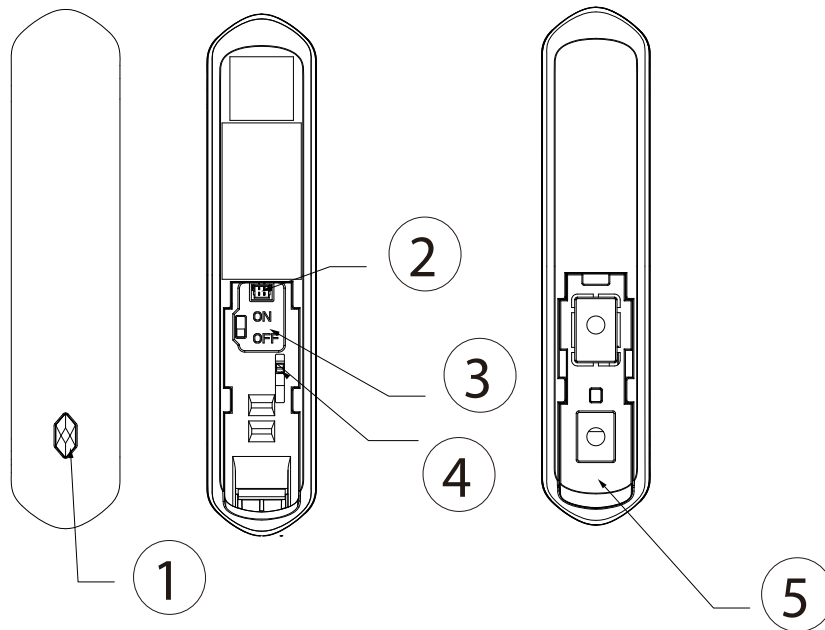
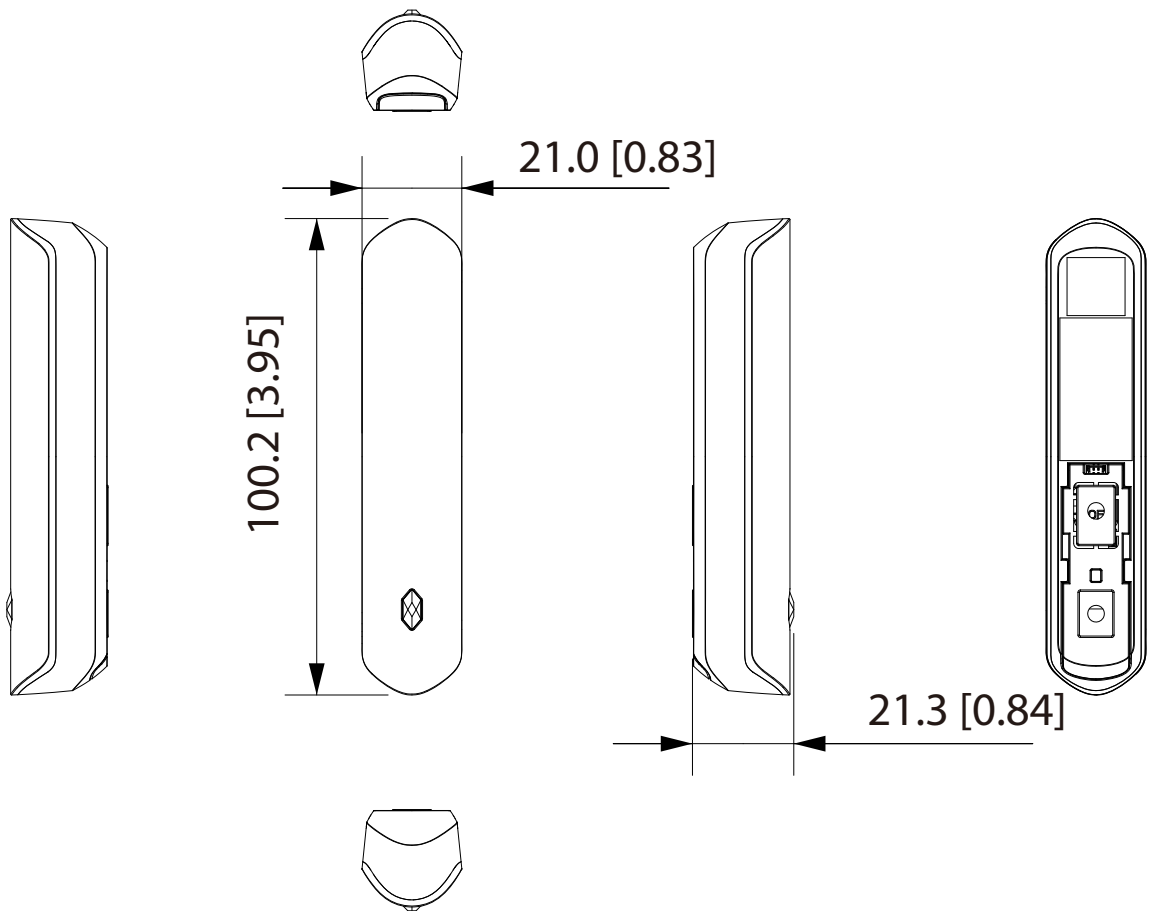

Table 3-1 Structure

No.	Name	Description
1	Indicator	<ul style="list-style-type: none"> Flashes green quickly: Pairing mode. Solid green: Alarm event is triggered.
2	Peripheral port	Connect the peripheral with the alarm cable.
3	On/Off button	Turn on or turn off the door detector.
4	Tamper button	The tamper mode of the accessory, which reacts to the detachment of the body.
5	Lid	<ul style="list-style-type: none"> Normal status: Lid closed. Abnormal status: Lid open.

3.2 Dimensions

Figure 3-2 Dimensions (mm[inch])





4 Connecting to the Hub

Prior to connection with the hub, install the DMSS App on your phone. Make sure that you have installed the latest version of the App. Interfaces and functions might vary with different added devices, and the actual interface shall prevail. This manual takes iOS as an example.



- Make sure that you have already created an account, and added hub to the application.
- Make sure that the hub has stable internet connection.
- Make sure that the hub is disarmed.

Step 1 Go to the hub interface, and then tap  to add the detector.

Step 2 Tap  to scan the QR code at the bottom of the door detector, and then tap **Next**.

Step 3 Tap **Next** after the door detector has been found.

Step 4 Follow on-screen instructions and switch the door detector to on, and then tap **Next**.

Step 5 Wait for the pairing.

Step 6 Customize the name of the door detector and select the area, and then tap **Completed**.

5 Installation

Prior to installation, connect the door detector to the hub and check the signal level at the installation location. We recommend installing the door detector in a place with the signal strength of at least 2 bars.



We recommend installing the door detector with expansion screws.

Figure 5-1 Installation

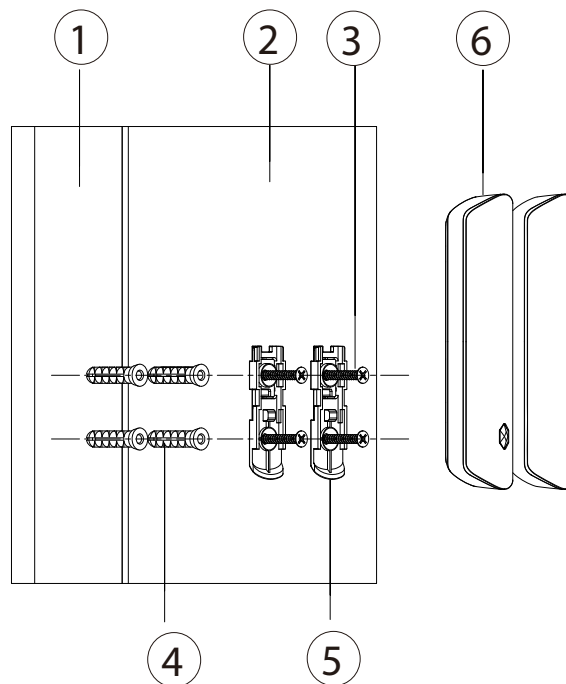

Table 5-1 Installation items

No.	Item name	No.	Item name
1	Door 1	4	Expansion bolt
2	Door 2	5	Attachment panel
3	ST3 × 18 mm self-tapping screw	6	Magnet

Step 1 Drill 4 holes in door 1 and door 2 according to the hole positions of the attachment panels.

Step 2 Put the expansion bolts into the holes.

Step 3 Align the screw holes on the plate with the expansion bolts.

Step 4 Fix the attachment panels with ST3 × 18 mm self-tapping screws.

Step 5 Put the door detector into the attachment panel from top to bottom.



6 Door Detector Configuration

You can view and edit general information of the door detector.

6.1 Configuring the Door Detector

On the **Hub** interface, select the door detector as needed from the accessory list, and then you can configure the parameters of the door detector.

Table 6-1 Door detector parameter description

Parameter	Description
Device Configuration	<ul style="list-style-type: none"> View device name, type, SN and device model. Edit device name, and then tap Save to save configuration.
Area	Select the area to which the door detector is assigned.
24 H Protection Zone	The accessory located in the 24 h protection zone is always active whether the security system is configured in the armed mode or not.
Home Mode	Enable the home mode, and then the selected accessories under the hub will be armed.
Delay Mode under Home Mode	<p>Enable the Delay Mode under Home Mode, the selected accessory under the hub will be armed and the alarm will not be triggered until the end of customized delay time.</p> <p> Only enable Home Mode first can Delay Mode under Home Mode take effect.</p>
Delay Time	<ul style="list-style-type: none"> The system provides you with time to leave or enter the armed zone without alarm. Select from 0 s to 120 s. <p> The arming mode will be effective after the delay time.</p>
External Detector Access	Connect the wired peripheral with the cable.
Alarm-speaker Linkage	When an alarm is triggered, the accessories will report the alarm events to the hub and alert with siren.
Alarm-video Linkage	When an alarm is triggered, the accessories will report the alarm events to the hub and then will be linked with videos.
Video Channel	Select the video channel as needed.
Signal Strength Detection	Test the current signal strength.
Detector Test	Detect whether the accessory works.

Parameter	Description
Transmit Power	<ul style="list-style-type: none"> Select from high, low, and automatic. The higher the transmission power, the farther the transmission and the higher power consumption.
Cloud Update	Update online.
Delete	Delete the online accessory.  Go to the Hub interface, select the accessory from the list, and then swipe left to delete it.

6.2 Viewing Status of the Door Detector















On the **Hub** interface, select the door detector as needed from the accessory list, and then tap  to view the status of the door detector.

Table 6-2 Status

Parameter	Value
Temperature	The temperature of the environment.
Signal Strength	The signal strength between the hub and the door detector. <ul style="list-style-type: none"> : Ultra low. : Low. : Moderate. : High. : No.
Battery Level	The battery level of the detector. <ul style="list-style-type: none"> : Fully charged. : Sufficient. : Moderate. : Insufficient.
Anti-tampering Status	Anti-tampering status of the door detector.
Online Status	Online and offline status of the door detector. <ul style="list-style-type: none"> : Online. : Offline.
Entrance Delay Time	Entrance and exit delay time.
Exit Delay Time	
Door Status	Open or close status of the door. <ul style="list-style-type: none"> : Open. : Close.

Parameter	Value
24 H Protection Zone Status	Active status of the 24 h protection zone. <ul style="list-style-type: none"><li data-bbox="667 293 836 322">● <input checked="" type="checkbox"/>: Enable.<li data-bbox="667 333 836 362">● <input type="checkbox"/>: Disable.
Program Version	The program version of the door detector.

Appendix 1 Cybersecurity Recommendations

Cybersecurity is more than just a buzzword: it's something that pertains to every device that is connected to the internet. IP video surveillance is not immune to cyber risks, but taking basic steps toward protecting and strengthening networks and networked appliances will make them less susceptible to attacks. Below are some tips and recommendations on how to create a more secured security system.

Mandatory actions to be taken for basic device network security:

1. Use Strong Passwords

Please refer to the following suggestions to set passwords:

- The length should not be less than 8 characters;
- Include at least two types of characters; character types include upper and lower case letters, numbers and symbols;
- Do not contain the account name or the account name in reverse order;
- Do not use continuous characters, such as 123, abc, etc.;
- Do not use overlapped characters, such as 111, aaa, etc.;

2. Update Firmware and Client Software in Time

- According to the standard procedure in Tech-industry, we recommend to keep your device (such as NVR, DVR, IP camera, etc.) firmware up-to-date to ensure the system is equipped with the latest security patches and fixes. When the device is connected to the public network, it is recommended to enable the "auto-check for updates" function to obtain timely information of firmware updates released by the manufacturer.
- We suggest that you download and use the latest version of client software.

"Nice to have" recommendations to improve your device network security:

1. Physical Protection

We suggest that you perform physical protection to device, especially storage devices. For example, place the device in a special computer room and cabinet, and implement well-done access control permission and key management to prevent unauthorized personnel from carrying out physical contacts such as damaging hardware, unauthorized connection of removable device (such as USB flash disk, serial port), etc.

2. Change Passwords Regularly

We suggest that you change passwords regularly to reduce the risk of being guessed or cracked.

3. Set and Update Passwords Reset Information Timely

The device supports password reset function. Please set up related information for password reset in time, including the end user's mailbox and password protection questions. If the information changes, please modify it in time. When setting password protection questions, it is suggested not to use those that can be easily guessed.

4. Enable Account Lock

The account lock feature is enabled by default, and we recommend you to keep it on to guarantee the account security. If an attacker attempts to log in with the wrong password several times, the corresponding account and the source IP address will be locked.

5. Change Default HTTP and Other Service Ports

We suggest you to change default HTTP and other service ports into any set of numbers between 1024~65535, reducing the risk of outsiders being able to guess which ports you are using.

6. Enable HTTPS

We suggest you to enable HTTPS, so that you visit Web service through a secure communication channel.

7. MAC Address Binding

We recommend you to bind the IP and MAC address of the gateway to the device, thus reducing the risk of ARP spoofing.

8. Assign Accounts and Privileges Reasonably

According to business and management requirements, reasonably add users and assign a minimum set of permissions to them.

9. Disable Unnecessary Services and Choose Secure Modes

If not needed, it is recommended to turn off some services such as SNMP, SMTP, UPnP, etc., to reduce risks.

If necessary, it is highly recommended that you use safe modes, including but not limited to the following services:

- SNMP: Choose SNMP v3, and set up strong encryption passwords and authentication passwords.
- SMTP: Choose TLS to access mailbox server.
- FTP: Choose SFTP, and set up strong passwords.
- AP hotspot: Choose WPA2-PSK encryption mode, and set up strong passwords.

10. Audio and Video Encrypted Transmission

If your audio and video data contents are very important or sensitive, we recommend that you use encrypted transmission function, to reduce the risk of audio and video data being stolen during transmission.

Reminder: encrypted transmission will cause some loss in transmission efficiency.

11. Secure Auditing

- Check online users: we suggest that you check online users regularly to see if the device is logged in without authorization.
- Check device log: By viewing the logs, you can know the IP addresses that were used to log in to your devices and their key operations.

12. Network Log

Due to the limited storage capacity of the device, the stored log is limited. If you need to save the log for a long time, it is recommended that you enable the network log function to ensure that the critical logs are synchronized to the network log server for tracing.

13. Construct a Safe Network Environment

In order to better ensure the safety of device and reduce potential cyber risks, we recommend:

- Disable the port mapping function of the router to avoid direct access to the intranet devices from external network.
- The network should be partitioned and isolated according to the actual network needs. If there are no communication requirements between two sub networks, it is suggested to use VLAN, network GAP and other technologies to partition the network, so as to achieve the network isolation effect.
- Establish the 802.1x access authentication system to reduce the risk of unauthorized access to private networks.
- Enable IP/MAC address filtering function to limit the range of hosts allowed to access the device.

ENABLING A SAFER SOCIETY AND SMARTER LIVING

ZHEJIANG DAHUA VISION TECHNOLOGY CO., LTD.

Address: No.1199 Bin'an Road, Binjiang District, Hangzhou, P. R. China | Website: www.dahuasecurity.com | Postcode: 310053

Email: overseas@dahuatech.com | Fax: +86-571-87688815 | Tel: +86-571-87688883