

AYC-W6500
Integrated Reader and Controller

Installation & Operating Guide



December 2009

ROSSLARE
SECURITY PRODUCTS

Table of Contents

1. General Information	3
1.1 Introduction.....	3
1.2 Reader/Controller Types	4
1.3 Unpacking the Equipment	4
1.4 Ancillary Equipment	4
2. Technical Specifications	5
2.1 Key Features	6
3. Installation	8
3.1 Mounting the AYC-W6500	8
3.2 Wiring Instructions	9
4. Reader Functionality	13
4.1 Modes of Operation	13
4.2 Enrolling a Fingerprint	15
4.3 Programming the AYC-W6500	16
5. Controller Functionality	31
5.1 Introduction.....	31
5.2 Modes of Operation	32
5.3 Enrolling a Fingerprint	33
5.4 Door Alarms	34
5.5 Case and Back Tamper	34
5.6 Request to Exit (REX) Function.....	35
5.7 PS-Ax5T/TU or PS-Cx5T/TU Units	35
5.8 Programming the AYC-W6500	35
Appendix A. Limited Warranty	61
Appendix B. Technical Support	63

1. General Information

The AYC-W6500 is an integrated reader and controller, designed for use either as a stand-alone unit or in conjunction with Rosslare's BioTrax software system.

The unit automatically determines whether to function as a reader or as a controller.

1.1 Introduction

When the AYC-W6500 unit is connected to a standard access controller, then it functions as a reader.

If the unit is connected to one of Rosslare's intelligent power supplies; PS-A15T/TU, PS-C15T/TU, PS-A25T/TU, or PS-C25T/TU it functions as a secured controller.

When the unit operates as a reader, transmission of a Card ID or PIN ID entered by the user will take place only after successful fingerprint verification.

When the unit operates as a controller, door output will open after a Card ID or PIN ID is entered followed by successful fingerprint verification.

For information on how the unit functions as a reader, see Reader Functionality on page 13.

For information on how the unit functions as a controller, see Controller Functionality on page 31.

The AYC-W6500 can optionally work with BioTrax software. For more information on BioTrax software see the BioTrax Software Manual.

The unit is suitable for indoor mounting, accepts up to 500 users, and allows entry via a personal identification number (PIN) and/or by presenting a proximity card.

PIN codes may be restricted to a single set length of 4, 5 or 6 digits. Alternatively, the PIN codes can be a variable length of between 4 and 8 digits.

Using this Manual

This manual contains the following information:

- Installation
- Wiring instructions
- Operation Instructions

1.2 Reader/Controller Types

Upon power-on reset, the AYC-W6500 searches for the presence of a Rosslare PS-Ax5T/TU or PS-Cx5T/TU intelligent power supply.

If the power supply is detected, then the AYC-W6500 is automatically configured as a secure access control unit. Two short beeps (one second apart) are generated on power-on reset. If the power supply is not detected, it is automatically configured as a reader indicated by one short beep generated on power-on reset.

1.3 Unpacking the Equipment

Before you begin, please confirm you have received all the items listed below. If you find any items missing, contact your local Rosslare distributor immediately.

- One AYC-W6500 unit
- CD with the BioTrax software
- Installation kit
- Installation and operating instructions
- Software manual
- RS-232 cable

1.4 Ancillary Equipment

The following equipment is required to complete installation:

Reader

- Compatible host controller (not supplied)—UL listed access control unit, i.e., AC-225

Controller

- PS-Ax5T/TU and PS-Cx5T/TU (x stands for 1 or 2) intelligent power supply (for controller applications only, optional)—this unit connects to the following:
 - Electric lock output mechanism or a magnetic lock device, which implements fail safe (power to lock) or fail secure (power to open) functions.
 - Request to Exit (REX) button—normally open type. Switch is closed when pressed.
 - General input switch (e.g. door monitor contact).
 - Auxiliary output.

Rosslare accessories can be found at www.rosslaresecurity.com.

Technical Specifications

2. Technical Specifications

Electrical Characteristics

Power supply type	Linear type – recommended
Operating voltage range	10 - 16VDC (provided by the PS-Ax5T/TU and PS-Cx5T/TU when used as a controller)
Input current standby (12VDC)	140mA
Input current max (16VDC)	330mA
Reader outputs	Open collector, 5V termination
Tamper output	Open Collector Output
Auxiliary input (LED_CTL)	Dry contact, Normally Open. 0-5V

Operational Characteristics

Cable distance to host controller	Up to 500ft (150 meters) using an 18AWG cable
Operation Modes	Normal PIN or Proximity Card + Fingerprint Verification
	Secure Proximity Card + PIN code + Fingerprint Verification
Fingerprint Sensor	Capacitive biometric fingerprint sensor
No. of Users	500
Fingerprint Templates	Up to 1910 templates (two templates per fingerprint)
Verification Time	Less Than 1.5 seconds
Verification Method	1:1
Max proximity card read range*	3 Inches (7.5 cm)
Proximity card modulation	ASK at 125 KHz
Proximity card compatibility	EM cards
Card Transmit format (Reader)	26-bit Wiegand, or Clock & Data
Keypad	3 x 4 Key, Backlit
Keypad Transmit Format (Reader)	Programmable PIN code formats
LED reader status	Two Tri-colored LEDs

Operational Characteristics

Communication	RS-232 (to host computer)
Sensor ESD Rating	±15kV (Fingerprint Sensor)

Environmental Characteristics

Operating Environment	-5°C to +60°C, 10% - 90% RH (Non-Condensing), Indoor
------------------------------	--

Size and Weight Characteristics

Dimensions:	5.16" x 4.92" x 1.38" (131x125x35 mm)
Weight:	270g (0.595lbs)

*Measured using Rosslare proximity card (AT-14) or equivalent. Range also depends on the electrical environment and proximity to metal.

2.1 Key Features

The AYC-W6500 system includes the following key features:

- Built-In Proximity Card Reader (125 KHz ASK Modulation)
- Built-in Fingerprint Capacitive Sensor
- PIN, Proximity card and a fingerprint identification per user
- Accurate fingerprint verification, using two fingerprint templates for each user.
- 1 second verification time
- BioTrax™ PC software for complete management of the fingerprint database and fast configuration of the reader
- Up to 500 users
- Optical back tamper sensor and open controller tamper output
- Programmable keypad backlight options (On, Off, 10 second activation on key touch)
- Internal buzzer provides audible interface feedback
- Two tri-color Reader status LED reader status
- Two user levels
 - Normal User
 - Secure User
- Code Search feature that helps make maintaining user codes easier

Technical Specifications

- Plastic case for indoor use
- Comes with mounting template for easier installation
- Comes with an installation kit that includes a security screw and a security screw tool

Reader and Controller Features

Additional features for the AYC-W6500 series include the following:

Reader

- Programmable keypad transmission format
- Programmable input (LED_CTL) can control either the operation of the LED or the unit's operation mode.
- Programmable facility code
- Two Modes of Operation
 - Normal Mode
 - Secure Mode
- Built-In Proximity Card Reader (125 KHz ASK Modulation)
- Programmable Proximity Card Transmission Format
 - Clock & Data
 - 26-Bit Wiegand Controller
- Bi-directional secure communication with AC-Ax5T or PS-Cx5T secured power supply
- Two User Levels
 - Normal User
 - Secure User
- Request-to-Exit (REX) signal from PS-Ax5T/TU or PS-Cx5T/TU power supply
- Two Modes of Operation
 - Normal Mode
 - Secure Mode
- Programmable Lock Output Release, Siren, and Alarm Delay timers
- Programmable auxiliary input (controlled via the PS-A25T or PS-C25T power unit)

3. Installation

The AYC-W6500 is easy to install and fits all standard US and UK gang boxes.

3.1 Mounting the AYC-W6500

Before connecting the AYC-W6500, mount it on an appropriate surface. In most circumstances, the unit should be located at approximately shoulder height.

To Mount the Unit on a Surface

1. Remove the unit's front cover, using the security spline key.
The screw holes on the back plate are now visible.
2. Select an approximate location for the unit.
3. Peel off the back of the self-adhesive installation template and attach the template to the required location.
4. Using the template as a guide, drill four holes into the surface. The required hole size is marked on the template.

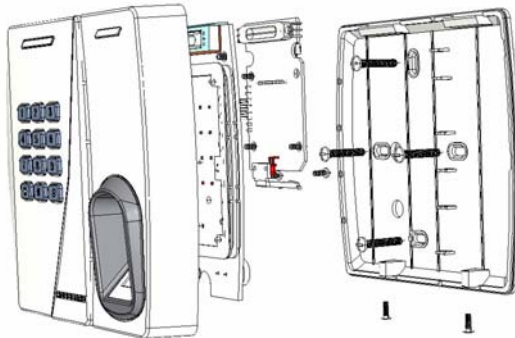

Figure 1 AYC-W6500 Assembly and mounting

5. Drill an additional 7/16" (10mm) hole for the cable.
When installing the unit on a metallic surface, cover the inside of the hole with a grommet or electrical tape.
6. When operating the unit as a reader, route the unit's interface cable to the access controller.
When operating the unit as a secured controller, route the unit's interface cable to the PS-Ax5T/TU or PS-Cx5T/TU power supply.
Rosslare recommend using a regulated linear power supply.
7. Screw the back plate into the surface. Ensure the screws are the size specified on the installation template.

Installation



Note:

It is also possible to mount the unit using any strong epoxy glue. Apply the glue and then hold the unit's back plate firmly in place until the glue dries.

8. Re-attach the unit's front cover.

3.2 Wiring Instructions

The unit is supplied with a 16-inch pigtail, having a 10-conductor cable.

To Connect the Unit to the Controller

1. Prepare the unit's cable by cutting the cable jacket back 1¼ inches and strip the wire ½ inch.
2. Prepare the controller cable by cutting the cable jacket back 1¼ inches and strip the wire ½ inch.
3. Splice the unit's pigtail wires to the corresponding controller wires and cover each connection.

Refer to the wire color table below, and to the wiring diagrams provided on the following pages.

Controller	Reader	Color	Functionality
5-16 VDC	5-16 VDC	Red	+DC Input
Shield / Ground	Shield / Ground	Black	Ground
C1	Data 1	White	Communication
C2	Data 0	Green	Communication
LED_CTL	LED_CTL	Brown	Auxiliary Input
Tamper	Tamper	Purple	Tamper
Tx	Tx	Blue	RS-232 Transmit
Rx	Rx	Grey	RS-232 Receive
Ground	Ground	Orange	RS-232 Ground
N/A	N/A	Yellow	N/A

4. If the tamper output is used, connect the purple wire to the correct input on the controller when used as reader, or to the zone input of an intruder alarm system when used as a controller.
5. Trim and cover all unused conductors.



Note:

- The individual wires from the unit are color-coded according to the Wiegand standard.
- When using a separate power supply for the unit, this

supply and that of the controller must have a common ground.

- The unit's cable shield wire should preferably be attached to an earth ground, or a signal ground connection at the panel, or power supply end of the cable. This configuration is best for shielding the unit cable from external interference



Note:

Actual wiring should be according to the power supply's terminal blocks, all figures in this section are schematic for reference only.

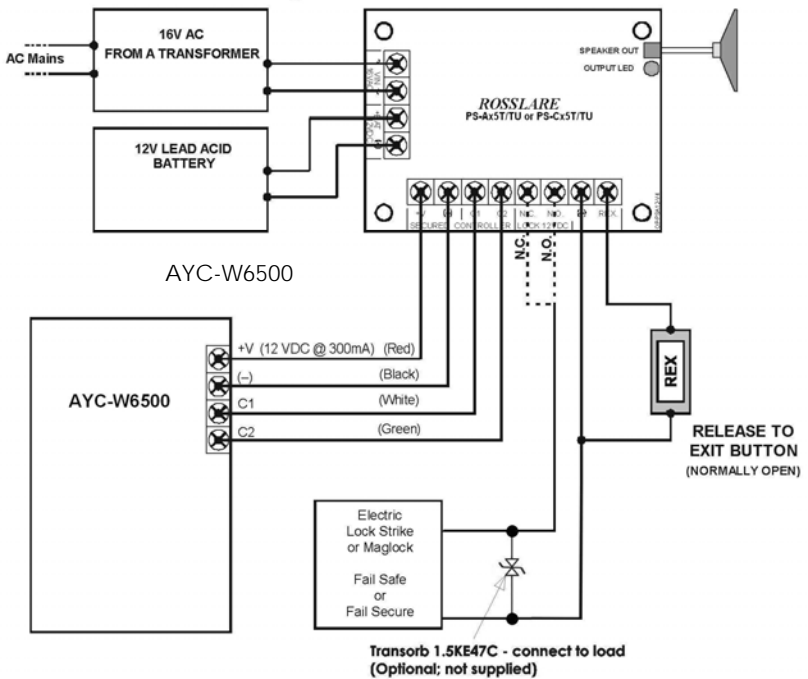

Figure 2: Controller Application Wiring Diagram #1

Wiring diagram #2 (below) shows the door monitor and the tamper input to an external alarm system.

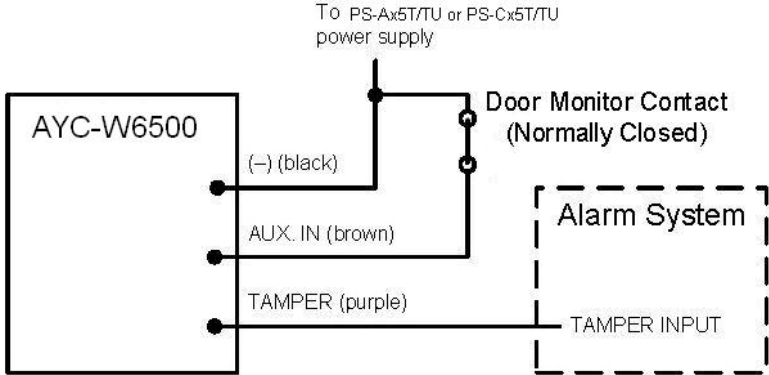

Figure 3: Controller Application Wiring Diagram #2

Wiring diagram #3 shows the auxiliary signal input to the external alarm system.

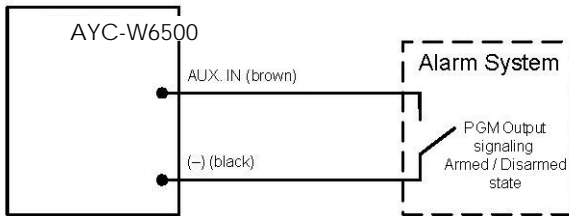

Figure 4: Controller Application Wiring Diagram #3

The wiring diagram #4 (below) shows the wiring for the reader application.

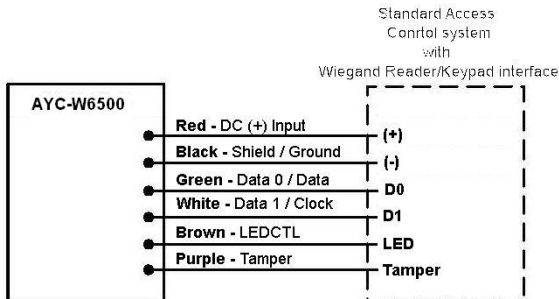

Figure 5: Reader Application Wiring Diagram #3

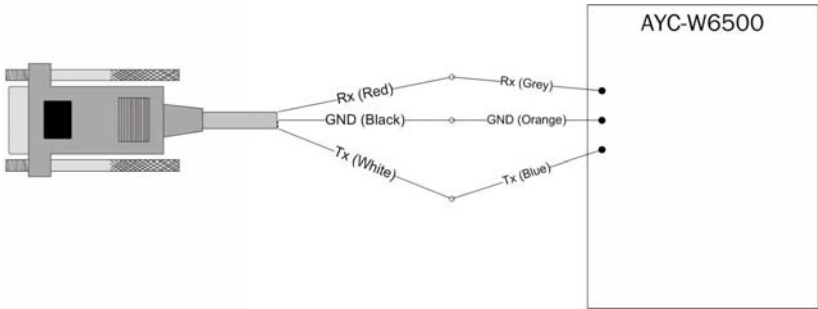

Figure 6: PC Connection Using RS-232 Cable

4. Reader Functionality

The AYC-W6500 series can function both as a reader and as a controller. When the unit is connected to a standard access controller, it functions as a reader. When the unit is reset and is operating as a reader, it generates one beep. The keypad can be programmed to output four different data formats.

The AYC-W6500 has two LEDs, one which indicates the status of the unit, and one which indicates the status of the fingerprint reader.

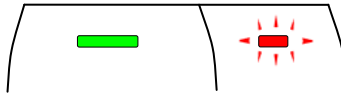

Figure 7: The Unit Status LED and the Fingerprint Reader LED

The following explains how the AYC-W6500 functions as a reader.

4.1 Modes of Operation

The AYC-W6500 has two modes of reader operation:

1. Normal Mode

- Reader Status LED is red 

Normal Mode is the default mode. In Normal Mode, the door is locked until a PIN code or card and the user's finger is presented to the unit.

To use the unit in Normal Mode:

- Present your proximity card or enter the PIN code.
- The fingerprint reader LED flashes green 
- Place your finger on the sensor for verification.
- If your fingerprint details are not found in the unit, the fingerprint



reader LED flashes orange 

2. Secure Mode

- Reader status LED flashes red 

In Secure Mode, first present a Proximity card, then enter a PIN code. Next, present a fingerprint for verification to gain entry.

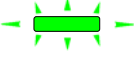
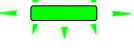
To use the unit in Secure Mode:

- Present your proximity card.
- The Reader status LED flashes green  for ten seconds.
- While the Reader status LED is flashing, enter the PIN code.
- The reader status LED stops flashing and stays alight. The fingerprint reader LED flashes green .
- Place your finger on the sensor for verification.
- If your fingerprint details are not found in the unit, the fingerprint reader LED flashes orange .

Changing the Operation Mode



The unit can be easily toggled between Normal and Secure Modes, directly from the keypad.

**Note:**

It is also possible to control the operation mode from the auxiliary input. See "Controlling Operation by Auxiliary Input", page 24.



Changing from Normal Mode to Secure Mode

The default factory setting for Normal / Secure code is 3838.

1. Enter the Normal / Secure code.
 - Reader status LED flashes green .
2. Press the "#" key to confirm the mode change.
 - Reader status LED flashes red .

Changing from Secure Mode to Normal Mode



The default factory setting for Normal / Secure code is 3838.

1. Enter the Normal / Secure code.
 - Reader status LED flashes green .
2. Press the "#" key to confirm the mode change.
 - Reader status LED turns red .





4.2 Enrolling a Fingerprint

Users must complete a one-time procedure to enroll their fingerprints.

To Enroll Fingerprints in Normal Mode:

1. Present an enrolled proximity card or PIN code.
 - The fingerprint reader LED flashes orange .
2. Place the user's finger on the sensor.
 - The unit sounds a short beep followed by an additional three short beeps.
 - The fingerprint reader LED flashes red .
3. Place the user's finger on the sensor again.
 - The unit sounds a short beep.
 - The fingerprint reader LED turns off.
 - The unit sounds three short beeps to indicate that the fingerprint has been successfully enrolled.
 - If the fingerprint was not successfully enrolled, the unit sounds a single long beep. Repeat the process from the beginning.

To Enroll Fingerprints in Secure Mode:

1. Present an enrolled proximity card.
 - The Reader status LED flashes green .
2. Enter the PIN code of the same user.
 - The Reader status LED turns green .
 - The fingerprint reader LED flashes orange .
3. Place the user's finger on the sensor.
 - The unit sounds a short beep followed by an additional three short beeps.
 - The fingerprint reader LED flashes red .
4. Place the user's finger on the sensor again.
 - The unit sounds a short beep.

- The fingerprint reader LED turns off.
- The unit sounds three short beeps to indicate that the fingerprint has been successfully enrolled.
- If the fingerprint was not successfully enrolled, the unit sounds a single long beep. Repeat the process from the beginning.

4.3 Programming the AYC-W6500

Programming of the AYC-W6500 is performed solely via the unit's keypad, using a built-in Programming Menu System.

To reach the Programming Menu System, first place the AYC-W6500 into Programming Mode. See Entering Programming Mode on page 17 for more information.

During manufacturing, certain codes and settings are pre-programmed into the unit. These settings are referred to here as "Default Factory Settings".

The table below lists all the available AYC-W6500 menus.

Programming Menu

Default Factory Settings are marked by a "*" sign.

Menu Description	Default			
	4 digit	5 digit	6 digit	4-8 digits
1 Selecting PIN Codes Transmission Format				
1. Multiple keys, 26-Bit Wiegand			*	
2. Single Key, 6-Bit Wiegand (Rosslare Format)				
3. Single Key, 6-Bit Wiegand				
4. Single Key, 8-Bit Wiegand				
2 Selecting Card Transmission Format				
1. 26-Bit Wiegand			*	
2. Clock & Data				
3 Changing Programming Code	1234	12341	123412	12341234
4 Setting Secure Mode Code	3838	38383	383838	38383838
5 Changing the Facility Code				
6 General Settings			0004	
Set Lockout			4000	
Keypad Backlight Options			5000	

Reader Functionality

Menu Description	Default			
	4 digit	5 digit	6 digit	4-8 digits
Auxiliary Input (LED_CTL) Toggles Operation Mode			2100	
Auxiliary Input (LED_CTL) Sets LED to Green			2800	
Auxiliary Input (LED_CTL) Controls Buzzer			2900	
Fingerprint Enrollment Enabled(default setting)			7011	
Fingerprint Enrollment Disabled			7012	
7 Enrolling PIN Code				
8 Deleting PIN Code				
0 Return to Factory Default and Set PIN Code Length				
0 - 4 digit PIN code				*
5 - 5 digit PIN code				
6 - 6 digit PIN code				
8 - 4-8 digit PIN code				

Entering Programming Mode

The Programming Mode allows the user to control how the AYC-W6500 behaves and to set operation preferences.



Note:

It is not possible to program the unit while it is operating in Secure mode.

1. Press the "#" key twice.

- The reader status LED flashes orange



2. Enter your programming code.

If the programming code is valid, the Reader status LED turns orange .

The AYC-W6500 is now in Programming Mode.



Note:

The factory default programming code is 1234.
If a programming code is not entered within 60 seconds, the AYC-W6500 will return to Transmit Mode.

Exiting Programming Mode

1. To exit the Programming Mode at any time press the “#” key twice.
 - The unit sounds three short beeps.
 - The Reader status LED turns red █.
 - The AYC-W6500 has now returned to Normal Access Mode.

Selecting the Keypad Transmission Format

The AYC-W6500 can operate using any one of four different keypad transmission formats. The keypad transmission format is set in Menu 1.

Follow the steps below to select the appropriate keypad transmission format that you wish to use.

To Select a Programming Mode:

1. Enter Programming Mode (see Entering Programming Mode, page 17).
2. Press “1”. 1
3. Enter the appropriate option number for the keypad transmission format that you wish to select. ?
 - If an incorrect option number was entered, the reader returns to Normal Access Mode and the keypad transmission format will remain unchanged.
 - See below for more information on the keypad transmission formats.



Note: Only one keypad transmission format can be active at any time.

Keypad Transmission Format Option Number

See the table below to determine the Option Number for the Keypad Transmission Format you wish to select. Keys are transmitted only after the fingerprint is verified and not after each key press.

Keypad Transmission Format	Option Number
Multiple keys, Wiegand 26 bit	0
Single keys, Wiegand 6 bit Rosslare format	1*
Single keys, Wiegand 6 bit	2
Single keys, Wiegand 8 bit	3

* Option 1 is the default factory setting.

More information on each of the different keypad transmission formats is available below and on the following pages.

Reader Functionality

Option 0: Multiple Keys, Wiegand 26 bit



Note:

Option 0 is invalid if the PIN code length has been set to the 4-8 characters option (programming menu 0-8)

The number of keys and frame contents sent with each key press depends on the PIN code length and on the Facility Code settings.

- PIN Code 4 Keys – PIN Code and Facility Code

Bit 1	Even Parity	Bit 10	MSB bit of PIN Hex value
Bit 2-9	Facility Code	Bit 25	LSB bit of PIN Hex value
Bit 10-25	PIN code Hex value	Bit 26	Odd Parity

The PIN number range is 0000 to 9999 (270Fh).

- PIN Code 5 Keys - PIN code and Facility Code

Bit 1	Even Parity	Bit 10	MSB bit of PIN Hex value
Bit 2-9	Facility Code	Bit 25	LSB bit of PIN Hex value
Bit 10-25	PIN code Hex value	Bit 26	Odd Parity

The maximum PIN code is 65535 (0FFFFh). A higher PIN code is not transmitted.

- PIN Code 6 Keys – The PIN code is sent as entered

Bit 1	Even Parity	Bit 14-17	4th digit of PIN
Bit 2-5	1st digit of PIN	Bit 18-21	5th digit of PIN
Bit 6-9	2nd digit of PIN	Bit 22-25	6th digit of PIN
Bit 10-13	3rd digit of PIN	Bit 26	Odd Parity

The PIN number range is 000000 to 999999 (0F423Fh)

- PIN Code 4-8 Keys – Not a valid setting

Option 1: Single Key, 6-Bit Wiegand (Rosslare Format)

Transmission of 4 bits with 2 parity bits added occurs after fingerprint verification, with a delay of 50 ms between each number transmitted.

The first bit is even parity, and set based on bits 2 and 3.

The sixth bit is odd parity, and set based on bits 4 and 5.

0= 1 1010 0 ="A" in Hexadecimal	6= 1 0110 0
1= 0 0001 0	7= 1 0111 1
2= 0 0010 0	8= 1 1000 1
3= 0 0011 1	9= 1 1001 0
4= 1 0100 1	*= 1 1011 1 ="B" in Hexadecimal
5= 1 0101 0	#= 0 1100 1 ="C" in Hexadecimal

- PIN Code 4 Keys - 4 Wiegand 6 bit frames, s entered.
- PIN Code 5 Keys - 5 Wiegand 6 bit frames, 5 digits entered.
- PIN Code 6 Keys - 6 Wiegand 6 bit frames, 6 digits entered.
- PIN Code 4-8 Keys - 4 to 7 Wiegand 6 bit frames, 4-7 keys entered.
Or, 8 Wiegand 6 bit frames, 8 keys entered, followed by # key.

Option 2: Single Key, 6-Bit Wiegand with Parities

Transmission of 4 bits with 2 parity bits added occurs after fingerprint verification, with a delay of 50 ms between each number transmitted.

The first bit is even parity, and set based on bits 2 and 3.

The sixth bit is odd parity, and set based on bits 4 and 5.

0 = 0 0000 1	6 = 1 0110 0
1 = 0 0001 0	7 = 1 0111 1
2 = 0 0010 0	8 = 1 1000 1
3 = 0 0011 1	9 = 1 1001 0
4 = 1 0100 1	* = 1 1010 0 = "A" in Hexadecimal
5 = 1 0101 0	# = 1 1011 1 = "B" in Hexadecimal

"*" and "#" keys are not sent.

- PIN Code 4 Keys - 4 Wiegand 6 bit frames, s entered.
- PIN Code 5 Keys - 5 Wiegand 6 bit frames, 5 digits entered.
- PIN Code 6 Keys - 6 Wiegand 6 bit frames, 6 digits entered.
- PIN Code 4-8 Keys - 4 to 7 Wiegand 6 bit frames, 4-7 keys entered.
Or, 8 Wiegand 6 bit frames, 8 keys entered, followed by # key.

Option 3: Single Key, 8-Bit Wiegand Complemented

Transmission of 4 bits complementing the value of the key pressed sent in Wiegand 8-bit frames occurs after fingerprint verification in several frames 50ms apart, the number of frames depend on the PIN code length.

0 = 1111 0000	6 = 1001 0110
1 = 1110 0001	7 = 1000 0111
2 = 1101 0010	8 = 0111 1000
3 = 1100 0011	9 = 0110 1001
4 = 1011 0100	* = 0101 1010
5 = 1010 0101	# = 0100 1011

"*" and "#" keys are not sent.

- PIN Code 4 Keys - 4 Wiegand 8 bit frames, s entered.

Reader Functionality

- PIN Code 5 Keys - 5 Wiegand 8 bit frames, 5 digits entered.
- PIN Code 6 Keys - 6 Wiegand 8 bit frames, 6 digits entered.
- PIN Code 4-8 Keys - 4 to 7 Wiegand 8 bit frames, 4-7 keys entered.
Or, 8 Wiegand 6 bit frames, 8 keys entered, followed by # key.

Selecting Proximity Card Transmission Format

The AYC-W6500 has two proximity card transmission formats. The card transmission format is set in Menu 2.

Follow the steps below to select the appropriate Proximity Card reader transmission format you wish to use.

To Select a Proximity Card Transmission Format

1. Enter Programming Mode (see Entering Programming Mode, page 17).
2. Press "2" to enter **Menu 2**. 2
3. Enter the appropriate option number for the proximity card transmission format you wish to select. (See below).
If an incorrect option number is entered, the reader will return to Transmit Mode and will remain unchanged.
4. System returns to Normal Access Mode.
 - The unit sounds three beeps.

Proximity Card Transmission Format Option Number:

Option 1: 26-Bit Wiegand

Option 2: Clock & Data

Changing the Programming Code

The programming code is used to enable programming the reader. The programming code is set in menu 3.

To Change the Programming Code:

1. Enter Programming Mode (see Entering Programming Mode, page 17).
2. Press "3" to enter **Menu 3**. 3
3. Enter the new code you wish to set as the programming code. ? ? ? ?
4. System returns to Normal Access Mode.
 - The unit sounds three beeps.



Note:

- The programming code cannot be erased. The code 0000 is not valid and does not delete the programming code.
- The factory default programming code is 1234.
- It is recommended to change the default programming code.

Changing the Secure Code

The Secure Code is used to switch from Normal Mode to Secure Access Mode. The Secure Code is set in Menu 4.

To Change the Secure Code:

1. Enter Programming Mode (see Entering Programming Mode, page 17).
2. Press "4" to enter **Menu 4**.
3. Enter the new code you wish to set as the Secure Code.
4. System returns to Normal Access mode.
 - The unit sounds three beeps.

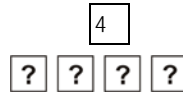

Note:

The default Secure code is 3838.
This code can be erased by entering the PIN code value 0000.

Changing the Facility Code

This code is used only by PIN codes that are transmitted in multiple keys formats. It is inserted in the MSB byte of the transmitted data, one bit following the leading parity bit.

The facility code is set in Menu 5.

To Change the Facility Code:

1. Enter Programming Mode (see Entering Programming Mode, page 17).
2. Press "5" to enter **Menu 5**.
3. Enter the new code number between 0–255 that you wish to set as the Facility Code.
4. System returns to Normal Access mode.
 - The unit sounds three beeps.

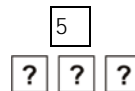

Note:

The default Facility Code is 000.

Reader Functionality

General Unit Settings

General settings and preferences for how the unit operates are set in Menu 6.

Setting the Backlight

The keypad backlight can be set to always on, always off or can be switched on for 10 seconds after a key is pressed. The default is always on.

To Set the Keypad Backlight Mode:

1. Enter Programming Mode (see Entering Programming Mode, page 17).
2. Press "6" to enter **Menu 6**. 6
3. Construct the code using the instructions below: 5 ? ? ?

Digit 1	Digit 2	Digit 3	Digit 4
5	Option: <ul style="list-style-type: none">• 0 : always off• 1 : always on• 2 : lit for 10secs after the first key is pressed	Any number	Any number

**Note:**

In secure mode, option 2 will turn the keypad backlight on whenever a user presents a card.

4. System returns to Normal Access Mode.
 - The unit sounds three beeps.

**Note:**

By default, the backlight is set to Always Off (code 5000)

Setting Lockout

Lockout is intended to stop users from guessing the unit's programming code.

When the programming code is entered incorrectly too many times, the keypad locks and cannot be used for a set period of time. The number of tries and the lockout duration are set in the lockout menu.

To Set the Keypad Lockout Preferences:

1. Enter Programming Mode (see Entering Programming Mode, page 17).
2. Press "6" to enter **Menu 6**.
3. Enter code according to the following:

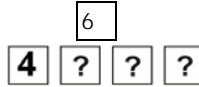

Digit 1	Digit 2	Digit 3	Digit 4
4	<p>1-9 sets the number of consecutive wrong code attempts before a lockout occurs.</p> <p>0 deactivates the Lockout function.</p>	<p>0-99 sets the lockout duration in seconds, divided by a factor of ten.</p> <p>Example: a value of "20" sets the lockout duration at 200secs.</p> <p>When a lockout is triggered, the unit will not function for this period of time.</p>	

4. System returns to Normal Access Mode.
 - The unit sounds three beeps.

Controlling Operation by Auxiliary Input (LED_CTL)

When set, the unit can be toggled between Normal Mode and Secure Mode using the Auxiliary input, "LED_CTL".

Alternatively, it is possible to control the unit's Reader status LED or the buzzer from the LED_CTL input. When the LED_CTL input is set, the LED will turn green or the buzzer will sound.

To Control the Unit via the LED_CTL Auxiliary Input:

1. Enter Programming Mode (see Entering Programming Mode, page 36).
2. Press "6" to enter **Menu 6**.
3. Press "2".
4. Choose one of the following:
 - "1" to toggle the operation mode between Normal and Secure by the LED_CTL Input.
 - "8" to control the reader status LED by the LED_CTL Input.
 - "9" to control the buzzer by the LED_CONTROL Input.

Reader Functionality

5. Press any two keys to complete the code

?	?
---	---

.
6. System returns to Normal Access Mode.
 - The unit sounds three beeps.

Enabling and Disabling Fingerprint Enrollment

By default, when a user presents her proximity card or enters her PIN code for the first time, the AYC-W6500 will automatically request and enroll that user's fingerprint.

For increased security, it is possible to disable automatic fingerprint enrollment.

To Set Fingerprint Enrollment Operation:

1. Enter Programming Mode (see Entering Programming Mode, page 17).
2. Press "6" to enter **Menu 6**.

6

3. Enter "7 0 1".

7	0	1
---	---	---
4. To disable fingerprint enrollment, press "2".
To re-enable fingerprint enrollment, press "1".
5. System returns to Normal Access Mode.
 - The unit sounds three beeps.

Adding and Removing Users from the Reader

The AYC-W6500 maintains an internal database of all the users who may access the unit.

Each user's information is associated with a user slot number. Each user slot number may contain the user's Card code, PIN code and fingerprint details.

There are two ways of finding users within the unit's database:

- **Standard method:** You can manage both Card and PIN codes using the Standard method.

You must already know the user slot number for the user whose details you wish to add.

- **Code Search method:** You can search for users by a current card ID or PIN code using the Code Search method.

Use this method when the user slot code is unknown and you have already assigned the user at least one card or PIN code.







Enrolling Users by Card and PIN Code

Every user may be assigned a proximity card ID, a PIN code ID and one fingerprint record.

Card and PIN code IDs are added in the unit's Programming Mode.





Enroll cards and PIN codes using either the Standard method or the Code Search method.

To Enroll Cards and Codes with the Standard Method:

1. Enter Programming Mode (see Entering Programming Mode, page 17).
2. Press "7" to enter **Menu 7**. 
 - The Reader status LED turns green .
3. Enter a 3-digit User Slot number between 001 and 500 to which you wish to enroll a primary or secondary code. For example, User Slot 003 represents User #3. 
 - If the selected slot has no code, the Reader status LED flashes orange  , indicating that the controller is ready to accept the first ID.
 - If the selected slot already has a Card ID but no PIN code, the Reader status LED flashes red  , indicating that the unit is ready to accept a PIN code.
 - If the selected slot already has a PIN code ID but no Card ID, the Reader status LED flashes green  , indicating that the controller is ready to accept a card ID
 - If the selected slot already has both a Card ID and PIN code, the unit sounds a long beep and the controller returns to the beginning of step 3.
4. Add a new ID (Card or PIN code) for this slot number.
 - If the PIN code is valid, the Reader status LED stops flashing but stays green .
 - The unit waits for another the next 3-digit slot number. A card or PIN code can then be assigned to this new slot.
5. When you are finished enrolling codes, press the "#" key twice. The unit returns to Normal Access Mode.

Reader Functionality





To Enroll Cards and Codes with the Code Search Method:

1. Enter Programming Mode (see Entering Programming Mode, page 17).
2. Press "7" to enter **Menu 7**.
 - The Reader status LED turns green .
3. Enter the 3-digit user slot number 000.
 - The Reader status LED flashes orange .
4. Enter the user ID (Card or PIN Code).
 - If the card presented exists, the Reader status LED flashes red . Continue to the next step.
 - If the PIN Code entered exists, the Reader status LED flashes green . Continue to the next step.
 - If the ID does not exist in the system or if the second ID is already enrolled, the unit sounds a long beep. Repeat step 4 from the beginning.
5. Enter the second ID (Card or PIN code, depending on which was the first ID).
 - If the second ID is valid the Reader status LED flashes orange. To enter more IDs, return to step 4. Press "#" twice to exit Programming Mode.
 - If the second ID is invalid, the unit sounds a long beep. The AYC-W6500 will continue to wait for a valid ID to be entered.
 - If the second ID is of the same type (PIN-PIN/Card-Card), the unit sounds a short beep. The AYC-W6500 will continue to wait for a valid ID to be entered.

Deleting Users

Users can be deleted using the Standard and the Code Search method. Deleting a user erases all IDs of that user— card ID, PIN ID and Fingerprint template.

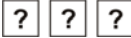
To Delete Codes with the Standard Method:



1. Enter Programming Mode (see Entering Programming Mode, page 17).
2. Press **"8"** to enter **Menu 8**. 
 - The Reader status LED turns red .
3. Enter the 3-digit User Slot code you wish to delete. 
 - If the user slot is empty, the unit sounds a long beep. The AYC-W6500 will continue to wait for a valid user slot number.
 - If the user slot exists, the Reader status LED flashes green  green.
4. Enter your programming code to confirm the deletion. 
 - The unit sounds three short beeps and the AYC-W6500 returns to Normal Access Mode.
 - If the programming code is invalid, the unit sounds a long beep and the AYC-W6500 returns to Normal Access Mode.



Note:

Rosslare recommends that you maintain a written record of added and deleted users. This will make it easier to track and manage which user slots are in use.

To Delete User Codes with the Code Search Method:

1. Enter Programming Mode (see Entering Programming Mode, page 17).
2. Press **"8"** to enter **Menu 8**. 
3. Enter the 3-digit User Slot number 000. 
 - The Reader status LED flashes orange .
4. Present the user's card or enter the user's PIN code
 - If the card or PIN code is not found, the unit sounds a long beep. Present a different card or enter a different PIN code.

Reader Functionality

- If the card or PIN code you entered is found, the Reader status LED flashes green  .

5. Enter your programming code to confirm the deletion.

If the programming code is valid, the unit sounds three beeps and the AYC-W6500 returns to Normal Access Mode.

If the programming code is invalid, the unit sounds a long beep and the AYC-W6500 returns to Normal Access Mode.

PIN Code Length / Factory Default Settings

Use this command to erase all user codes, reset all operation codes to their factory settings and to specify a new PIN code length.

Any user codes, PIN codes or fingerprints that have already been stored in the system will be permanently erased.



Warning:

Use this function with extreme care!
This function erases the unit's memory entirely and resets all codes to their factory default settings.



Note:

Option 8, setting length to 4-8 digits is invalid if Multiple keys, Wiegand 26 bit option of transmission format (1-0) is selected



To Set PIN Code Length and Reset to Factory Default Settings:

1. Enter Programming Mode (see Entering Programming Mode, page 17).
2. Select the desired PIN code length as follows:
 - 00 - Returns to factory defaults and sets a 4 digit code.
 - 05 - Returns to factory defaults and sets a 5 digit code.
 - 06 - Returns to factory defaults and sets a 6 digit code.
 - 08 - Returns to factory defaults and sets a 4-8 digit code.



Note:

When choosing the 4-8 digit option, you can either enter zeros before the code, or press pound at the end (for example if code is **12345**, enter either **00012345** or **12345#**).

- The Reader status LED flashes green  .
3. Enter your programming code. 
 - If the programming code is valid, all memory is

erased. The unit sounds three beeps and the controller returns to Normal Access Mode.

If the programming code is invalid the unit sounds a long beep and the controller returns to Normal Access Mode without erasing the memory of the controller.

**Note:**

The programming code cannot be deleted. For example, 0000 is invalid and will not delete the programming code.

Replacing a Lost Programming Code

In the event that the programming code is forgotten, the unit may be reset after installation.

To Reset the Programming Code

1. Disconnect the unit from its power supply.
2. Activate the tamper sensor by removing the reader from the wall or removing the reader's case.
3. Reconnect the reader to the power supply.
4. You have 10 seconds to enter Programming Mode using the factory default programming code 1234.

5. Controller Functionality

The AYC-W6500 can function both as a reader and as a controller. If the unit is connected to a Rosslare PS-Ax5T/TU or PS-Cx5T/TU intelligent power supply, or others, it functions as a controller. This is indicated by two short beeps on power-on reset.

For increased security and to prevent unauthorized access, the Lock output, Request to Exit input and the auxiliary input and output are not located on the AYC-W6500 unit. Instead, these functions are controlled via the PS-Ax5T/TU or PS-Cx5T/TU intelligent power supply.

The unit's auxiliary LED_CTL input and the auxiliary relay (located on the PS-Ax5T/TU or PS-Cx5T/TU) can be programmed for various auxiliary operations modes to achieve maximum flexibility in various installation conditions.

The following explains how the AYC-W6500 series functions as a controller.

5.1 Introduction

The AYC-W6500 accepts up to 500 users and provides entry via the use of PIN codes and/or Proximity cards after fingerprint verification.

Each user's information is associated with a user slot number. Each user slot number may contain the user's Card code, PIN code and fingerprint details.

The PIN code length can be a set number of 4, 5 or 6 digits or it can be variable length of 4-8 digits.

When choosing the 4-8 digit option, either enter zeros before the code, or press pound at the end (example: for a code 12345, enter either **00012345** or **12345#**).

5.2 Modes of Operation

The AYC-W6500 has two modes of operation:

1. Normal Mode

- Reader Status LED is red 

Normal Mode is the default mode. In Normal Mode the door is locked until a PIN code or card and the user's finger is presented to the controller.

To use the unit in Normal Mode:

- Present the proximity card or enter the PIN code.
- The fingerprint reader LED flashes green 
- Place your finger on the sensor for verification.
- If your fingerprint details are not found in the unit, the fingerprint



reader LED flashes orange 

2. Secure Mode

- Reader status LED flashes red 

In Secure Mode, first present a Proximity card, then enter a PIN code. Next, present a fingerprint for verification to gain entry.

To use the unit in Secure Mode:

- Present your proximity card.
- The Reader status LED flashes green  for ten seconds.
- While the Reader status LED is flashing, enter the PIN code.
- The Reader status LED stops flashing green but stays green 

The fingerprint reader LED flashes green 

- Place your finger on the sensor for verification.
- If your fingerprint details are not found in the unit, the fingerprint

reader LED flashes orange 

Controller Functionality

3. Changing the Modes of Operation

The unit can be easily toggled between Normal and Secure Modes, directly from the keypad.

Changing from Normal Mode to Secure Mode

The default factory setting for the Normal/Secure code is 3838.

1. Enter the Normal / Secure code.

- Reader status LED flashes green



2. Press the "#" to confirm the mode change.

- Reader status LED flashes red



Changing from Secure Mode to Normal Mode

The default factory setting for Normal / Secure code is 3838.

1. Enter the Normal/Secure code.

- Reader status LED flashes green



2. Press the "#" key to confirm the mode change.

- Reader status LED turns red



5.3 Enrolling a Fingerprint

Users must complete a one-time procedure to enroll their fingerprints.

To Enroll Fingerprints in Normal Mode:

1. Present an enrolled proximity card or PIN code.

- The fingerprint reader LED flashes orange



2. Place the user's finger on the sensor.

- The unit sounds a short beep followed by an additional three short beeps.

- The fingerprint reader LED flashes red



3. Place the user's finger on the sensor again.

- The unit sounds a short beep.

- The fingerprint reader LED turns off.

- The unit sounds three short beeps to indicate the fingerprint has been successfully enrolled.
- If the fingerprint is not successfully enrolled, the unit sounds a single long beep. Repeat the process from the beginning.

To Enroll Fingerprints in Secure Mode:

1. Present an enrolled proximity card.

- The Reader status LED flashes green



2. Enter the PIN code of the same user.

- The Reader status LED turns green

- The fingerprint reader LED flashes orange



3. Place the user's finger on the sensor.

- The unit sounds a short beep followed by an additional three short beeps.

- The fingerprint reader LED flashes red



4. Place the user's finger on the sensor again.

- The unit sounds a short beep.
- The fingerprint reader LED turns off.
- The unit sounds three short beeps to indicate that the fingerprint has been successfully enrolled.
- If the fingerprint was not successfully enrolled, the unit sounds a single long beep. Repeat the process from the beginning.

5.4 Door Alarms

Door alarms can be generated by connecting the unit's auxiliary input (LED_CTL) to a Door Position Switch.

Both Door-Forced and Door-Ajar conditions are supported, with a configurable delay timer for each alarm type. Only one Door-alarm is enabled at any one time.

5.5 Case and Back Tamper

If the case of the controller is opened or the controller is removed from the wall, a tamper event is triggered and a coded tamper signal is sent to the secure power supply controller, or other compatible device, which

Controller Functionality

activates the siren. In addition, another output is opened, which can be connected to another device or alarm system, as necessary.

Clear the tamper event by entering a valid Employee or Test Code that will open the Lock Strike Output in the current mode of operation.

For example, while in Secure mode, using the Test Codes to clear a tamper event does not work because the Test Codes do not work in Secure mode. However, applying a Secure Code will clear the tamper event in Secure mode.

5.6 Request to Exit (REX) Function

The REX button is connected to the PS-Cx5T/TU or PS-Ax5T/TU intelligent power supply unit. The REX button is used to open the door without the use of a PIN code and must be located inside the secured premises.

For example, a REX button may be located inside the door or at a receptionist's desk, where authorized personnel can grant entry to visitors.

The function of the REX button depends on whether the Lock output is programmed for Fail Secure Operation or Fail Safe Operation.

- **Fail Secure Operation:** From the moment the REX button is pressed, the door will be unlocked until the Lock output Release Time has passed. After this time, the door will re-lock even if the REX button has not been released.
- **Fail Safe Operation:** From the moment the REX button is pressed, the door will be unlocked. When the REX button is released, the controller waits a for the duration set as the Lock Output Release Time, and then re-locks.

5.7 PS-Ax5T/TU or PS-Cx5T/TU Units

The AYC-W6500 must be used with the PS-Cx5T/TU or PS-Ax5T/TU intelligent power supplies, which provide Lock output and Request to Exit (REX) input.

The supplies include a speaker for bell and siren functionality. The unit signal from the keypad used for the bell is also used for the door-opened chime.

Both units communicate through a proprietary Rosslare protocol, which provides a secure link between the controller and the power supply unit. This in turn activates the door unlocking. For more information see the PS-Cx5T/TU or PS-Ax5T/TU manuals.

5.8 Programming the AYC-W6500

Programming the AYC-W6500 is performed solely via the unit's keypad, using a built-in Programming Menu System.

To reach the Programming Menu System, first place the AYC-W6500 into Programming Mode.

During manufacturing, certain codes and settings are pre-programmed into the unit. These settings are referred to here as "Default Factory Settings".

The table below lists all the available AYC-W6500 menus. It also shows of all the AYC-W6500's default factory codes and settings.

Programming Menu

Menu No.	Menu Description	Default			
		4 digit	5 digit	6 digit	4-8 digits
1	Changing the Test Code	2580	25802	258025	25802580
2	Auxiliary Test (Open Code 2)	0852	08520	085208	08520852
3	Changing Program Code	1234	12341	123412	12341234
4	Changing Normal/Secure Code	3838	38383	383838	38383838
6	Setting Fail Secure / Safe Lock Output, Siren and Lock output Release time			0004	
	Settings Auxiliary Modes and Alarms			2004	
	Set Lockout			4000	
	Keypad Backlight Options			5000	
	Chime Settings			6000	
	Enable Fingerprint Enrollment			7011	
	Disable Fingerprint Enrollment			7012	
7	Enrolling PIN Code				
8	Deleting PIN Code				
9	Open Lock				
	Open Auxiliary				
	Open Lock and Auxiliary				
0	Return to factory defaults / Change PIN code Length			0	

You will find a complete description and instructions for each of the above menu items on the following pages.

Entering Programming Mode

1. Press the "#" key twice.

- The Reader status LED flashes orange



2. Enter your programming code.



Controller Functionality

If the programming code is valid the Reader status LED turns orange .

The AYC-W6500 is now in Programming Mode.



Note:

The factory default programming code is 1234.
If a programming code is not entered within 60 seconds, the AYC-W6500 will return to Transmit Mode.

Exiting Programming Mode

- To exit the Programming Mode at any time press the “#” key twice.
 - The unit sounds three short beeps.
 - The Reader status LED turns red .
 - The AYC-W6500 has now returned to Normal Access Mode.

Changing the Lock Test Code (Testcode1)

The Lock Test Code is an override code that opens the Lock output. It is intended for use during the initial installation of the unit.

When the first user is enrolled into the controller, the default Test Code is automatically deleted. If the code is programmed again, it will not be deleted with the entry of additional user codes.

After the first user is enrolled and the default test code is automatically deleted, the original (default) Test Code can not be re-programmed.

To Change the Lock Test Code (Testcode1):

Enter Programming mode (see Entering Programming Mode, page 36).

- The Reader status LED turns orange .

Press “1” to enter **Menu 1**.



- The Reader status LED turns green .

Enter the new code you wish to set as the Lock Test Code.

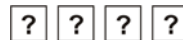

System returns to Normal Access Mode.

- The unit sounds three beeps.



Notes:

- The Lock Test Code does not operate work in Secure Mode.
- Wrong entries return the controller to Normal Mode.
- Code 0000 erases the Test Code.
- The Default Test Code is 2580.

Auxiliary Open Code Settings (Testcode2)

The Auxiliary Open Code activates the auxiliary output. This allows users to test the unit during initial install, or after modifications.

The default auxiliary open code is 0852. Entering an incorrect Auxiliary Open returns the controller to Normal mode.

The Testcode2 Auxiliary Open Code is not deleted by the system. The Auxiliary Open Code does not apply in some auxiliary modes. See "Setting Auxiliary Mode and Alarms", page 40 for more information.





Notes:

Code 0000 erases the Auxiliary Code.

- This code is not active in Secure mode or in certain modes programmed by menu 6-2XXX.

To Set the Auxiliary Open Code:

1. Enter Programming mode (see Entering Programming Mode, page 36).
 - The Reader status LED turns orange .
2. Press "2" to enter **Menu 2**. 2
 - The Reader status LED turns green .
3. Enter the new code you wish to set as the Auxiliary Open Code. ? ? ? ?
System returns to Normal Access Mode.

Changing the Programming Code

The programming code is used to enable programming the controller.

To Change the Programming Code:

4. Enter Programming Mode (see Entering Programming Mode, page 36).
5. Press "3" to enter **Menu 3**.
 - The Reader status LED turns green .
6. Enter the new code you wish to set as programming code. ? ? ? ?
7. System returns to Normal Access Mode.
 - The unit sounds three beeps.

Controller Functionality



Note:

- The programming code cannot be erased. The code 0000 is not valid and will not delete the programming code.
- The factory default programming code is 1234.
- To ensure security, Rosslare recommends changing the default programming code.

Changing the Secure Code

This code allows switching between Normal and Secure Access Mode.

To Change the Secure Code:

1. Enter Programming Mode (see Entering Programming Mode, page 36).
2. Press **"4"** to enter **Menu 4**.
 - The Reader status LED turns green █.
3. Enter the new code you wish to set as Normal / Secure Code.

?

?

?

?
4. System returns to Normal Access Mode.
 - The unit sounds three beeps.



Note:

- Code 0000 will erase the Normal / Secure Code.
- This code is disabled when the Auxiliary Input is set to toggle between Normal and Secure Access modes.
- The default Normal/Secure code is 3838

Setting Fail Safe/Secure Operation, Tamper Siren and Lock Output Release Time

The unit operates in either fail-safe or secure mode.

In either mode, it possible to program how long the siren should sound in the case of a tamper alert, and how long the lock output should remain released.

To Set the Unit to Fail Safe or Secure Mode:

1. Enter Programming Mode (see Entering Programming Mode, page 36).	
2. Press "6" to enter Menu 6 .	<div style="border: 1px solid black; width: 40px; height: 40px; margin: 0 auto;"></div>

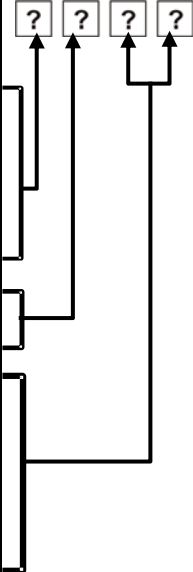
<p>3. Construct the code using the instructions below:</p> <p>First Digit</p> <p>For Fail Secure Operation the first digit should be "0".</p> <p>For Fail Safe Operation the first digit should be "1".</p> <p>Second Digit</p> <p>Siren Time in minutes (1-9, 0-disabled).</p> <p>Third and Fourth Digit</p> <p>Enter the number of seconds (from 1 to 99) that you want the Lock to be released.</p> <p>For example, 0312 means Fail Secure Operation, a 2-minute Siren, and a 12 second Lock output release time.</p>	
<p>4. System returns to Normal Access Mode.</p> <ul style="list-style-type: none"> • The unit sounds three beeps. 	



Note:

The default value is 0004 which corresponds to Fail Secure operation, no siren, and 4-seconds Lock Output release time.

Setting Auxiliary Mode and Alarms

In addition to the Lock output and Lock REX, the AYC-W6500 features an Auxiliary Output and an Auxiliary Input. The Auxiliary Mode defines the function of the Auxiliary Input and Output.

The AYC-W6500 can be set to use these inputs and outputs for a variety of functions.

Setting the Auxiliary Mode

The auxiliary mode must be set on the controller. In addition, the auxiliary input and/or output must be wired as necessary.

To Set Alarms and Auxiliary:

1. Enter Programming mode (see Entering Programming Mode, page 36).

Controller Functionality

- Press "6" to enter **Menu 6**.



- Construct the using the instructions below:

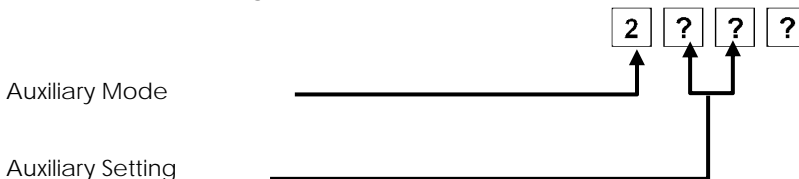

- Each of the Auxiliary Modes has a two digit setting that affects how the Auxiliary Mode functions.

The second digit defines the Auxiliary function.

The third and fourth digits sometimes define delay times for door monitor functions. Otherwise, they have no affect and can be set to any number.

Auxiliary Option Menu

The following quick reference guide indicates the behavior of the auxiliary input and output in each auxiliary mode.

Aux Mode	Auxiliary Input Behavior	Auxiliary Output Trigger	Settings
0	Closes Output	<ul style="list-style-type: none"> Auxiliary input closes Testcode2 entered "Open Aux" user enters card or PIN code 	Duration (secs) output closed (01-99). ("00" toggles output.)
1	Toggles Controller between Normal and Secure modes.	<ul style="list-style-type: none"> Testcode2 entered "Open Aux" user enters card or PIN code 	Duration (secs) output closed (01-99). ("00" toggles output.)

Controller Functionality

2	Toggles Controller between Normal and Secure modes.	<ul style="list-style-type: none"> Star button (*) 	Duration (secs) output closed (01-99). ("00" toggles output.)
3	Toggles Controller between Normal and Secure modes.	<ul style="list-style-type: none"> Tamper event 	Duration (secs) output open (01-99). ("00" sets output to tamper state.)
4	Toggles Controller between Normal and Secure modes.	<ul style="list-style-type: none"> Testcode1 entered "Open Aux" user enters card or PIN code 	Duration (secs) output closed (01-99).
5	Normally, when input is opened, output also opens. After a trigger event, input has no effect for a set duration.	<ul style="list-style-type: none"> Door opened by valid card or PIN code and fingerprint. 	Duration (secs) before output resets to match input (01-99).
6	Opens output after a set duration, if no valid door entry code registered	<ul style="list-style-type: none"> Input opened but no valid door entry code registered. 	Duration (secs) output closed (01-99).
7	If input held open beyond a set duration, the auxiliary output opens	<ul style="list-style-type: none"> Auxiliary input closes 	Duration (secs) output closed (01-99).
8	When input is closed, LED lights green	<ul style="list-style-type: none"> Auxiliary input closes 	Duration (secs) output closed (01-99)
9	When input is closed, LED lights red	<ul style="list-style-type: none"> Auxiliary input closes 	Duration (secs) output closed (01-99)

4. The system returns to Normal Mode.
- The unit sounds three beeps
 - The Reader status LED turns off.

Controller Functionality

Auxiliary Mode Operations

The following is a detailed explanation of the auxiliary input and output behaviors in each of the controller's auxiliary modes.

Auxiliary Mode 0

Auxiliary Input behavior	When the auxiliary input is closed, it triggers the auxiliary output.
Auxiliary Output behavior	When the auxiliary output is triggered, it closes for a set duration. (Auxiliary output is normally open)
Auxiliary Output trigger	The auxiliary output is triggered by one of the following conditions: <ul style="list-style-type: none">• The auxiliary input is closed• A user enters the auxiliary open code (testcode1).• A user with "Open Auxiliary" status presents a valid card or PIN code and fingerprint. (See Open Lock and/or Auxiliary, page 58)
Settings	Time in seconds that the auxiliary output remains closed (01-99). Setting "00" toggles the auxiliary relay.

Example Use:

Operate the controller as a two door controller. The door is opened by a valid code or by the REX control for the second door.

The auxiliary input is connected to a REX button for the second door.

The auxiliary output is connected to the lock on the second door.

Auxiliary Mode 1

Auxiliary Input behavior	When the auxiliary input is closed, the controller switches between Normal and Secure modes.
Auxiliary Output behavior	When the auxiliary output is triggered, it closes for a set duration. (Auxiliary output is normally open)
Auxiliary Output trigger	The auxiliary output is triggered by one of the following conditions: <ul style="list-style-type: none">• A user enters the auxiliary open code (testcode2).• A user with "Open Auxiliary" status presents a valid card or PIN code and fingerprint. (See Open Lock and/or Auxiliary, page 58)
Settings	Time in seconds that the auxiliary output remains closed (01-99). Setting "00" toggles the auxiliary relay.

Example Use:

Using the auxiliary input, allow a time switch or alarm system to automatically switch the controller between normal and secure modes.

The auxiliary input is connected to the alarm system.

Using the auxiliary output, operate the controller as a two door controller. The door is opened by a valid code but there is no REX control for the second door.

The auxiliary output is connected to the lock on the second door.

Controller Functionality

Auxiliary Mode 2

Auxiliary Input behavior	When the auxiliary input is closed, the controller switches between Normal and Secure modes.
Auxiliary Output behavior	When the auxiliary output is triggered, it closes for a set duration. (Auxiliary output is normally open)
Auxiliary Output trigger	The auxiliary output is triggered when the star button (*) is pressed.
Settings	Time in seconds that the auxiliary output remains closed (01-99). Setting "00" toggles the auxiliary relay.

Example Use:

Using the auxiliary input, allow a time switch or alarm system to automatically switch the controller between normal and secure modes.

The auxiliary input is connected to the alarm system.

Using the auxiliary output, open the door using the star button (*).

The auxiliary output is connected to the lock on the door.

(In this mode, the auxiliary open code (testcode2) and "Open Auxiliary" status users do not activate the auxiliary output.)

Auxiliary Mode 3

Auxiliary Input behavior	When the auxiliary input is closed, the controller switches between Normal and Secure modes.
Auxiliary Output behavior	When the auxiliary output is triggered, it opens for a set duration. (Auxiliary output is normally closed)
Auxiliary Output trigger	The auxiliary output is triggered when the controller's tamper sensor is activated.
Settings	Time in seconds that the auxiliary output remains open (01-99). Setting "00" resets the auxiliary output to match the state of the tamper sensor.

Example Use:

Using the auxiliary input, allow a time switch or alarm system to automatically switch the controller between normal and secure modes.

The auxiliary input is connected to the alarm system.

Using the auxiliary output, inform an alarm system or sound a siren when the controller is tampered with.

The auxiliary output is connected to the siren or alarm system.

Controller Functionality

Auxiliary Mode 4

Auxiliary Input behavior	When the auxiliary input is closed, the controller switches between Normal and Secure modes.
Auxiliary Output behavior	When the auxiliary output is triggered, it closes for a set duration. (Auxiliary output is normally open)
Auxiliary Output trigger	The auxiliary output is triggered by one of the following conditions: <ul style="list-style-type: none">• A user enters the auxiliary open code (testcode1).• A user with "Open Auxiliary" status presents a valid card or PIN code and fingerprint. (See Open Lock and/or Auxiliary, page 58)
Settings	Time in seconds that the auxiliary output remains closed (01-99).

Example Use:

Using the auxiliary input, allow a time switch or alarm system to automatically switch the controller between normal and secure modes.

The auxiliary input is connected to the alarm system.

Using the auxiliary output, perform a direct shunt. When a user enters a valid code, the controller overrides the alarm system and unlocks the door.

When the direct shunt duration has completed, the alarm regains control of the door and raises an alarm if the door was left open.

The auxiliary output is connected in parallel with the alarm's door sensor output.

Auxiliary Mode 5

Auxiliary Input behavior	<p>Normally, when the auxiliary input is opened, the auxiliary output also opens. When the input is closed, the output also closes.</p> <p>After a trigger event, the auxiliary input has no effect on the auxiliary output for a set duration.</p>
Auxiliary Output behavior	<p>Normally, when the auxiliary input is opened, the auxiliary output also opens. When the input is closed, the output also closes.</p> <p>When the auxiliary output is triggered, it closes for a set duration and is not affected by the state of the auxiliary input.</p> <p>After this duration, it returns to normal behavior.</p> <p>(Auxiliary output is normally closed)</p>
Auxiliary Output trigger	<p>The auxiliary output is triggered when any user opens the door with a valid card or PIN code and fingerprint.</p>
Settings	<p>Time in seconds before the triggered auxiliary output resets to match the state of the auxiliary input (01-99).</p>

Example Use:

Using the auxiliary input and output, perform a standard shunt. When a user enters a valid code, the controller overrides the alarm system and unlocks the door.

When the standard shunt duration has completed, the alarm regains control of the door and raises an alarm if the door was left open.

The auxiliary input is connected to the door sensor output.

The auxiliary output is connected to the alarm. (The alarm system is not connected directly to the door.)

Controller Functionality

Auxiliary Mode 6

Auxiliary Input behavior	If the auxiliary input is opened and no valid door entry code was entered, the auxiliary output opens after a set duration.
Auxiliary Output behavior	When triggered, the auxiliary output opens after a set duration. (Auxiliary output is normally closed)
Auxiliary Output trigger	The auxiliary output is triggered if no valid door entry code was entered and the auxiliary input is opened.
Settings	Time in seconds before the auxiliary output opens (01-99).

Example Use:

Using the auxiliary input and output, detect if the door has been forced open.

If the door remains open after a set duration but no valid door entry code was entered, then the auxiliary output informs an alarm system or sounds a siren.

The auxiliary input is connected to the door sensor output.

The auxiliary output is connected to the alarm system.

Auxiliary Mode 7

Auxiliary Input behavior	When the auxiliary input is held open for more than a set duration, the auxiliary output opens.
Auxiliary Output behavior	When triggered, the auxiliary output opens after a set duration. (Auxiliary output is normally closed)
Auxiliary Output trigger	The auxiliary output is triggered by the auxiliary input.
Settings:	Time in seconds before the auxiliary output opens (01-99).

Example Use:

Using the auxiliary input and output, detect if the door has been left open for too long.

If the door was opened with a valid code but remains open beyond a set duration, the auxiliary output informs an alarm system or sounds a siren.

The auxiliary input is connected to the door sensor output.

The auxiliary output is connected to the alarm system.

Controller Functionality

Auxiliary Mode 8

Auxiliary Input behavior	When the auxiliary input is closed, the LED lights green.
Auxiliary Output behavior	When the auxiliary output is triggered, it closes for a set duration. (Auxiliary output is normally open)
Auxiliary Output trigger	The auxiliary output is triggered by one of the following conditions: <ul style="list-style-type: none">• A user enters the auxiliary open code (testcode2).• A user with "Open Auxiliary" status presents a valid card or PIN code and fingerprint. (See Open Lock and/or Auxiliary, page 58).
Settings	Time in seconds that the auxiliary output remains closed (01-99). Setting "00" toggles the auxiliary relay.

Example Use:

Using the auxiliary input, control the state of the controller's LED.

Using the auxiliary output, operate the controller as a two door controller. The door is opened by a valid code.

The auxiliary output is connected to the lock on the second door.

Auxiliary Mode 9

Auxiliary Input behavior	When the auxiliary input is closed, the LED lights green.
Auxiliary Output behavior	When the auxiliary output is triggered, it closes for a set duration. (Auxiliary output is normally open)
Auxiliary Output trigger	The auxiliary output is triggered by one of the following conditions: <ul style="list-style-type: none"> • A user enters the auxiliary open code (testcode1). • A user with "Open Auxiliary" status presents a valid card or PIN code and fingerprint. (See Open Lock and/or Auxiliary, page 58).
Settings	Time in seconds that the auxiliary output remains closed (01-99). Setting "00" toggles the auxiliary relay.

Example Use:

When connecting brown wire to GND the buzzer is activated.

Using the auxiliary output, operate the controller as a two door controller. The door is opened by a valid code.

The auxiliary output is connected to the lock on the second door.

Setting Lockout

Lockout is intended to stop users from guessing PIN codes.

When the programming code is entered incorrectly too many times, the keypad locks and cannot be used for a set period of time. The number of tries and the lockout duration are set in the lockout menu.

To Set the Keypad Lockout Preferences:

1. Enter Programming Mode (see Entering Programming Mode, page 36).
2. Press "6" to enter **Menu 6**.
3. Enter code according to the following:

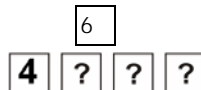

Digit 1	Digit 2	Digit 3	Digit 4

Controller Functionality

4	<p>1-9 sets the number of consecutive wrong code attempts before a lockout occurs.</p> <p>0 deactivates the Lockout function.</p>	<p>0-99 sets the lockout duration in seconds, divided by a factor of ten.</p> <p>Example: a value of "20" sets the lockout duration at 200secs.</p> <p>When a lockout is triggered, the unit will not function for this period of time.</p>
----------	---	--

Setting the Backlight

The keypad backlight can be set to always on, always off or can be switched on for 10 seconds after a key is pressed. The default is always on.

To Set the Keypad Lighting Mode:

1. Enter Programming Mode (see Entering Programming Mode, page 36).

2. Press "**6**" to enter **Menu 6**.

6

3. Construct the code using the instructions below:

5

?

?

?

Digit 1	Digit 2	Digit 3	Digit 4
5	Option: <ul style="list-style-type: none"> • 0 : always off • 1 : always on • 2 : lit for 10secs after a key is pressed 	Any number	Any number



Note:

In secure mode, option 2 will turn the keypad backlight on whenever a user presents a card.

4. System returns to Normal Access Mode.
 - The unit sounds three beeps.

Setting Chime

The chime can be turned on or off.

To Enable or Disable the Chime:

1. Enter Programming Mode (see Entering Programming Mode, page 36).

2. Press **"6"** to enter **Menu 6**.

6

3. Construct the code using the instructions below:

6 ? ? ?

Digit 1	Digit 2	Digit 3	Digit 4
6	Option: <ul style="list-style-type: none"> • 0 : always off • 1 : always on 	Any number	Any number

4. System returns to Normal Access Mode.

- The unit sounds three beeps.

Enabling and Disabling Fingerprint Enrollment

When fingerprint enrollment is enabled, users are required to enroll their fingerprints the first time they present a card or enter an ID code. This is the default setting.

To ensure security, disable fingerprint enrollment after use. This prevents unauthorized persons enrolling their fingerprints using the cards of existing new users.

In addition, disable local fingerprint enrollment when using the unit with the AS-W6500 BioTrax software system. BioTrax will manage fingerprint enrollment from its server computer.

To Set Fingerprint Enrollment:

1. Enter Programming Mode (see Entering Programming Mode, page 36).

2. Press **"6"** to enter **Menu 6**.

6

3. Enter **"7 0 1"** to set fingerprint enrollment.

7 0 1

4. To enable fingerprint enrollment, press **"1"**
To disable fingerprint enrollment, press **"2"**.

5. System returns to Normal Access Mode.

- The unit sounds three beeps.

Controller Functionality

Adding and Removing Users from the Reader

The AYC-W6500 maintains an internal database of all the users who may access the unit.

Each user's information is associated with a user slot number. Each user slot number may contain the user's Card code, PIN code and fingerprint details.

There are two ways of finding users within the unit's database:

- **Standard method:** You can manage both Card and PIN codes using the Standard method.

You must already know the user slot number for the user whose details you wish to add.

- **Code Search method:** You can search for users by a current card ID or PIN code using the Code Search method.

Use this method when the user slot code is unknown and you have already assigned the user at least one card or PIN code.

Enrolling Users by Card and PIN Code

Every user may be assigned a proximity card ID, a PIN code ID and one fingerprint record.

Card and PIN code IDs are added in the unit's Programming Mode.

Enroll cards and PIN codes using either the Standard method or the Code Search method.

To Enroll Cards and Codes with the Standard Method:

To enroll IDs with the Standard Method, you must know user's slot number.

1. Enter Programming Mode (see Entering Programming Mode, page 36).

2. Press "7" to enter **Menu 7**.





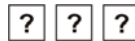

- The Reader status LED turns green .

3. Enter a 3-digit User Slot number between 001 and 500 to which you wish to enroll a primary or secondary code. For example, User Slot 003 represents User #3.







- If the selected slot has no Card ID code, the Reader status LED

flashes orange , indicating that the controller is ready to accept the first ID.

- If the selected slot already has a Card ID but no PIN code, the Reader status LED flashes red , indicating that the controller is ready to accept a PIN code.
 - If the selected slot already has a PIN code ID but no Card ID, the Reader status LED flashes green , indicating that the controller is ready to accept a card ID.
 - If the selected slot already has both a Card ID and PIN code, the unit sounds a long beep and the controller returns to the beginning of step 3.
4. Add a new ID (Card or PIN code) for this slot number.
- If the PIN code is valid, the Reader status LED stops flashing and shines green . The unit waits for another the next 3-digit slot number. A card or PIN code can then be assigned to this new slot.
5. When you are finished enrolling codes, press the “#” key twice. The unit returns to Normal Access Mode.

To Enroll Cards and Codes (Code Search Method):

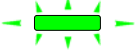
1. Enter Programming Mode (see Entering Programming Mode, page 36). 
2. Press “7” to enter **Menu 7**.
 - The Reader status LED turns green .
3. Enter the 3-digit user slot number 000. 
 - The Reader status LED flashes orange .
4. Enter the user ID (Card or PIN Code).
 - If the card presented exists, the Reader status LED flashes red . Continue to the next step.
 - If the PIN Code entered exists, the Reader status LED flashes green . Continue to the next step.
 - If the ID does not exist in the system or if the second ID is already enrolled, the unit sounds a long beep. Repeat step 4 from the beginning.





Controller Functionality

5. Enter the second ID (Card or PIN code, depending on which was the first ID).
 - If the second ID is valid the Reader status LED flashes orange. To enter more IDs, return to step 4. Press “#” twice to exit programming mode.
 - If the second ID is invalid, the unit sounds a long beep. The AYC-W6500 will continue to wait for a valid ID to be entered.
 - If the second ID is of the same type (PIN-PIN/Card-Card), the unit sounds a short beep. The AYC-W6500 will continue to wait for a valid ID to be entered.

Deleting Users

Users can be deleted using the Standard and the Code Search method. Deleting a user erases all IDs of that user— card ID, PIN ID and Fingerprint template.

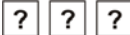
To Delete Codes (Standard Method):

1. Enter Programming Mode (see Entering Programming Mode, page 36). 
2. Press “8” to enter **Menu 8**.
 - The Reader status LED turns red .
3. Enter the 3-digit User Slot codes you wish to delete. 
 - If the User Slot is empty, the unit sounds a long beep. The AYC-W6500 is waiting for a different user slot number.
 - If the user slot exists, the Reader status LED flashes green .
4. Enter your programming code to confirm the deletion. 
 - The unit sounds three short beeps and the AYC-W6500 returns to Normal Access Mode.
 - If the programming code is invalid, the unit sounds a long beep and the AYC-W6500 returns to Normal Access Mode.



Note:

Rosslare recommends that you maintain a written record of added and deleted users. This will make it easier to track and manage which user slots are in use.

To Delete User Codes Using the Code Search Method

1. Enter Programming Mode, (see Entering Programming Mode, page 36).

2. Press **"8"** to enter **Menu 8**.

3. Enter the 3-digit User Slot number 000.

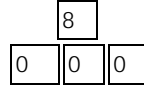

- The Reader status LED flashes



4. Present the user's card or enter the user's PIN code

- If the card or PIN code is not found, the unit sounds a long beep. Present a different card or enter a different PIN code.
- If the card or PIN code you entered is found, the Reader status LED



5. Enter your programming code to confirm the deletion.

If the programming code is valid, the unit sounds three beeps and the AYC-W6500 returns to Normal Access Mode.

If the programming code is invalid, the unit sounds a long beep and the AYC-W6500 returns to Normal Access Mode.

Open Lock and/or Auxiliary

Use this command to program how the controller should behave when a specific user presents a valid card, PIN code or fingerprint.

To Set a User's Open Lock and/or Auxiliary Preferences:

1. Enter Programming Mode (see Entering Programming Mode, page 36).

2. Press **"9"** to enter **Menu 9**.

3. Enter a 3-digit User Slot number between 001 and 500. For example, User Slot 003 represents User #3.

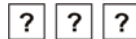

4. Select the action to be performed when this user presents her card, PIN code or fingerprint:

- **"1"** Open Lock
- **"2"** Open Auxiliary
- **"3"** Open Lock and Auxiliary

Controller Functionality

5. The unit sounds three short beeps and the AYC-W6500 returns to Normal Access Mode.

PIN Code Length / Factory Default Settings

Use this command to reset all codes to their factory settings and to specify a new PIN code length.



Warning:

Use this function with extreme care!
This function erases the unit's memory entirely and resets all codes to their factory default settings.

To Set PIN Code Length and Reset to Factory Default Settings:

1. Enter Programming Mode (see Entering Programming Mode, page 36).
2. Select the desired PIN code length as follows:
 - 00 - Returns to factory defaults and sets a code.
 - 05 - Returns to factory defaults and sets a 5 digit code.
 - 06 - Returns to factory defaults and sets a 6 digit code.
 - 08 - Returns to factory defaults and sets a 4-8 digit code.



Note:

When choosing the 4-8 digit option, you can either enter zeros before the code, or press pound at the end (for example if code is **12345**, enter either **00012345** or **12345#**).

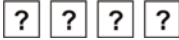
- The Reader status LED flashes green .
3. Enter your programming code.
 - If the programming code is valid, all memory is  erased. The unit sounds three beeps and the controller returns to Normal Access Mode.

If the programming code is invalid you will hear a long beep and the controller returns to Normal Access Mode without erasing the memory of the controller.



Note:

The programming code cannot be deleted. For example, 0000 is invalid and will not delete the programming code.

Replacing a Lost Programming Code

In the event that the programming code is forgotten, the unit may be reset after installation.



Note:

The AYC-W6500 must be in Normal mode. Make sure that the Reader status LED is red before proceeding.

To Reset the Programming Code

1. Disconnect the Power Supply Unit (PS-A25T Power Supply or PS-C25T).
2. Press the REX Button on the Power Supply Unit (PS-A25T Power Supply or PS-C25T).
3. Reconnect the power supply to the unit with REX button pressed.
4. Release the REX Button.
5. You now have 15 seconds to program a new Programming code into the Unit using the initial default code **1234**, before the controller reverts to the existing code.

Replacing a Lost Normal / Secure Code

In the event that the Normal / Secure code is forgotten, the unit may be reset after installation.



Note:

The AYC-W6500 must be in Secure Mode. Make sure that the Reader status LED flashes red before proceeding.

To Reset the Normal / Secure Code

1. Disconnect the Power Supply Unit (PS-A25T Power Supply or PS-C25T).
2. Press the REX Button on the Power Supply Unit (PS-A25T Power Supply or PS-C25T).
3. Reconnect the power supply to the unit with the REX button pressed.
4. Release the REX Button.
5. You now have 15 seconds to enter the default Normal / Secure code (3838) into the Unit.
Enter a new Normal / Secure code using the standard procedure.

Limited Warranty

Appendix A. Limited Warranty

ROSSLARE ENTERPRISES LIMITED S (Rosslare) TWO YEARS LIMITED WARRANTY is applicable worldwide. This warranty supersedes any other warranty. Rosslare's TWO YEARS LIMITED WARRANTY is subject to the following conditions:

Warranty

Warranty of Rosslare's products extends to the original purchaser (Customer) of the Rosslare product and is not transferable.

Products Covered By This Warranty and Duration

ROSSLARE ENTERPRISES LTD. AND / OR SUBSIDIARIES (ROSSLARE) warrants that the AYC-W6500 biometric convertible PIN & Prox reader and controller with fingerprint verification, to be free from defects in materials and assembly in the course of normal use and service. The warranty period commences with the date of shipment to the original purchaser and extends for a period of 2 years (24 Months).

Warranty Remedy Coverage

In the event of a breach of warranty, ROSSLARE will credit Customer with the price of the Product paid by Customer, provided that the warranty claim is delivered to ROSSLARE by the Customer during the warranty period in accordance with the terms of this warranty. Unless otherwise requested by ROSSLARE ENTERPRISES LTD. AND / OR SUBSIDIARIES representative, return of the failed product(s) is not immediately required.

If ROSSLARE has not contacted the Customer within a sixty (60) day holding period following the delivery of the warranty claim, Customer will not be required to return the failed product(s). All returned Product(s), as may be requested at ROSSLARE ENTERPRISES LTD. AND /OR SUBSIDIARY'S sole discretion, shall become the property of ROSSLARE ENTERPRISES LTD. AND /OR SUBSIDIARIES.

To exercise the warranty, the user must contact Rosslare Enterprises Ltd. to obtain an RMA number after which, the product must be returned to the Manufacturer freight prepaid and insured

In the event ROSSLARE chooses to perform a product evaluation within the sixty (60) day holding period and no defect is found, a minimum US\$ 50.00 or equivalent charge will be applied to each Product for labor required in the evaluation.

Rosslare will repair or replace, at its discretion, any product that under normal conditions of use and service proves to be defective in material or workmanship. No charge will be applied for labor or parts with respect to defects covered by this warranty, provided that the work is done by Rosslare or a Rosslare authorized service center.

Exclusions and Limitations

ROSSLARE shall not be responsible or liable for any damage or loss resulting from the operation or performance of any Product or any systems in which a Product is incorporated. This warranty shall not extend to any ancillary equipment not furnished by ROSSLARE, which is attached to or used in conjunction with a Product, nor to any Product that is used with any ancillary equipment, which is not furnished by ROSSLARE.

This warranty does not cover expenses incurred in the transportation, freight cost to the repair center, removal or reinstallation of the product, whether or not proven defective.

Specifically excluded from this warranty are any failures resulting from Customer's improper testing, operation, installation, or damage resulting from use of the Product in other than its normal and customary manner, or any maintenance, modification, alteration, or adjustment or any type of abuse, neglect, accident, misuse, improper operation, normal wear, defects or damage due to lightning or other electrical discharge. This warranty does not cover repair or replacement where normal use has exhausted the life of a part or instrument, or any modification or abuse of, or tampering with, the Product if Product disassembled or repaired in such a manner as to adversely affect performance or prevent adequate inspection and testing to verify any warranty claim.

ROSSLARE does not warrant the installation, maintenance, or service of the Product. Service life of the product is dependent upon the care it receives and the conditions under which it has to operate.

In no event shall Rosslare be liable for incidental or consequential damages.

Limited Warranty Terms

THIS WARRANTY SETS FORTH THE FULL EXTENT OF ROSSLARE ENTERPRISES LTD. AND IT'S SUBSIDIARY'S WARRANTY

THE TERMS OF THIS WARRANTY MAY NOT BE VARIED BY ANY PERSON, WHETHER OR NOT PURPORTING TO REPRESENT OR ACT ON BEHALF OF ROSSLARE.

THIS LIMITED WARRANTY IS PROVIDED IN LIEU OF ALL OTHER WARRANTIES. ALL OTHER WARRANTIES EXPRESSED OR IMPLIED, INCLUDING WITHOUT LIMITATION, IMPLIED WARRANTIES OF MERCHANTABILITY AND FITNESS FOR A PARTICULAR PURPOSE, ARE SPECIFICALLY EXCLUDED.

IN NO EVENT SHALL ROSSLARE BE LIABLE FOR DAMAGES IN EXCESS OF THE PURCHASE PRICE OF THE PRODUCT, OR FOR ANY OTHER INCIDENTAL, CONSEQUENTIAL OR SPECIAL DAMAGES, INCLUDING BUT NOT LIMITED TO LOSS OF USE, LOSS OF TIME, COMMERCIAL LOSS, INCONVENIENCE, AND LOSS OF PROFITS, ARISING OUT OF THE INSTALLATION, USE, OR INABILITY TO USE SUCH PRODUCT, TO THE FULLEST EXTENT THAT ANY SUCH LOSS OR DAMAGE MAY BE DISCLAIMED BY LAW.

THIS WARRANTY SHALL BECOME NULL AND VOID IN THE EVENT OF A VIOLATION OF THE PROVISIONS OF THIS LIMITED WARRANTY.

Appendix B. Technical Support

Asia Pacific, Middle East, Africa

Rosslare Security Products Headquarters
905-912 Wing Fat Industrial Bldg,
12 Wang Tai Road,
Kowloon Bay Hong Kong
Tel: +852 2795-5630
Fax: +852 2795-1508
E-mail: support.apac@rosslaresecurity.com

United States and Canada

1600 Hart Court, Suite 103
Southlake, TX, USA 76092
Toll Free: +1-866-632-1101
Local: +1-817-305-0006
Fax: +1-817-305-0069
E-mail: support.na@rosslaresecurity.com

Europe

Global Technical Support & Training Center
HaMelecha 22
Rosh HaAyin, Israel 48091
Tel: +972 3 938-6838
Fax: +972 3 938-6830
E-mail: support.eu@rosslaresecurity.com

South America

Pringles 868, 1640 Martinez
Buenos Aires
Argentina
Tel: +54 11 4798-0095
Fax: +54 11 4798-2228
E-mail: support.la@rosslaresecurity.com

Web Site: www.rosslaresecurity.com

ROSSLARE
SECURITY PRODUCTS

www.rosslaresecurity.com

0706-0960098+03

CE

