

SONOFF

ZBMINI Extreme

User manual V1.0

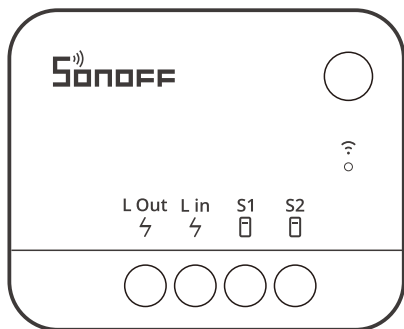

Zigbee Smart Switch

(No Neutral Required)

产品介绍

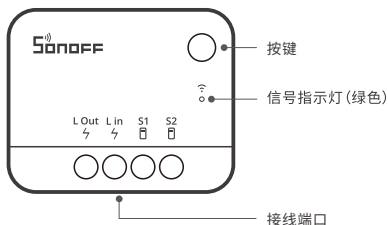

⚠ 设备重量 < 1Kg, 建议安装高度 < 2米。

指示灯状态说明

指示灯状态	状态说明
绿灯慢闪	配对模式
绿灯常亮 (继电器处于打开状态时)	网络连接正常
绿灯快闪 (继电器处于打开状态时)	网络连接异常 ZBMINI Extreme与父设备连接正常, 路由器与网关断连
绿灯慢闪	网络连接异常 非配网状态下慢闪: ZBMINI Extreme与父设备断连

功能特点

SONOFF 单通道单火开关改装件, 作为 Zigbee 子设备, 可通过连接 Zigbee 网关实现远程控制、设置定时开/关、设备智能场景联动等功能。



远程控制



智能定时/延时



语音控制



OTA升级



智能场景



外接开关



上电状态



添加摄像头

⚠ 以上功能特点取决于 Zigbee 网关的功能。

设备安装

1. 断电

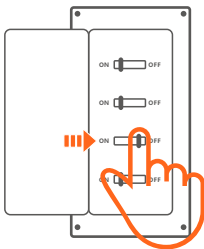

⚠ 设备安装、故障维修请由专业资质电工操作。切勿在设备通电时进行接线操作或触碰到接线端子，以免发生触电危险！

2. 接线

安装设备前，需给设备安装空气开关保护装置（空气开关: 10A/250V）

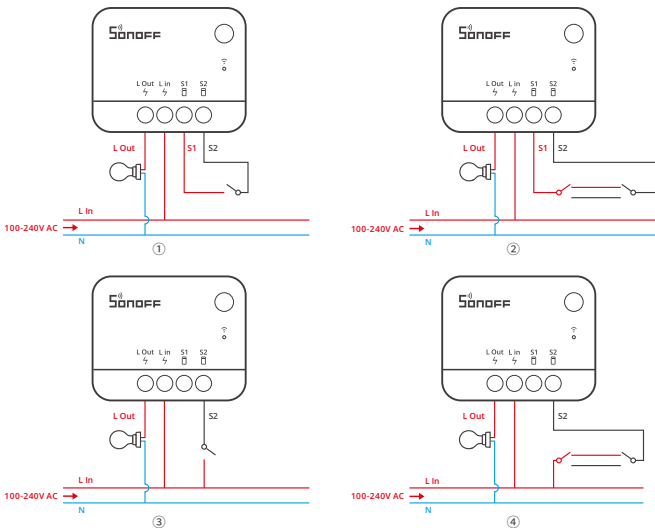

Ⓢ 以上③④接线方式请确保设备 L in 端供电输入正常，否则会导致设备工作异常。

- ⓘ 外接的开关类型支持翘板和自回弹开关，出厂默认为支持翘板开关类型。
- ⓘ 本设备不支持其它类型的感性负载如风扇等。
- ⓘ 确保线路接入无误。

配对至易微联App

1. 下载“易微联”App



2. 添加SONOFF Zigbee网关

3. 上电

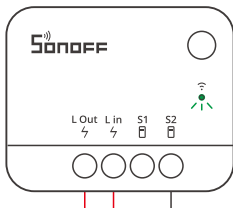

通电后，设备首次使用，默认进入配对模式，绿色指示灯呈“慢闪”状态。

- ⓘ 三分钟内没下一步操作，设备将退出配对模式，如需再次进入，长按设备按键5秒直到绿色指示灯呈“慢闪”状态即可。
- ⓘ 当设备处于配网状态时，设备保持关闭状态，不受设备按键或外接开关的控制。

4. 将 ZBMINI Extreme 添加至网关

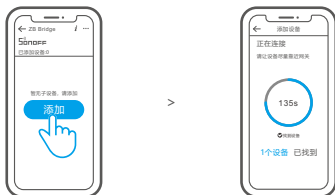

打开eWeLink App, 在网关界面, 点击 "添加" 子设备, 等待搜索添加子设备。

配对至亚马逊音箱

1. 下载最新版Amazon Alexa App, 并配对带Zigbee网关的亚马逊音箱。
2. 给 ZBMINI Extreme 上电, 设备默认进入配对模式, 绿色信号指示灯呈“慢闪”状态。

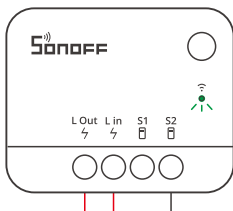

ⓘ 当设备处于配网状态时, 设备保持关闭状态, 不受设备按键或外接开关的控制

3. 对亚马逊音箱说 "Alexa, discover my devices", 即可自动发现设备。

ⓘ 三分钟内没配对成功, 设备将退出配对模式, 长按设备按键5S使其再次进入配对模式。

将开关切换到对应的类型

出厂默认为支持翘板开关类型，如需切换开关类型，短按按键三次且绿灯快闪3下，此时开关类型切换成功。

⚠ 请在设备放进暗盒前切换到对应的开关类型。

将ZBMINI Extreme安装在暗盒中

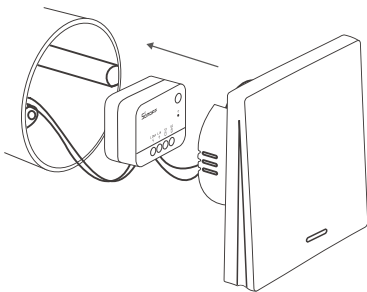

产品参数

产品型号	ZBMINI2
输入	100-240V AC 50/60Hz 6A Max
输出	100-240V AC 50/60Hz 6A Max
最大负载	☀ 阻性负载: 6A Max LED: 150W Max @100V, 300W Max @240V
无线连接	Zigbee 3.0
工作温度	-10~40°C
外壳材料	PC V0
产品规格	39.5x32x18.4mm

恢复出厂设置

可通过以下任意方法让设备恢复出厂设置(恢复出厂设置后设备自动进入配对模式):

1. 连接外接开关10下。
2. 长按设备按键5秒。
3. 在 eWeLink App 端删除子设备。

支持的语音平台



Product introduction

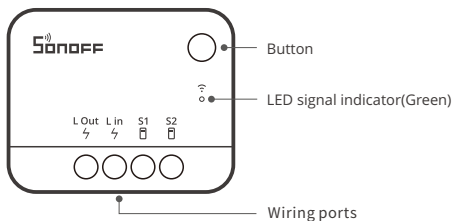

ⓘ The device weight is less than 1kg, and the recommended installation height is less than 2m.

LED indicator status instruction

LED indicator status	Status instruction
Green LED indicator slow flashes	Pairing mode
Green LED indicator keeps on (Relay is powered on)	Device is on line
Green LED indicator quick flashes (Relay is powered on)	Abnormal network connection ZBMINI Extreme and router connect normally, but router and the hub are disconnected
Green LED indicator slow flashes (Relay is powered on)	Abnormal network connection Slow flashing under non-pairing state: ZBMINI Extreme and the parent device are disconnected

Features

SONOFF Zigbee smart switch (No neutral required) allows you to remote control, schedule on/off and set smart scenes to trigger other devices, etc. by connecting Zigbee hub.



Remote Control



Single/Countdown
Timing



Voice Control



OTA Upgrade



Smart Scene



External Switch



Power on State



Camera Linking

ⓘ Above functions are determined by the connected Zigbee Hub.

Installation

1. Power off

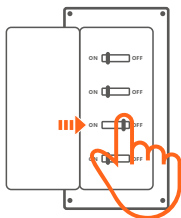

⚠ Please install and maintain the device by a professional electrician. To avoid electric shock hazard, do not operate any connection or contact the terminal connector while the device is powered on!

2. Wiring instruction

Before installing the device, please install an air switch as the protective device (Air switch: 10A/250V).

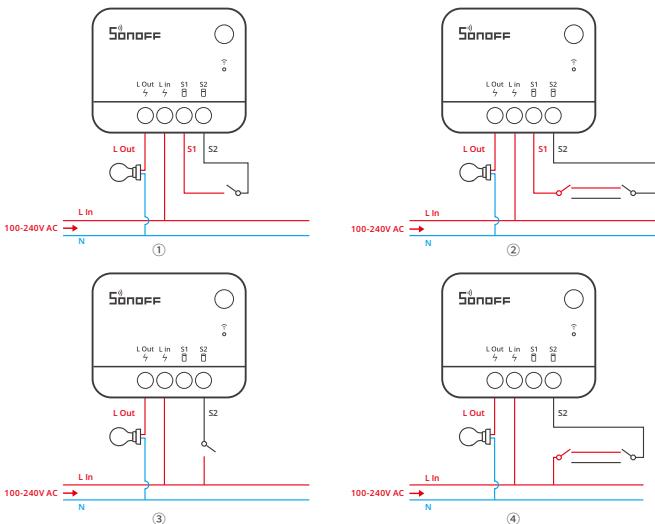

⚠ For the above ③④ wiring methods, please ensure the proper wiring and powering of the L in terminal, otherwise it will cause the device to work abnormally.

- ⓘ Supported switches are rocker switch and push button and factory default by supporting rocker switch.
- ⓘ Unsupported to use with other Inductive loads such as fan.
- ⓘ Make sure all wires are connected correctly.

Pair with eWeLink App

1. Download the eWeLink App



2. Pair SONOFF Zigbee Bridge to your eWeLink account

3. Power on

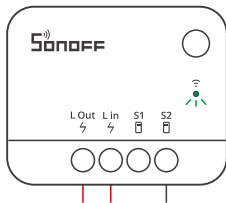

After powering on, the device will enter the pairing mode defaulted during the first use and the green LED indicator will "flash slowly".

- ⓘ The device will exit the pairing mode if you do not operate it within 3mins. If you want to enter the pairing mode again, press and hold the button of the device for 5 seconds until the green Led indicator "flashes slowly" and releases.
- ⓘ The device will remain off and cannot be controlled by the device's button or external switch when it is in pairing mode.

4. Add ZBMINI Extreme to the ZB Bridge

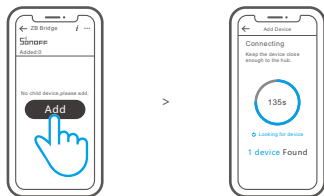

Open eWeLink App, tap "Add" icon on the ZB Bridge interface, then wait to looking for and add the sub-devices.

Pair with Amazon Echo

1. Download the latest Amazon Alexa App and pair it with Amazon Echo with built-in Zigbee hub.
2. Power on ZBMINI Extreme, then it defaulted to enter the pairing mode and the green LED indicator "flashes slowly".

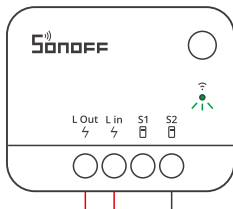

⚠ The device will remain off and cannot be controlled by the device's button or external switch when it is in pairing mode.

3. Ask the Alexa Echo to discover the devices automatically by saying "Alexa, discover my devices".

⚠ If failed to pair within 3mins, ZBMINI Extreme will exit the pairing mode. Long press the button on ZBMINI Extreme for 5s to make it enter the pairing mode if you need to pair again.

Switch the device to the corresponding switch

The device supports rocker switch by default. If you want to change the switch type, press the button 3 times and see the green Led indicator flash 3 times quickly, then the switch type is switched successfully.

⚠ Please switch to the corresponding switch type before installing the device in the mounting box.

Install the ZBMINI Extrene in the mounting box

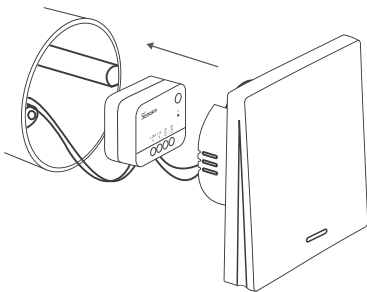

Specifications

Model	ZBMINIL2
Input	100-240V AC 50/60Hz 6A Max
Output	100-240V AC 50/60Hz 6A Max
Max. load	 Resistive load: 6A Max LED: 150W Max @100V, 300W Max @240V
Wireless connection	Zigbee 3.0
Working temperature	-10~40°C
Casing material	PC V0
Product Size	39.5x32x18.4mm

Factory reset

Return the device to its factory settings in any following ways (Device will enter the pairing mode automatically after resetting)

1. Press 10 consecutive times the connected external switch
2. Long-press the device for 5s.
3. Delete the sub-device on eWeLink App

Supported voice assistant



FCC Warning

Changes or modifications not expressly approved by the party responsible for compliance could avoid the user's authority to operate the equipment.

This device complies with part 15 of the FCC Rules. Operation is subject to the following two conditions: (1) This device may not cause harmful interference, and (2) this device must accept any interference received, including interference that may cause undesired operation.

FCC Radiation Exposure Statement:

This equipment complies with FCC radiation exposure limits set forth for an uncontrolled environment. This equipment should be installed and operated with minimum distance 20cm between the radiator & your body. This transmitter must not be co-located or operating in conjunction with any other antenna or transmitter.

Note:

This equipment has been tested and found to comply with the limits for a Class B digital device, pursuant to part 15 of the FCC Rules. These limits are designed to provide reasonable protection against harmful interference in a residential installation. This equipment generates, uses and can radiate radio frequency energy and, if not installed and used in accordance with the instructions, may cause harmful interference to radio communications. However, there is no guarantee that interference will not occur in a particular installation. If this equipment does cause harmful interference to radio or television reception, which can be determined by turning the equipment off and on, the user is encouraged to try to correct the interference by one or more of the following measures:

- Reorient or relocate the receiving antenna.
- Increase the separation between the equipment and receiver.
- Connect the equipment into an outlet on a circuit different from that to which the receiver is connected.
- Consult the dealer or an experienced radio/TV technician for help.

IC Warning

This device complies with Innovation, Science and Economic Development Canada licence-exempt RSS standard (s). Operation is subject to the following two conditions: (1) this device may not cause interference, and (2) this device must accept any interference, including interference that may cause undesired operation of the device.

Le onjunc areil est conforme aux CNR d' l'innovation, la science et le développement économique Canada licables aux areils radio exempts de licence.

L'exploitation est autorisée aux deux conditions suivantes:

- l'areil ne doit pas produire de brouillage, et;
- l'utilisateur de l'appareil doit accepter tout brouillage radioélectrique subi, onj si le brouillage est susceptible d'en compromettre le fonctionnement.

Any changes or modifications not expressly approved by the party responsible for compliance could void the user's authority to operate the equipment.

Tous les changements ou modifications non expressément approuvée par le responsable de la conformité pourrait vider l'utilisateur est habilité à exploiter l'équipemen.

ISED Radiation Exposure Statement:

This equipment complies with ISED RF radiation exposure limits set forth for an uncontrolled environment.

This transmitter must not be co-located or operating in conjunction with any other antenna or transmitter.

Cet appareil est

conforme aux limites d'exposition de rayonnement RF ISED établies pour un environnement non contrôlé.

Cet émetteur ne doit pas être co-implanté ou fonctionner en onjunction avec toute autre antenne ou transmetteur.

Herby, Shenzhen Sonoff Technologies Co., Ltd. declares that the radio equipment type ZBMINIL2 is in compliance with Directive 2014/53/EU. The full text of the EU declaration of conformity is available at the following internet address:

<https://sonoff.tech/usermanuals>

Operation frequency Range: 2405-2480MHz(Zigbee)

RF Output Power: 4.81dBm(Zigbee)

SONOFF

Shenzhen Sonoff Technologies Co., Ltd.

3F & 6F, Bldg A, No. 663, Bulong Rd, Shenzhen, Guangdong, China

ZIP code: 518000

Website: sonoff.tech

MADE IN CHINA

