

Installation Manual

Heating Unit HU-3

Thank you for choosing the Optex Heating Unit HU-3. Please read this Installation Manual before using the product. It contains important maintenance and management information and should be stored by the individual responsible for managing the system.

Installing the HU-3 Heating Unit

Use the HU-3 with a supply voltage of 24 VAC/DC.

Note When using the same power supply as the sensor, position the HU-3 so that it is not farther from the power supply than the wire wiring distance noted in 3-4 below.

1 Cutout of the knockouts

Knockouts are provided on the back of the transmitter/receiver to accommodate the power cables for the heater.

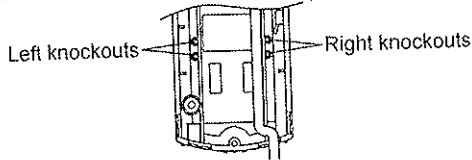

[Rear view of the unit base]

- Cut out either the left or the right knockouts with a nipper or other tool to reveal the wiring holes.
- Cut out the shaded area.

[Knockout cutoff section]

2 Direction of the optical unit

Rotate the optical unit approximately 45° away from the knockout area that you cut out in Step 1.

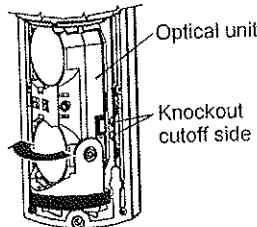

[Front view of the unit base]

3 Mounting and wiring of the heating unit

1. Align the heater as shown in the diagram and slide it into place behind the product's optical unit.

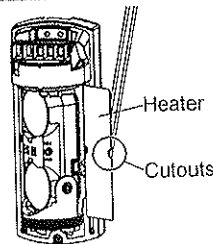

2. Route the heater cables through the heater cutouts and pass them through the wiring holes you cut in Step 1.

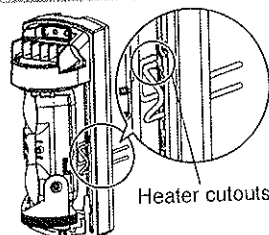

3. Pull the heater cables through the wiring holes until there is no slack remaining.

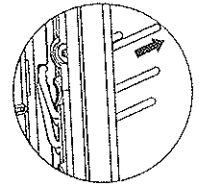

4. Seal the wiring holes with the waterproof material (included) so that there is no gap between the wire and the surrounding plastic. Repeat it for both holes.

Waterproof material (included)

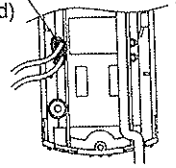

Note Ensure that the wiring distance from the power supply is within the range shown in the table on the right. When using 2 or more units on 1 wire, the maximum wiring distance is obtained by dividing the wire distance listed below by the number of units used.

Wiring distance from power supply	
Wire size	Power supply: 24 VAC/DC
AWG18 (0.83 mm ²)	1000 ft. (300 m)
AWG16 (1.31 mm ²)	1700 ft. (500 m)
AWG14 (2.09 mm ²)	2600 ft. (800 m)

4 Connection using the connector

When connecting the lead wires to the wiring, make the connection using the included connector or soldering. Insert the wires into the connector and tighten the connections with pliers.

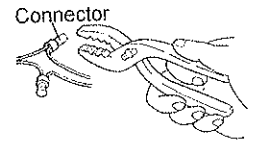

Specifications

Name	Heating Unit
Model	HU-3
Power supply	24 VAC/DC
Current consumption	210 mA (max.) (per heater)
Max. surface temperature	Approx. 140 °F (60 °C)
Operating temperature	-31 °F to +140 °F (-35 °C to +60 °C)
Weight	Approx. 0.2 oz (6 g) (per heater)
Package contents	Heaters x 2, Connectors x 4 Waterproof material

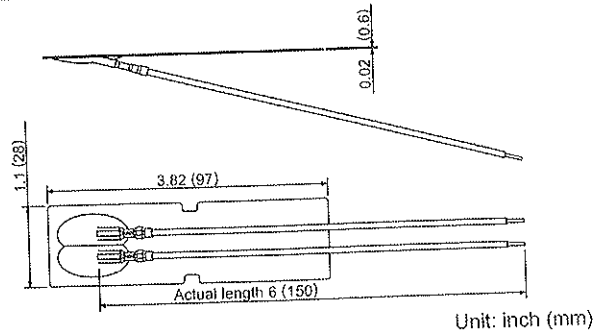

Unit: inch (mm)