

Installation Guide

JetStream Gigabit Smart PoE+ Switch

LED Explanation

Power

On: Power on
Off: Power off

System

Flashing: System running normally
On/Off: System running abnormally

Link/Act (port 1–8)

On (Green): Running at 1000 Mbps
On (Yellow): Running at 10/100 Mbps
Flashing: Transmitting/receiving data
Off: No connected device

SFP1/SFP2 (for TL-SG2210P)

On (Green): Running at 1000 Mbps
On (Yellow): Running at 100 Mbps
Flashing: Transmitting/receiving data
Off: No connected device

PoE Status

For Port 1–4 of TL-SG2008P/Port 1–8 of TL-SG2210P
On: Providing PoE power
Flashing: Current-overload/Short-circuit/Connected to a non-standard PD/Power exceeded the user-defined value
Off: Not providing PoE Power

PoE MAX

For TL-SG2008P
On: $55\text{ W} \leq \text{Total power supply} < 62\text{ W}$
Flashing: Total power supply keeps $\geq 55\text{ W}$ more than 2 minutes
Off: Total power supply $< 55\text{ W}$

For TL-SG2210P
On: $54\text{ W} \leq \text{Total power supply} < 61\text{ W}$
Flashing: Total power supply keeps $\geq 54\text{ W}$ more than 2 minutes
Off: Total power supply $< 54\text{ W}$

For simplicity, we will take TL-SG2210P for example throughout the Guide.

Connection

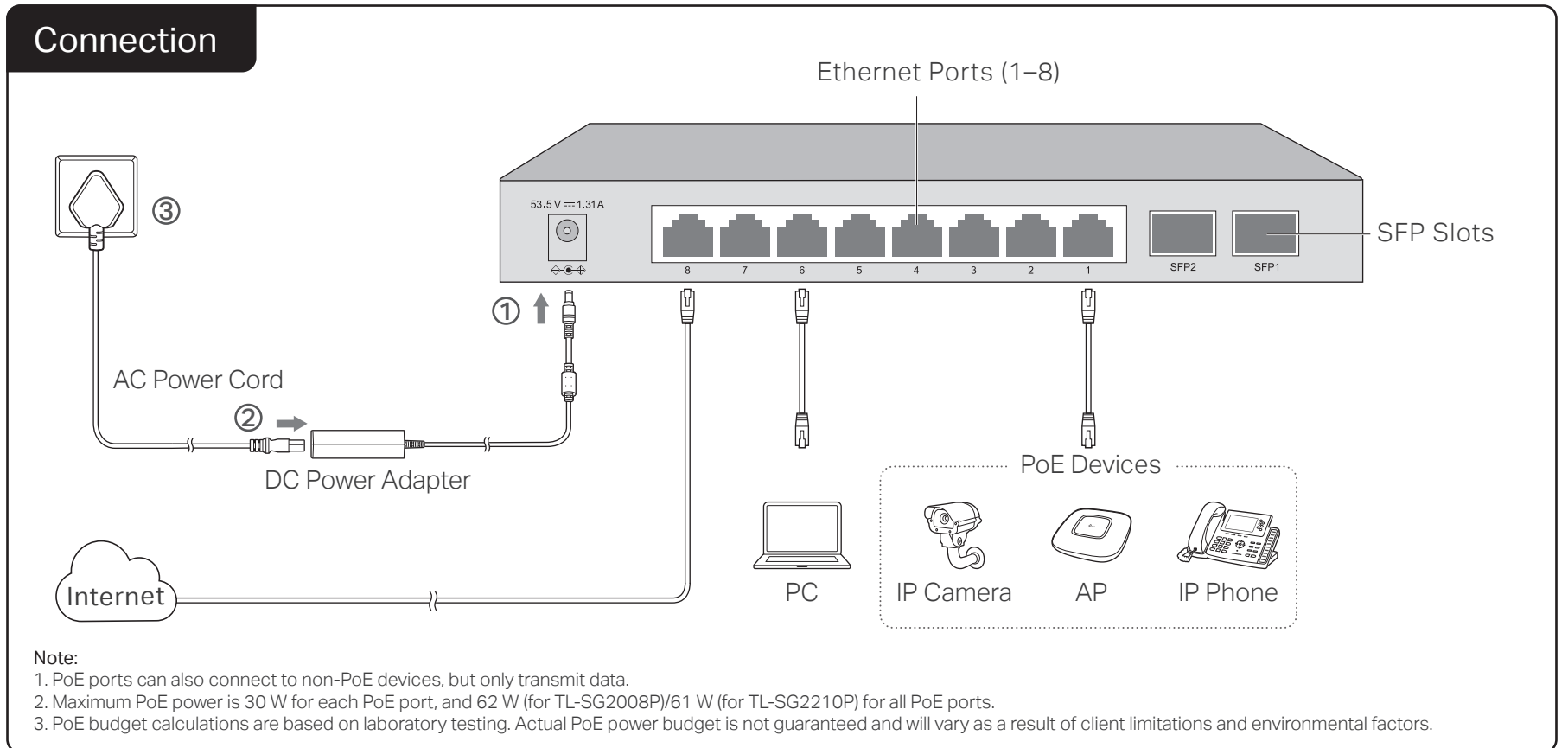

Configuration

The switch supports two configuration methods:

- Standalone Mode: Configure and manage the switch singly.
- Controller Mode: Configure and manage the network devices centrally. It is recommended in the large-scale network, which consists of mass devices such as access points, switches, and gateways.

Note: When the switch is changed from Standalone Mode to Controller Mode, configurations of the switch will be lost. For details, refer to the related documents on the download center of our official website: <https://www.tp-link.com/support/download/>.

Method 1: Standalone Mode

In Standalone Mode, use a computer to configure and manage the switch.

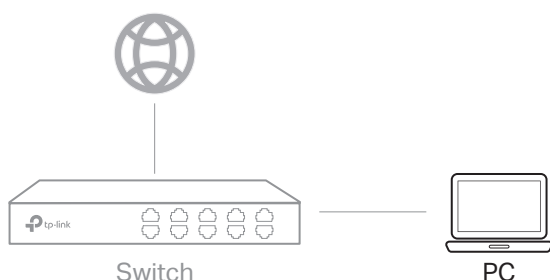

- To access the management page of the switch, open a browser and type the switch's IP address in the address field, then press the **Enter** key.
 - If the switch obtains IP address from the DHCP server (typically a router), find the switch's IP address on the DHCP server.
 - If not, use the default IP address **192.168.0.1** to launch the switch's management page.

Note: Make sure the switch and computer are in the same subnet.

- Enter **admin** for both the username and password in the lower case letters to log in. The first time you log in, change the password to better protect your network and devices.
- After a successful login, the main page will appear. You can click the menus on the top side and left side to configure the corresponding functions.

For the detailed configurations, refer to the User Guide and CLI Guide. The guides can be found on the download center of our official website: <https://www.tp-link.com/support/download/>.

Method 2: Controller Mode

Choose from the following two types of Omada Controller:

• Type 1: Omada Hardware Controller (OC200/OC300)

Omada Hardware Controller (OC200/OC300) is a good alternative if you have no spare PC to keep running Omada Software Controller in the network. It needs to be purchased additionally. For more details, refer to the Installation Guide of OC200/OC300.

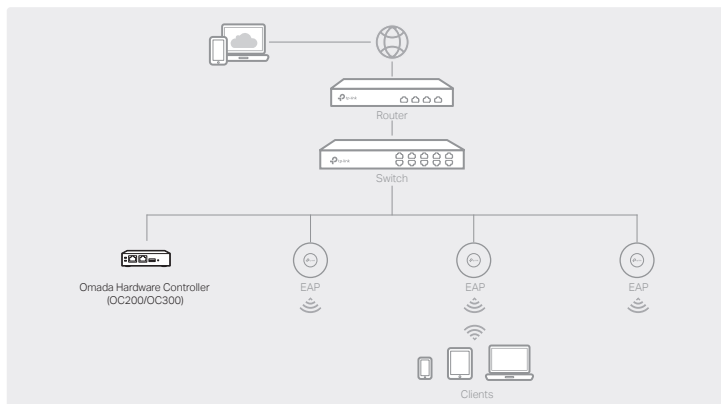

Note:

- Before you start, be sure to power up and connect your devices according to the topology figure.
- A DHCP server (typically a router with DHCP function enabled) is required to assign IP addresses to the EAPs and clients in your local network.
- Omada Controller must have network access to your Omada devices (the router, switch, and EAPs) in order to find, adopt, and manage them.

• Type 2: Omada Software Controller

On a PC with Windows OS or Linux OS, download the Omada Software Controller from <https://www.tp-link.com/support/download/omada-software-controller/>. Then run the file and follow the wizard to install and launch the Omada Software Controller. To manage your devices, Omada Software Controller needs to keep running on your computer.

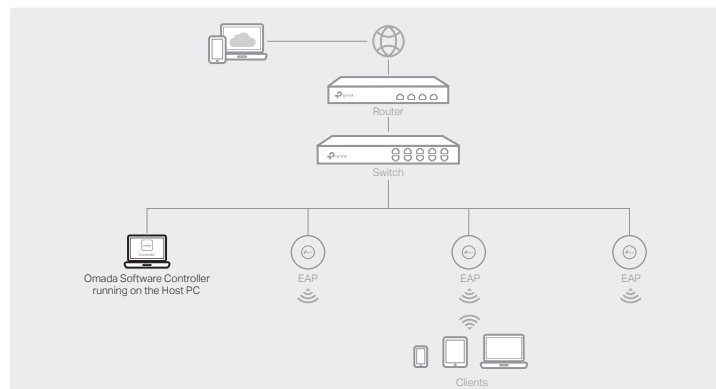

Choose from the following two types of Management Interface:

• Type 1: Via Web Browser

1. Open the Omada Controller's web page.

* For Omada Software Controller
Launch the Omada Software Controller on your PC. After the initiation process, the controller automatically opens its web page. If not, click **Launch a Browser to Manage the Network**.

* For Omada Hardware Controller

As Omada Hardware Controller gets its IP address from the DHCP server of the router, we don't know its IP address explicitly. However, we can find it out on the router's DHCP client list.

- a. You need first find the IP address of the router. Open the command line on your PC and enter `ipconfig`. In the result list, find the **Default Gateway**, which is also the IP address of the router.
 - b. Launch a web browser and enter the IP address of the router. Log into the router's web page, and both the username and password are **admin** by default. Then go to **Network > LAN > DHCP Client List** to find the IP address of your controller according to its MAC address.
 - c. Enter the IP address of your controller in address bar to open its web page.
2. On the Omada Controller's page, follow the wizard to complete the quick setup.
 3. After quick setup, login page appears. Enter the username and password you have created and click **Log in**. Then you can further configure the controller.
 4. (For Remote Management) You can remotely access and manage your controller via Omada Cloud Service.

Note: Before you start, make sure that both your controller and your PC can access the internet.

* For Omada Software Controller, refer to its User Guide

* For Omada Hardware Controller

- a. Make sure **Cloud Access** is enabled on your controller. By default, **Cloud Access** is enabled. Make sure that the Cloud LED is flashing slowly.
- b. Launch a web browser and enter <https://omada.tp-linkcloud.com> in the address bar. Enter your TP-Link ID and password to log in. Click **+ Add Controller** and choose **Hardware Controller** to add your controller.

• Type 2: Via Omada App

1. Download the TP-Link Omada App on your mobile device. It can be downloaded from App Store or Google Play:



2. Launch your Omada App and configure the controller at a local site or remote site.

• Local Management

- a. Connect your mobile device to the EAP by using the default SSID (format: **TP-Link_2.4GHz/5GHz_XXXXXX**) printed on the label at the bottom of the product.
- b. Launch Omada App and go to **Local Access**, tap the **+** button on the upper-right corner to add the controller. Then you can further configure the controller.

• Remote Management

Note: Before you start, make sure that both your controller and mobile device can access the internet.

* For Omada Software Controller

- a. Make sure that **Cloud Access** is enabled on your controller and your controller has been bound with your TP-Link ID.
- b. Launch Omada App and log in with your TP-Link ID. Then go to **Cloud Access**. A list of controllers that have been bound with your TP-Link ID will appear. Then you can further configure the controller.

* For Omada Hardware Controller

- a. Make sure that **Cloud Access** is enabled on your controller. By default, **Cloud Access** is enabled. Make sure that the Cloud LED is flashing slowly.
- b. Launch Omada App and log in with your TP-Link ID. Then go to **Cloud Access**. Tap the **+** button on the upper-right to add your controller. Then you can further configure the controller.

 To ask questions, find answers, and communicate with TP-Link users or engineers, please visit <https://community.tp-link.com> to join TP-Link Community.

 For technical support and other information, please visit <https://www.tp-link.com/support>, or simply scan the QR code.

 If you have any suggestions or needs on the product guides, welcome to email techwriter@tp-link.com.cn.



UKCA Declaration of Conformity

TP-Link hereby declares that the device is in compliance with the essential requirements and other relevant provisions of the Electromagnetic Compatibility Regulations 2016 and Electrical Equipment (Safety) Regulations 2016.

The original UKCA declaration of conformity may be found at <https://www.tp-link.com/uk/ukca>

Safety Information

- Keep the device away from water, fire, humidity or hot environments.
- Do not attempt to disassemble, repair, or modify the device. If you need service, please contact us.
- Do not use damaged charger or USB cable to charge the device.
- Do not use any other chargers than those recommended.
- Adapter shall be installed near the equipment and shall be easily accessible.
- Place the device with its bottom surface downward.
- The plug on the power supply cord is used as the disconnect device, the socket-outlet shall be easily accessible.

EU Declaration of Conformity

TP-Link hereby declares that the device is in compliance with the essential requirements and other relevant provisions of directives 2014/30/EU, 2014/35/EU, 2009/125/EC, 2011/65/EU and (EU)2015/863.

The original EU declaration of conformity may be found at <https://www.tp-link.com/en/support/ce/>

