

Network Video Recorder Series

Quick Start Guide

V5.2.3

Cybersecurity Recommendations

Mandatory actions to be taken towards cybersecurity

1. Change Passwords and Use Strong Passwords:

The number one reason systems get “hacked” is due to having weak or default passwords. It is recommended to change default passwords immediately and choose a strong password whenever possible. A strong password should be made up of at least 8 characters and a combination of special characters, numbers, and upper and lower case letters.

2. Update Firmware

As is standard procedure in the tech-industry, we recommend keeping NVR, DVR, and IP camera firmware up-to-date to ensure the system is current with the latest security patches and fixes.

“Nice to have” recommendations to improve your network security

1. Change Passwords Regularly

Regularly change the credentials to your devices to help ensure that only authorized users are able to access the system.

2. Change Default HTTP and TCP Ports:

- Change default HTTP and TCP ports for systems. These are the two ports used to communicate and to view video feeds remotely.
- These ports can be changed to any set of numbers between 1025-65535. Avoiding the default ports reduces the risk of outsiders being able to guess which ports you are using.

3. Enable HTTPS/SSL:

Set up an SSL Certificate to enable HTTPS. This will encrypt all communication between your devices and recorder.

4. Enable IP Filter:

Enabling your IP filter will prevent everyone, except those with specified IP addresses, from accessing the system.

5. Change ONVIF Password:

On older IP Camera firmware, the ONVIF password does not change when you change the system’s credentials. You will need to either update the camera’s firmware to the latest revision or manually change the ONVIF password.

6. Forward Only Ports You Need:

- Only forward the HTTP and TCP ports that you need to use. Do not forward a huge range of numbers to the device. Do not DMZ the device's IP address.
- You do not need to forward any ports for individual cameras if they are all connected to a recorder on site; just the NVR is needed.

7. Disable Auto-Login on SmartPSS:

Those using SmartPSS to view their system and on a computer that is used by multiple people should disable auto-login. This adds a layer of security to prevent users without the appropriate credentials from accessing the system.

8. Use a Different Username and Password for SmartPSS:

In the event that your social media, bank, email, etc. account is compromised, you would not want someone collecting those passwords and trying them out on your video surveillance system. Using a different username and password for your security system will make it more difficult for someone to guess their way into your system.

9. Limit Features of Guest Accounts:

If your system is set up for multiple users, ensure that each user only has rights to features and functions they need to use to perform their job.

10. UPnP:

- UPnP will automatically try to forward ports in your router or modem. Normally this would be a good thing. However, if your system automatically forwards the ports and you leave the credentials defaulted, you may end up with unwanted visitors.
- If you manually forwarded the HTTP and TCP ports in your router/modem, this feature should be turned off regardless. Disabling UPnP is recommended when the function is not used in real applications.

11. SNMP:

Disable SNMP if you are not using it. If you are using SNMP, you should do so only temporarily, for tracing and testing purposes only.

12. Multicast:

Multicast is used to share video streams between two recorders. Currently there are no known issues involving Multicast, but if you are not using this feature, deactivation can enhance your network security.

13. Check the Log:

If you suspect that someone has gained unauthorized access to your system, you can check the system log. The system log will show you which IP addresses were used to login to your system and what was accessed.

14. Physically Lock Down the Device:

Ideally, you want to prevent any unauthorized physical access to your system. The best way to achieve this is to install the recorder in a lockbox, locking server rack, or in a room that is behind a lock and key.

15. Connect IP Cameras to the PoE Ports on the Back of an NVR:

Cameras connected to the PoE ports on the back of an NVR are isolated from the outside world and cannot be accessed directly.

16. Isolate NVR and IP Camera Network

The network your NVR and IP camera resides on should not be the same network as your public computer network. This will prevent any visitors or unwanted guests from getting access to the same network the security system needs in order to function properly.

Table of Contents

1	INSTALLATION AND CONNECTIONS	1
1.1	Check Unpacked NVR.....	1
1.2	Front Panel.....	1
1.2.1	Super 3U NVR / Super 4K 3U NVR/ Super 4K S2 3U NVR Series	1
1.2.2	Super 4K 2U NVR/ Super 4K S2 2U NVR Series	2
1.2.3	Super 4U NVR Series	6
1.3	Rear Panel.....	7
1.3.1	Super 3U NVR Series	7
1.3.2	Super 4K 2U/Super 4K S2 2U NVR Series	8
1.3.3	Super 4K 3U NVR Series	9
1.3.4	Super 4K S2 3U NVR Series	10
1.3.5	Super 4U NVR Series	12
2	OVERVIEW OF NAVIGATION AND CONTROLS.....	14
2.1	Boot up.....	14
2.2	Login & Change Password	14
2.2.1	Login	14
2.2.2	Change Password	15
2.3	Preview	16
2.3.1	Preview Interface	16
2.3.2	Preview Control Bar	17
2.4	Search & Playback.....	17
2.5	Network.....	22
2.6	Remote Device	25

2.7 Shutdown.....28









3 WEB OPERATION30

General

This quick start guide (hereinafter referred to be "the Guide") introduces the functions and operations of the Network Video Recorder (NVR) devices (hereinafter referred to be "the Device").

Safety Instructions

The following categorized signal words with defined meaning might appear in the Guide.

Signal Words	Meaning
 DANGER	Indicates a high potential hazard which, if not avoided, will result in death or serious injury.
 WARNING	Indicates a medium or low potential hazard which, if not avoided, could result in slight or moderate injury.
 CAUTION	Indicates a potential risk which, if not avoided, could result in property damage, data loss, lower performance, or unpredictable result.
 ELECTRICITY	Indicates dangerous high voltage. Take care to avoid coming into contact with electricity.
 LASER BEAM	Indicates a laser radiation hazard. Take care to avoid exposure to a laser beam.
 ESD	Electrostatic Sensitive Devices. Indicates a device that is sensitive to electrostatic discharge.
 TIPS	Provides methods to help you solve a problem or save you time.
 NOTE	Provides additional information as the emphasis and supplement to the text.

Privacy Protection Notice

As the device user or data controller, you might collect personal data of others' such as face, fingerprints, car plate number, Email address, phone number, GPS and so on. You need to be in compliance with the local privacy protection laws and regulations to protect the legitimate rights and interests of other people by implementing measures include but not limited to: providing clear and visible

identification to inform data subject the existence of surveillance area and providing related contact.

About the Guide

- The Guide is for reference only. If there is inconsistency between the Guide and the actual product, the actual product shall govern.
- We are not liable for any loss caused by the operations that do not comply with the Guide.
- All the designs and software are subject to change without prior written notice. The product updates might cause some differences between the actual product and the Guide. Please contact the customer service for the latest program and supplementary documentation.
- There still might be deviation in technical data, functions and operations description, or errors in print. If there is any doubt or dispute, please refer to our final explanation.
- Upgrade the reader software or try other mainstream reader software if the Guide (in PDF format) cannot be opened.
- All trademarks, registered trademarks and the company names in the Guide are the properties of their respective owners.
- Please visit our website, contact the supplier or customer service if there is any problem occurred when using the device.
- If there is any uncertainty or controversy, please refer to our final explanation.

Important Safeguards and Warnings

The following description is the correct application method of the device. Read the Guide carefully before use to prevent danger and property loss. Strictly conform to the Guide during application and keep it properly after reading.

Operating Requirement

- Don't place and install the device in an area exposed to direct sunlight or near heat generating device.
- Don't install the device in a humid, dusty or fuliginous area.
- Keep its horizontal installation, or install it at stable places, and prevent it from falling.
- Don't drip or splash liquids onto the device; don't put on the device anything filled with liquids, in order to prevent liquids from flowing into the device.
- Install the device at well-ventilated places; don't block its ventilation opening.
- Use the device only within rated input and output range.
- Don't dismantle the device arbitrarily.
- Transport, use and store the device within allowed humidity and temperature range.

Power Requirement

- Make sure to use batteries according to requirements; otherwise, it may result in fire, explosion or burning risks of batteries!
- To replace batteries, only the same type of batteries can be used.
- The product shall use electric wires (power wires) recommended by this area, which shall be used within its rated specification.
- Make sure to use standard power adapter matched with this device. Otherwise, the user shall undertake resulting personnel injuries or device damages.
- Use power supply that meets SELV (safety extra low voltage) requirements, and supply power with rated voltage that conforms to Limited Power Source in IEC60950-1. For specific power supply requirements, please refer to device labels.
- Products with category I structure shall be connected to grid power output socket, which is equipped with protective grounding.
- Appliance coupler is a disconnecting device. During normal use, please keep an angle that facilitates operation.

1 Installation and Connections

Note: All the installation and operations here should conform to your local electric safety rules.

1.1 Check Unpacked NVR

When you receive the NVR from the forwarding agent, please check whether there is any visible damage. The protective materials used for the package of the NVR can protect most accidental clashes during transportation. Then you can open the box to check the accessories. Please check the items in accordance with the list. Finally you can remove the protective film of the NVR.

1.2 Front Panel

1.2.1 Super 3U NVR / Super 4K 3U NVR/ Super 4K S2 3U NVR Series

For the product of LCD, the front panel of super 3U NVR/super 4K 3U NVR is shown as below. See Figure 1-1.

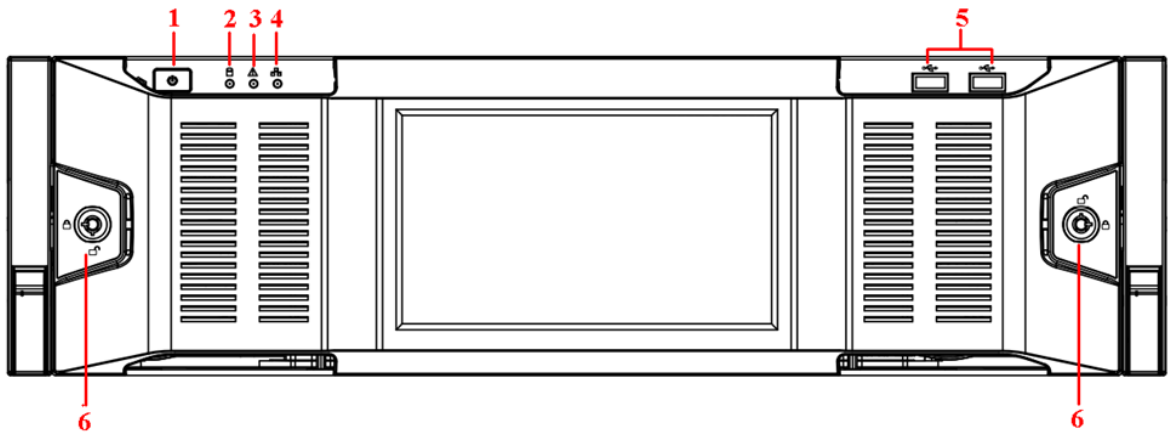

Figure 1-1

Please refer to the following sheet for front panel button information.

SN	Name	Function
1	Power button	Press it once to turn on the device. Press it for a long time to turn off the device. (Usually we do not recommend) . Press power button for a long time or pull out the power cable may result in device auto restart.
2	System HDD Indicator light	The blue light becomes on after system booted up properly. In the system HDD, there are device important configuration file, factory default configuration file, and device initial boot up data.
3	Alarm indicator light	The alarm indicator light becomes on once an alarm occurred. It becomes on via the software detection. The indicator light becomes on when there is a local alarm.
4	Network	The blue network indicator light is on after you connected the device

	indicator light	to the network.
5	USB port	Connect to USB device, mouse, burner and etc.
6	Front panel lock	Secure it to lock the panel. It has the dustproof function. It can reduce the risk of the HDD stealing or mistakenly remove operation.

For general super 3U NVR/super 4K 3U NVR series, the front panel is shown as in Figure 1-2.

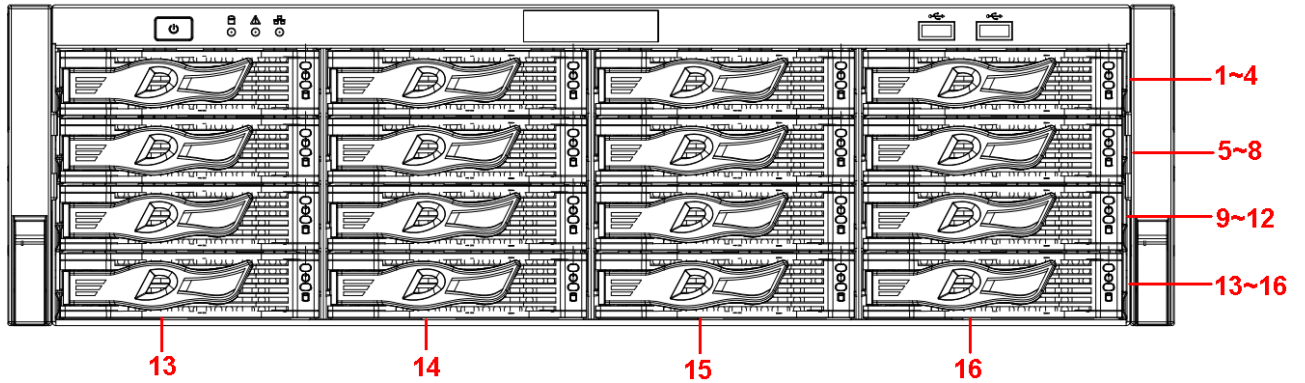

Figure 1-2

After you remove the front panel, you can see there are 16 HDDs. From the left to the right and from the top to the bottom, it ranges from 1~4, 5~8, 9~12, 13~16.

You can see there are two indicator lights on the HDD bracket.

- The power indicator light is at the top. The light is yellow after you connected the device to the power.
- The read-write indicator light is at the bottom. The blue light flashes when system is reading or writing the data.

1.2.2 Super 4K 2U NVR/ Super 4K S2 2U NVR Series

The super 4K 2U 64/128-channel NVR front panel is shown as in Figure 1-3.

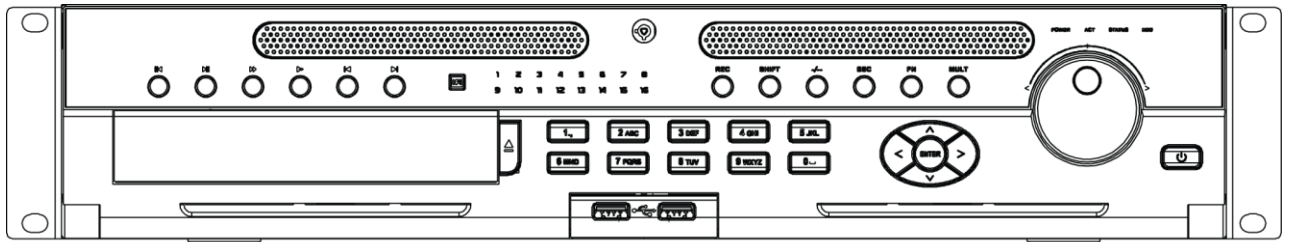







Figure 1-3

Please refer to the following sheet for detailed information.

Name	Icon	Function
Power button		Power button, press this button for three seconds to boot up or shut down NVR.

Number button	0-9 and etc	Input Arabic number Switch channel
Record	REC	Manually stop/start recording, working with direction keys or numeral keys to select the recording channel.
Input number more than 10	-/--	If you want to input a number more than 10, please click this button and then input.
ESC	ESC	Go to previous menu, or cancel current operation.
		When playback, click it to restore real-time monitor mode.
Assistant	Fn	One-window monitor mode, click this button to display assistant function: PTZ control and image color.
		Backspace function: in numeral control or text control, press it for 1.5seconds to delete the previous character before the cursor.
		In motion detection setup, working with Fn and direction keys to realize setup.
		In text mode, click it to switch between numeral, English character(small/capitalized) and etc.
		In HDD management interface, you can click it to switch HDD record information and other information (Menu prompt)
		Realize other special functions.
Window switch	Mult	Click it to switch one-window/multiple-window.
Shift	↑	In textbox, click this button to switch between numeral, English(Small/Capitalized),donation and etc.
		Enable or disable tour.
Up/ Down	▲ ▼	Activate current control, modify setup, and then move up and down.
		Increase/decrease numeral.
		Assistant function such as PTZ menu.
Left/ Right	◀ ▶	Shift current activated control, and then move left and right.
		When playback, click these buttons to control playback bar.
Slow play	▶	Multiple slow play speeds or normal playback.
Fast play	▶▶	Various fast speeds and normal playback.
Play previous	◀	In playback mode, playback the previous video.

Reverse/Pause		In normal playback or pause mode, click this button to reverse playback In reverse playback, click this button to pause playback.
Play Next		In playback mode, playback the next video
Play/Pause		In normal playback click this button to pause playback. In pause mode, click this button to resume playback. In backward playback or pause mode, click this button to resume normal playback. In real-time monitor mode, click this button to go to the search menu.
Enter	ENTER	Confirm current operation
		Go to default button
		Go to menu
Shuttle(outer ring)		In real-time monitor mode it works as left/right direction key. Playback mode, counter clockwise to forward and clock wise to backward.
Jog(inner dial)		Up/down direction key. Playback mode, turn the inner dial to realized frame by frame playback. (Only applies to some special versions.)
USB port		To connect USB storage device, USB mouse and etc.
Channel indicator light	1-16	It becomes on when system is recording.
IR Receiver	IR	It is to receive the signal from the remote control.
Power indicator light	POWER	Power indicator light.
Remote control indicator light	ACT	Remote control indicator light.
Status indicator light	STATUS	If there is Fn indicator light, current status indicator light is null.
HDD abnormal indicator light	HDD	The indicator light is on when there is no HDD, HDD error occurred or HDD capacity is below specified threshold value.

The super 4K 2U 32-channel/ super 4K S2 2U 32-channel NVR front panel is shown as in Figure 1-4.

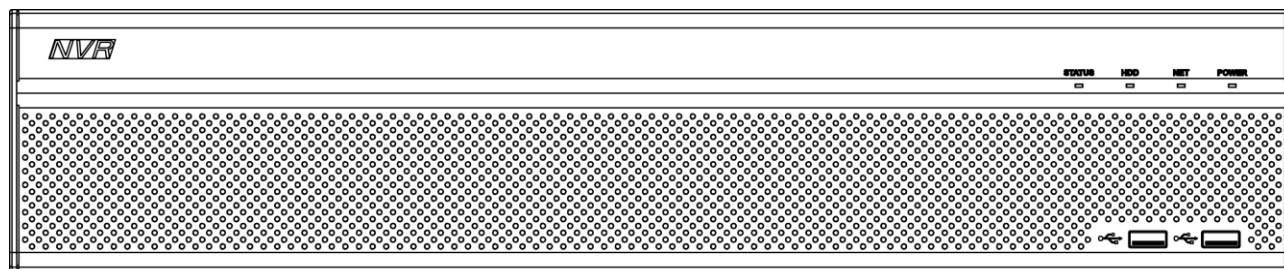



Figure 1-4

Please refer to the following sheet for front panel button information.

Icon	Name	Function
STATUS	Status indicator light	The blue light is on when the device is working properly.
HDD	HDD status indicator light	The blue light is on when the HDD is malfunction.
NET	Network status indicator light	The blue light is on when the network connection is abnormal.
POWER	Power status indicator light	The blue light is on when the power connection is OK.
	USB2.0 port	Connect to peripheral USB 2.0 storage device, mouse, burner and etc.

The super 4K S2 2U 64/128-channel NVR front panel is shown as in Figure 1-5.

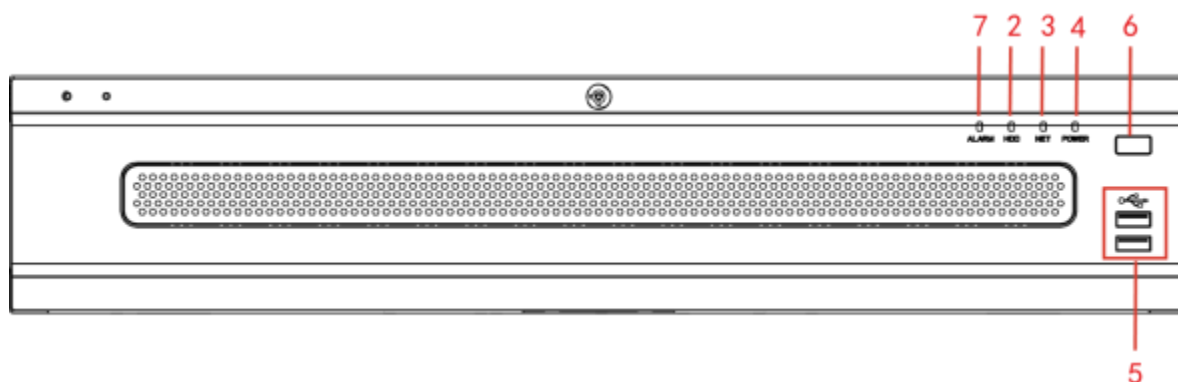



Figure 1-5

Please refer to the following sheet for front panel button information.

SN	Icon	Function	SN	Icon	Function
1	Status	Status indicator light	2	HDD	HDD indicator light
3	NET	Network indicator light	4	Power	Power indicator light
5		USB port	6		Power on-off button
7	ALARM	Alarm indicator light	-	-	

1.2.3 Super 4U NVR Series

For the product of the LCD screen, the front panel is shown as in Figure 1-6.

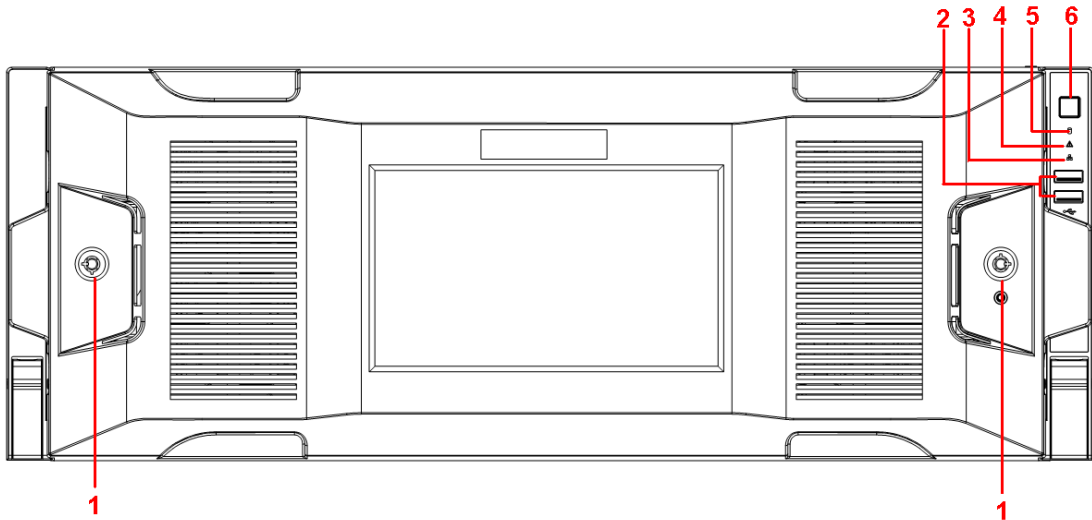









Figure 1-6

SN	Icon	Name	Function
1		Front panel lock	Secure it to lock the panel. It has the dustproof function. It can reduce the risk of the HDD stealing or mistakenly remove operation.
2		USB port	Connect to USB device, mouse, burner and etc.
3		Network indicator light	The network indicator light is blue and it flashes when you connect the device to the network.
4		Alarm indicator light	The alarm indicator light becomes on once an alarm occurred. It becomes on via the software detection. The alarm includes local alarm, no disk and etc.
5		System HDD Indicator light	The blue light becomes on when system is reading or writing the system HDD. In the system HDD, there are device important configuration file, factory default configuration file, device initial boot up data.
6		Power button	Press it once to turn on the device. Press it for a long time to turn off the device (Usually we do not recommend). Press power button for a long time or pull out the power cable may result in device auto restart.

After you remove the front panel, you can see there are 24 HDDs. From the left to the right and

from the top to the bottom, it ranges from 1~4, 5~8, 9~12, 13~16, 17~20, 21~24. See Figure 1-7.

You can see there are two indicator lights on the HDD bracket.

- : The power indicator light is at the top. The light is yellow after you connected the device to the power.
- : The read-write indicator light is at the bottom. The blue light flashes when system is reading or writing the data.

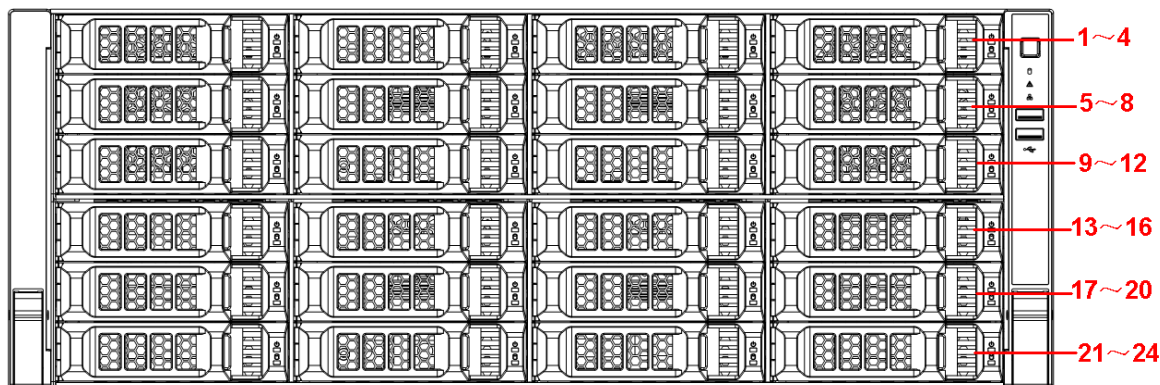

Figure 1-7

1.3 Rear Panel

1.3.1 Super 3U NVR Series

The general series rear panel of super 3U NVR is shown as in Figure 1-8.

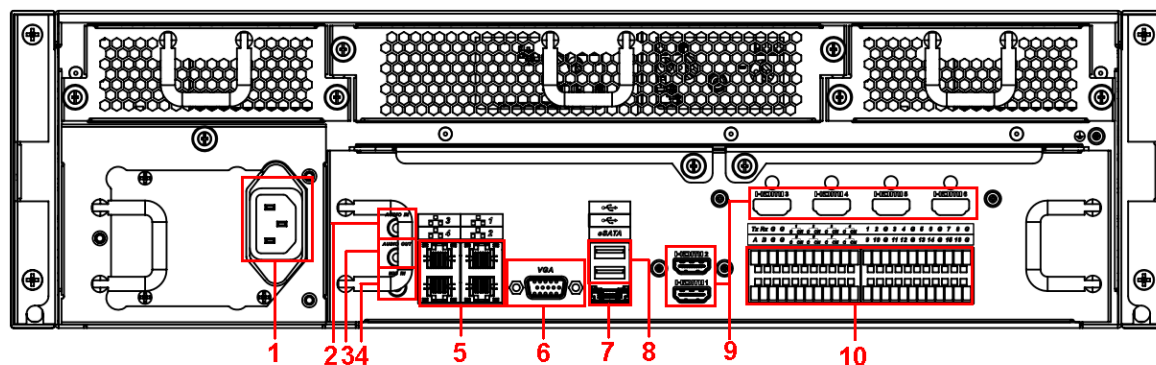

Figure 1-8

The redundant power series rear panel of super 3U NVR is shown as in Figure 1-9.

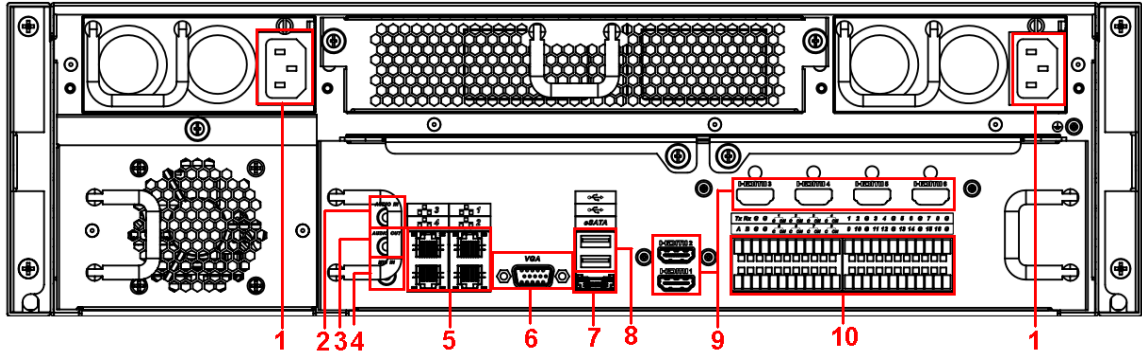

Figure 1-9

Please refer to the following sheet for rear detailed information.

SN	Function	SN	Function
1	Power socket	2	Audio Input
3	Audio output	4	Bidirectional talk input
5	Network port	6	Video VGA output
7	eSATA port	8	USB port
9	HDMI port	10	Alarm input/alarm output/RS485 port.

Important

Right now, system does not support audio input port. System supports HDMI1/HDMI2 port by default. You need to purchase HDMI interface board if you want to use HDMI3-HDMI6 port.

1.3.2 Super 4K 2U/Super 4K S2 2U NVR Series

The super 4K 32-channel 2U/ super 4K S2 32-channel 2U series rear panel is shown as in Figure 1-10.

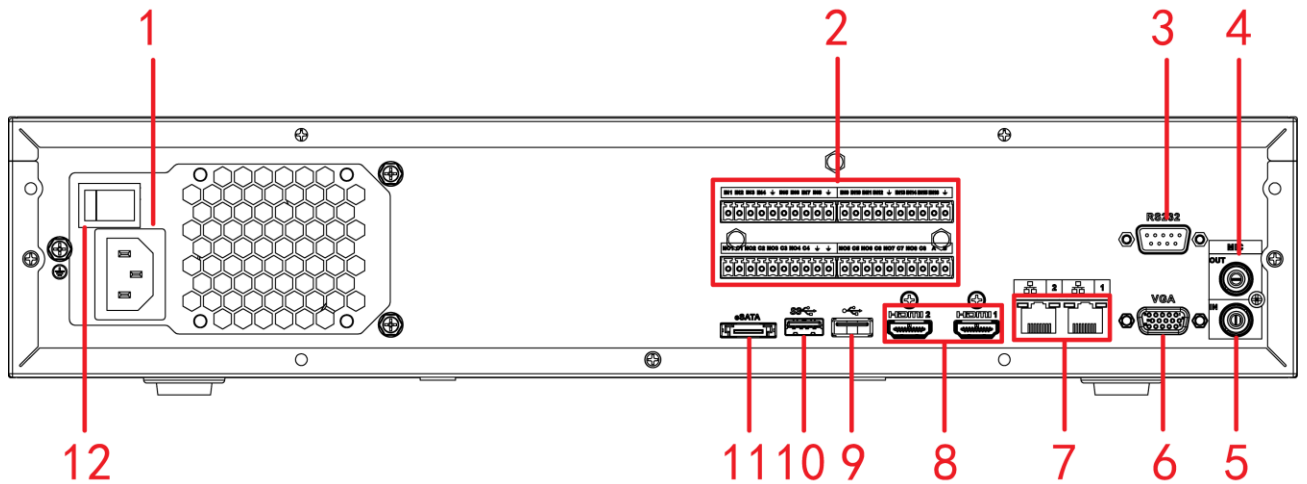

Figure 1-10

The super 4K 64-channel 2U/ super 4K 128-channel 2U/ super 4K S2 64-channel 2U/super 4K S2 128-channel 2U general series rear panel is shown as in Figure 1-11.

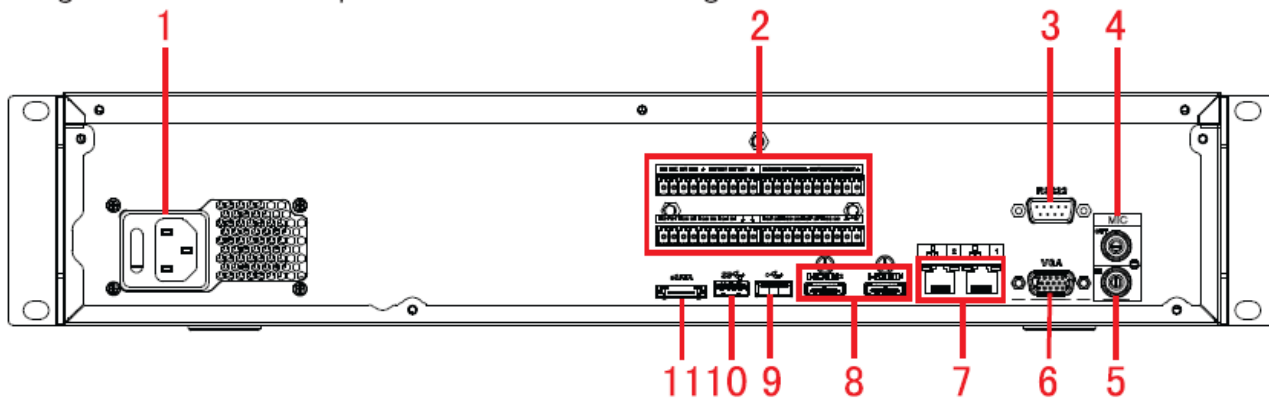

Figure 1-11

The super 4K 64-channel 2U/super 4K 128-channel 2U/ super 4K S2 64-channel 2U/super 4K S2

128-channel 2U redundant power series rear panel is shown as in Figure 1-12.

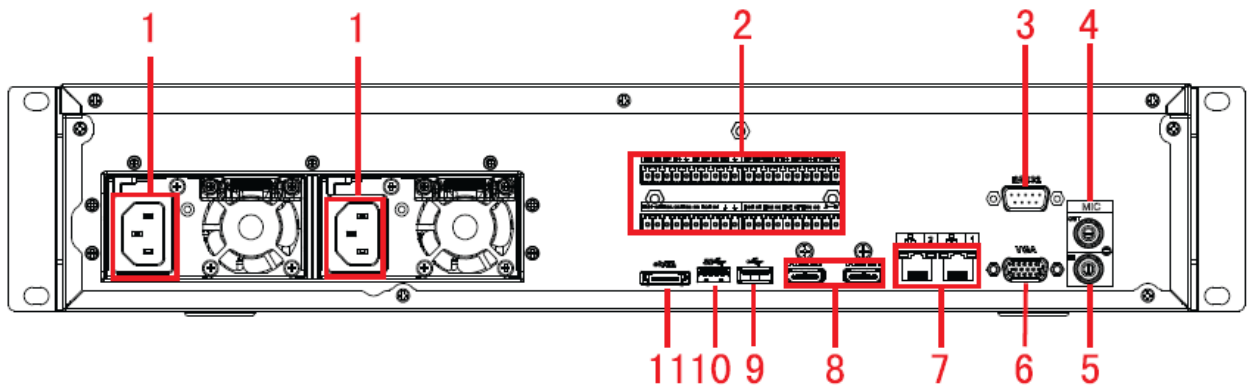

Figure 1-12

Please refer to the following sheet for detailed information.

SN	Function	SN	Function
1	Power socket	2	Alarm input/alarm output/RS485 port.
2	RS232 port	4	Audio output
5	Audio input	6	VGA port
7	Network port	8	HDMI port
9	<ul style="list-style-type: none"> ● Super 4K : USB 2.0 port ● Super 4KS2 : USB 3.0 port 	10	USB 3.0 port
11	eSATA port		

1.3.3 Super 4K 3U NVR Series

The general series rear panel of super 4K 3U is shown as in Figure 1-13.

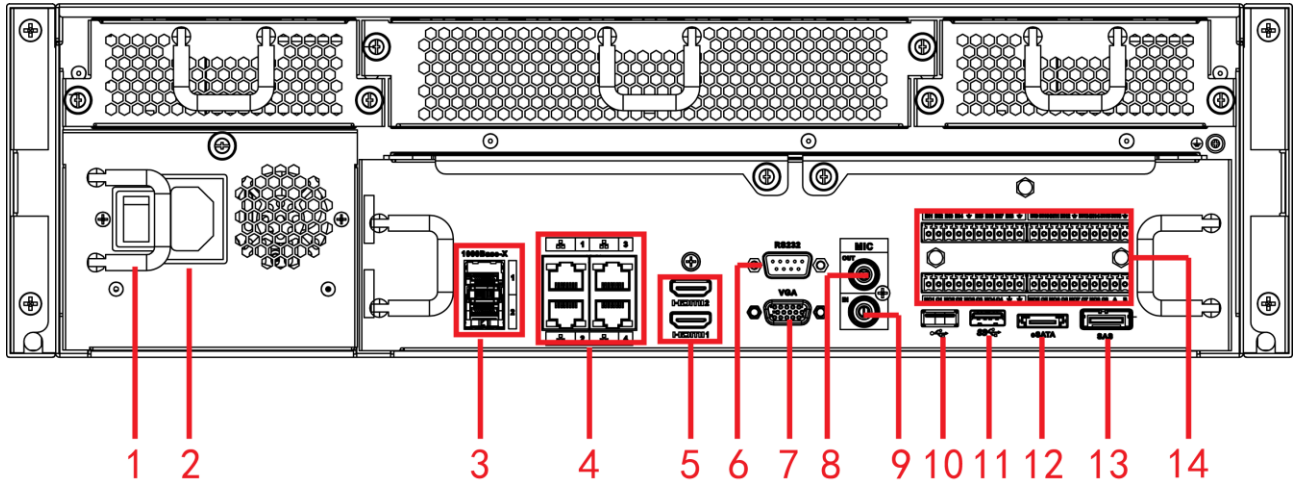

Figure 1-13

The redundant power series rear panel of super 4K 3U is shown as in Figure 1-14.

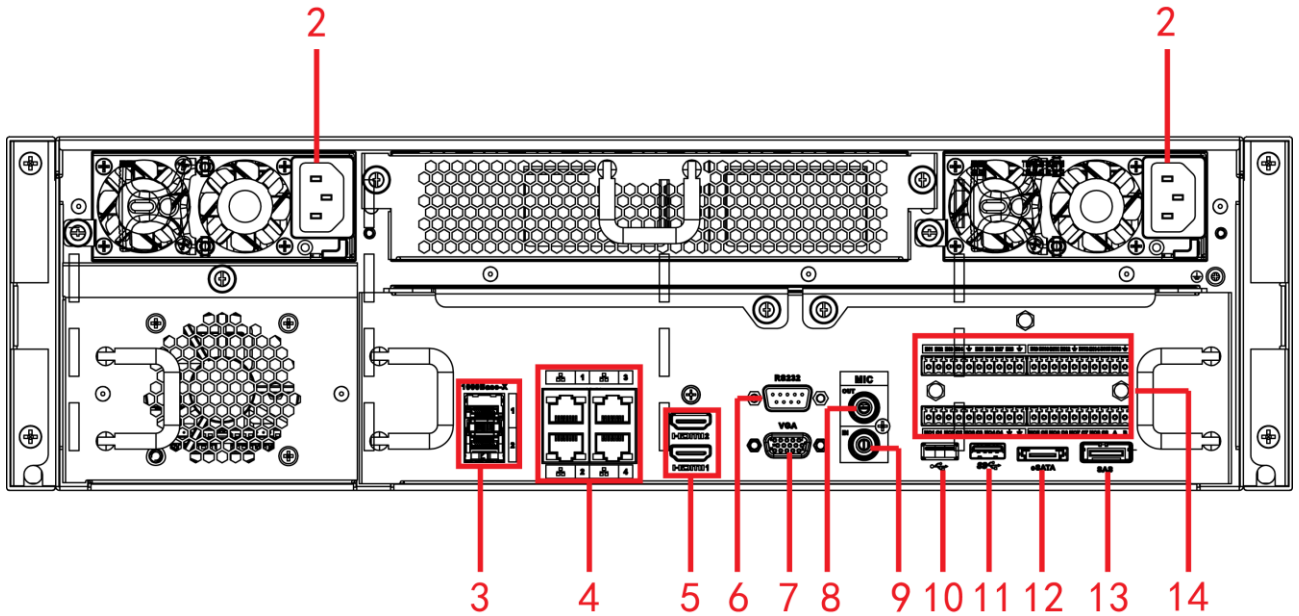

Figure 1-14

Please refer to the following sheet for rear detailed information.

SN	Name	SN	Name
1	Power on-off button	2	Power socket
3	1000M fiber port	4	Network port
5	HDMI port	6	RS232 port
7	Video VGA output	8	Audio output
9	Audio input	10	USB2.0 port
11	USB3.0 port	12	eSATA port
13	SAS extension port	14	Alarm input/output/RS485 port

1.3.4 Super 4K S2 3U NVR Series

The general series rear panel of super 4K S2 3U is shown as in Figure 1-5.

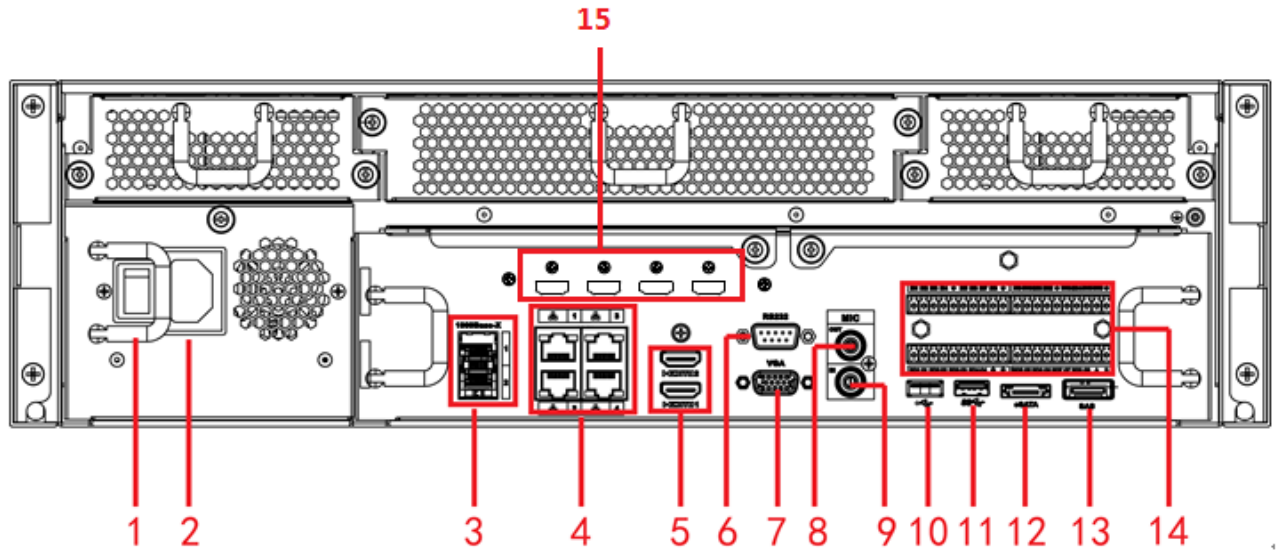

Figure 1-15

The redundant power series rear panel of super 4K S2 3U is shown as in Figure 1-16.

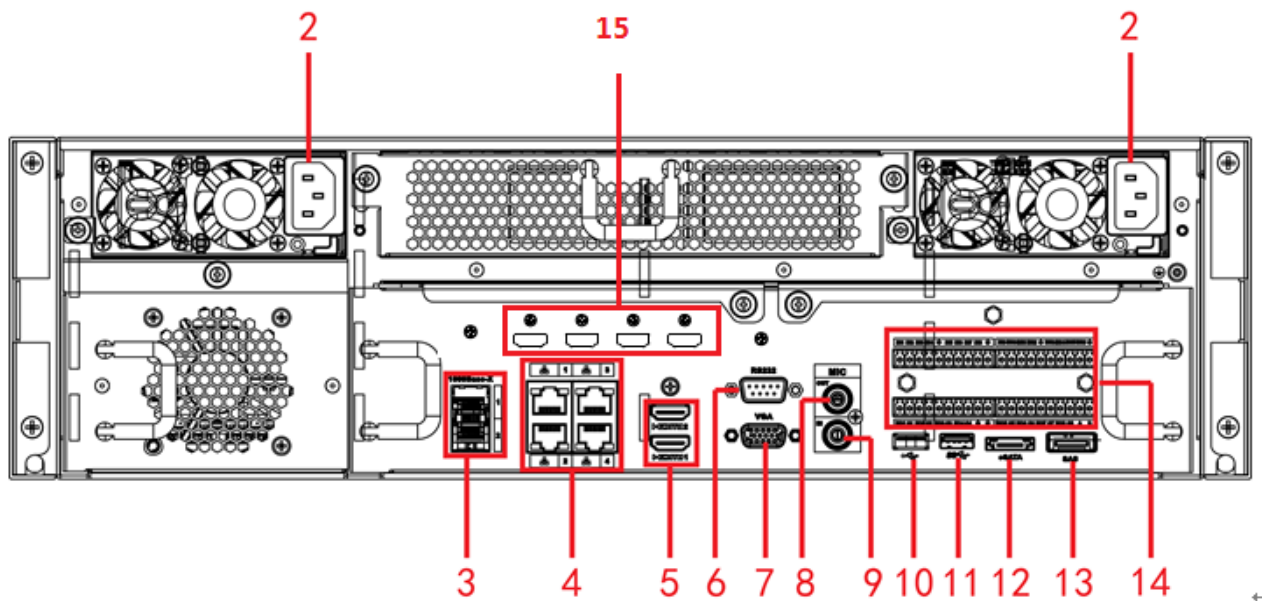

Figure 1-16

Please refer to the following sheet for rear detailed information.

SN	Name	SN	Name
1	Power on-off button	2	Power socket
3	1000M fiber port	4	Network port
5	HDMI port	6	RS232 port
7	Video VGA output	8	Audio output
9	Audio input	10	USB3.0 port
11	USB3.0 port	12	eSATA port
13	SAS extension port	14	Alarm input/output/RS485 port
15	HDMI port HDMI port (The HD		

SN	Name	SN	Name
	decode card is not the default accessory. Please purchase if you want to use)		

1.3.5 Super 4U NVR Series

The general rear panel is shown as in Figure 1-17.

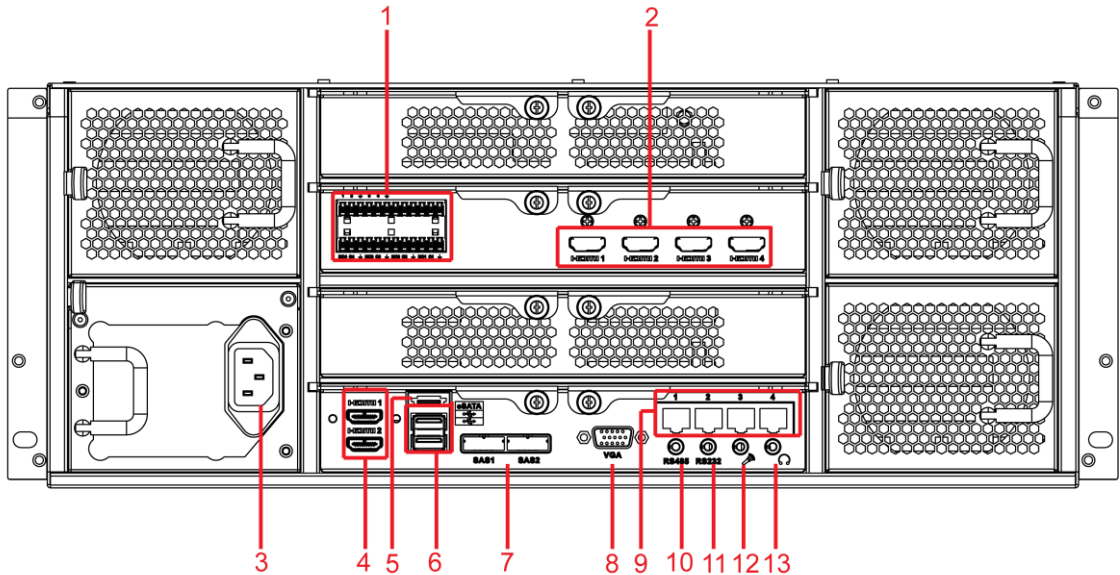

Figure 1-17

The redundant power series rear panel is shown as in Figure 1-18.

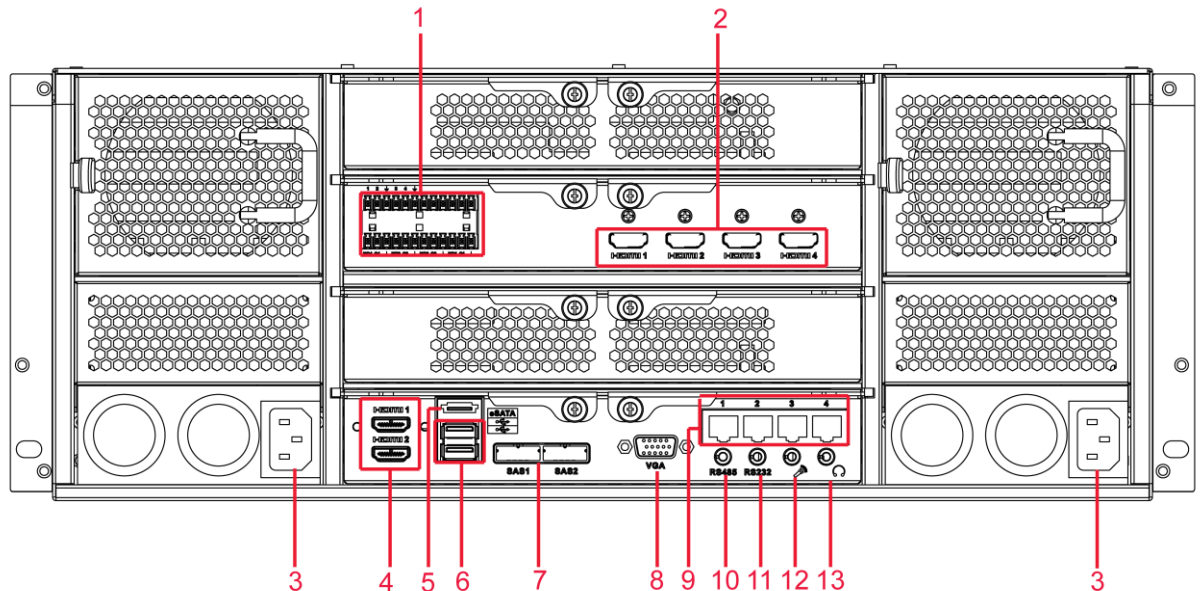

Figure 1-18

Please refer to the following sheet for detailed information.

SN	Name	SN	Name
1	Alarm input/alarm output	2	HDMI port (Reserved port. Right now system does not support HD decode card.)
3	Power port	4	HDMI port
5	eSATA port	6	USB port
7	SAS port	8	Video VGA output
9	Network port	10	RS485 port
11	RS232 port	12	Audio input port
13	Audio output port		

2 Overview of Navigation and Controls

2.1 Boot up



Before operation, please make sure:

- You have properly installed HDD and all the cable connections.
- The provided input power and the device power are matched.
- Always use the stable current, if necessary UPS is a best alternative measure.

Please follow the steps listed below to boot up the device.

- Connect the device to the monitor and then connect a mouse.
- Connect power cable.
- Click the power button at the front or rear panel and then boot up the device. After device booted up, the system is in multiple-channel display mode by default.

2.2 Login & Change Password

2.2.1 Login

After system booted up, system pops up the startup wizard interface. See Figure 2-1.

Please refer to the user's manual for detailed startup wizard operation information.

Tips

Check the box Startup button here, system goes to startup wizard again when it boots up the next time.

Cancel the Startup button, system goes to the login interface directly when it boots up the next time.



Figure 2-1

The system login interface is shown as in Figure 2-2.

System consists of four accounts:

- **Username: admin. Password: admin. (administrator, local and network)**
- **Username: 888888. Password: 888888. (administrator, local only)**
- **Username: 666666. Password: 666666(Lower authority user who can only monitor, playback, backup and etc.)**
- **Username: default. Password: default(hidden user)**

You can use USB mouse, front panel, remote control (not included in the accessory bag) or

keyboard to input. About input method: Click  to switch between numeral, English character (small/capitalized) and denotation.

Note:

For security reason, please modify password after you first login.

Continuous three times login failure will result in system alarm and five times login failure will result in account lock!

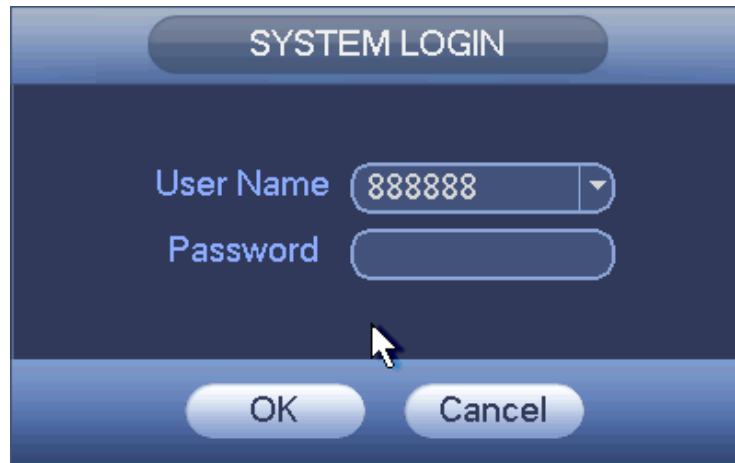

Figure 2-2

2.2.2 Change Password

For your own safety, please change your administrator default password after your first login.

After system booted up, you can see the following interface if it is your first login or you have restored default setup. See Figure 2-3. Please input old password and then input new password twice to confirm the change.

- The default administrator user name is **admin** and the password is **admin**.
- You can set security questions here to reset the password in case you forgot. System supports customized setup. Please note you need to set two security questions at the same time. When you reset the password, you need to answer these two security questions too.
- For reset information, please refer to chapter 3.2.2 of the user's manual .



Figure 2-3

Click Cancel button, system pops up the following interface for you to confirm. See Figure 2-4. Check the box here, system will not pop up the change password interface the next time.

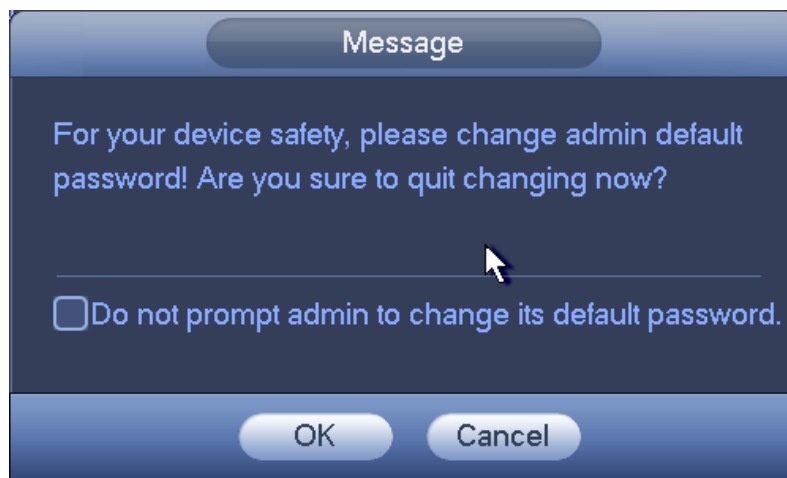







Figure 2-4

2.3 Preview

2.3.1 Preview Interface

After you logged in, the system is in live viewing mode by default. You can see system date, time and channel name. If you want to change system date and time, you can refer to general settings (Main Menu->Setting->System->General). If you want to modify the channel name, please refer to the display settings (Main Menu->Setting->Camera->CAM Name)

1		Current channel pops up this icon when it is	3		Current channel pops up this icon when video loss alarm occurs.
---	---	--	---	---	---

		recording.			
2		Current channel pops up this icon when motion detect alarm occurs.	4		Current channel pops up this icon when it is in monitor lock status.
5		System exceeds decoded channel amount.			

Tips

- Preview drag: If you want to change position of channel 1 and channel 4 when you are previewing, you can left click mouse in the channel 1 and then drag to channel 4, release mouse you can switch channel 1 and channel 4 positions.

2.3.2 Preview Control Bar

Move you mouse to the top centre of the video of current channel, you can see system pops up the preview control interface. See Figure 2-5. If your mouse stays in this area for more than 6 seconds and has no operation, the control bar automatically hides.

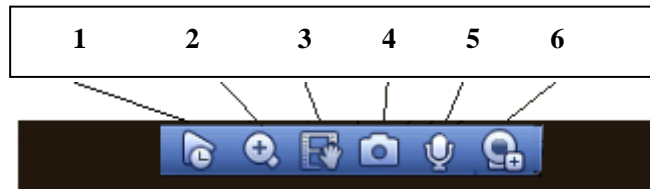

Figure 2-5

You can refer to the following sheet for detailed information.

SN	Name
1	Realtime playback
2	Digital zoom
3	Instant backup function
4	Snapshot
5	Bidirectional talk
6	Remote device

2.4 Search & Playback

Click search button in the main menu, or right click mouse and then select Search button when you are previewing, search interface is shown as below. See Figure 2-6.

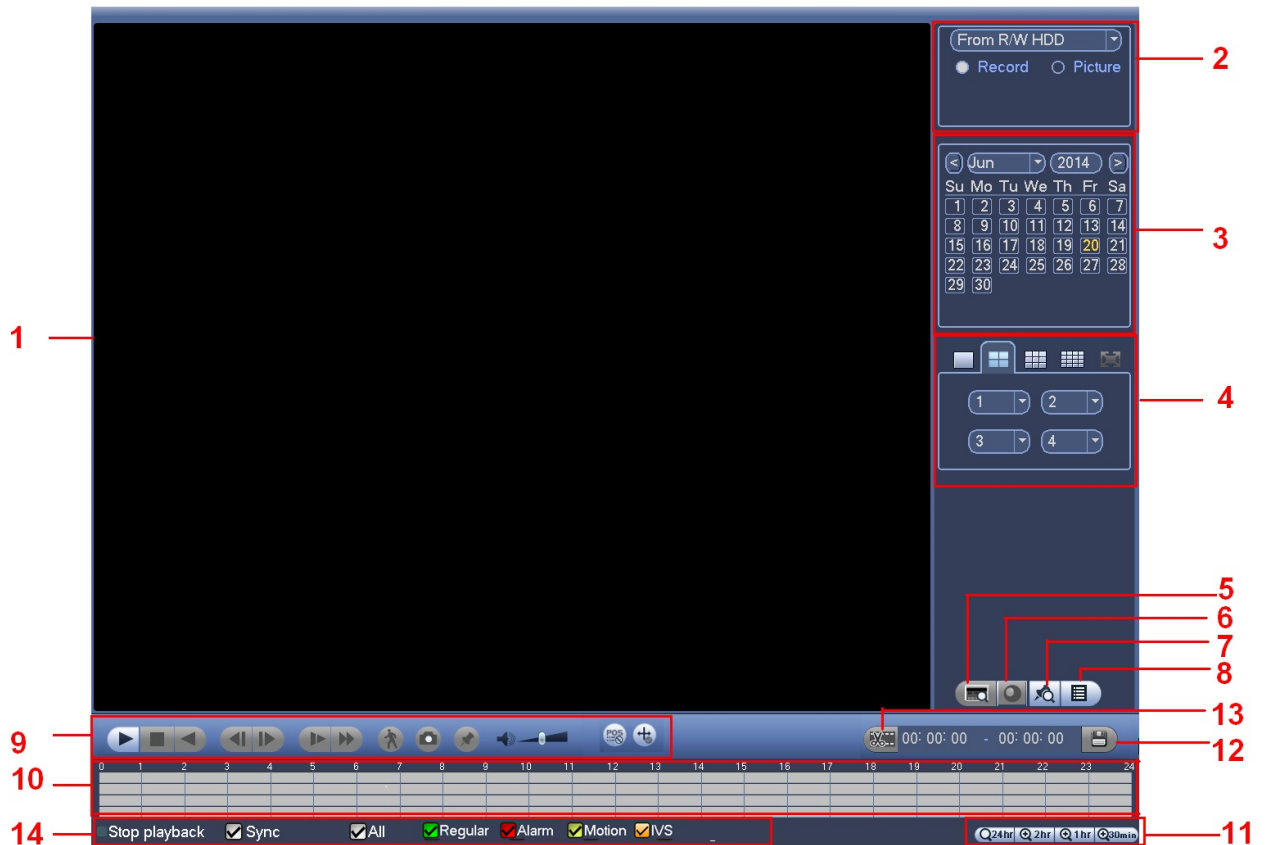

















Figure 2-6

Please refer to the following sheet for more information.

SN	Name	Function
1	Display window	<ul style="list-style-type: none"> ●Here is to display the searched picture or file. ●Support 1/4/9/16-window playback.
2	Search type	<ul style="list-style-type: none"> ●Here you can select to search the picture or the recorded file. ●You can select to play from the read-write HDD, from peripheral device or from redundancy HDD. ●Before you select to play from the peripheral device, please connect the corresponding peripheral device. You can view all record files of the root directory of the peripheral device. Click the Browse button; you can select the file you want to play.
3	Calendar	<ul style="list-style-type: none"> ●The blue highlighted date means there is picture or file. Otherwise, there is no picture or file. ●In any play mode, click the date you want to see, you can see the corresponding record file trace in the time bar.
4	Playback mode and channel selection	<ul style="list-style-type: none"> ●Playback mode: 1/4/9/16. (It may vary due to different series.) ◇ In 1-window playback mode: you can select 1-X channels (X depends on the product channel amount). ◇ In 4-window playback mode: you can select 4 channels according to your requirement.

	pane.	<ul style="list-style-type: none"> ✧ In 9-window playback mode, you can switch between 1-8, 9-16 and etc channels. ✧ In 16-window playback mode, you can switch between 1-16, 17-32 and etc channels. ● The time bar will change once you modify the playback mode or the channel option. 	
5	POS search	In 1-channel playback mode, click it you can set advanced setup.	
6	Fisheye dewarp	In 1-channel playback mode, click it; you can see fisheye setup interface on the right pane. You can set fisheye installation mode and display mode to de-warp the record.	
7	Mark file list button	Click it to go to mark file list interface. You can view all mark information of current channel by time. Please note only the product of this icon supports mark function.	
8	File list switch button	<ul style="list-style-type: none"> ● Double click it, you can view the picture/record file list of current day. ● The file list is to display the first channel of the record file. ● The system can display max 128 files in one time. Click Play button to view the file. Select one item, and then click the mouse or click the Play button to playback. ● You can input the period in the following interface to begin accurate search. ● File type: R—regular record; A—external alarm record; M—Motion detect record.  <ul style="list-style-type: none"> ● Lock file. Click the file you want to lock and click the button  to lock. The file you locked will not be overwritten. ● Search locked file: Click the button  to view the locked file. ● Return: Click button , system goes back to the calendar and channel setup interface. <p>Please note:</p> <ul style="list-style-type: none"> ● For the file that is writing or overwriting, it can not be locked. 	
9	Playback control pane.		<p>Play/Pause</p> <p>There are three ways for you to begin playback.</p> <ul style="list-style-type: none"> ● The play button ● Double click the valid period of the time bar. ● Double click the item in the file list. <p>In slow play mode, click it to switch between play/pause.</p>
			Stop
			<p>Backward play</p> <p>In normal play mode, left click the button, the file begins backward play. Click it again to pause current play.</p>

			In backward play mode, click ►/ to restore normal play.
			In playback mode, click it to play the next or the previous section. You can click continuously when you are watching the files from the same channel. In normal play mode, when you pause current play, you can click ◀ and ▶ to begin frame by frame playback. In frame by frame playback mode, click ►/ to restore normal playback.
			Slow play In playback mode, click it to realize various slow play modes such as slow play 1, slow play 2, and etc.
			Fast forward In playback mode, click to realize various fast play modes such as fast play 1, fast play 2 and etc.
			Note: The actual play speed has relationship with the software version.
			Smart search
			The volume of the playback
			Click the snapshot button in the full-screen mode, the system can snapshot 1 picture. System supports custom snap picture saved path. Please connect the peripheral device first, click snap button on the full-screen mode, you can select or create path. Click Start button, the snapshot picture can be saved to the specified path.
			Mark button. Please note this function is for some series product only. Please make sure there is a mark button in the playback control pane.
			In 1-window playback mode, click it to overlay POS information.
			In 1-window playback mode, click it to overlay IVS rule information.
10	Time bar		<ul style="list-style-type: none"> ●It is to display the record type and its period in current search criteria. ●In 4-window playback mode, there are corresponding four time bars. In other playback mode, there is only one time bar. ●Use the mouse to click one point of the color zone in the time bar, system begins playback. ●The time bar is beginning with 0 o'clock when you are setting the configuration. The time bar zooms in the period of the current playback time when you are playing the file. ●The green color stands for the regular record file. The red color stands for the external alarm record file. The yellow stands for the motion detect record file.
11	Time bar unit		<ul style="list-style-type: none"> ●The option includes: 24H, 12H, 1H and 30M. The smaller the unit, the larger the zoom rate. You can accurately set the time in the time bar to playback the record. ●The time bar is beginning with 0 o'clock when you are setting the configuration.

		The time bar zooms in the period of the current playback time when you are playing the file.
12	Backup	<ul style="list-style-type: none"> ● Select the file(s) you want to backup from the file list. You can check from the list. Then click the backup button, now you can see the backup menu. System supports customized path setup. After select or create new folder, click the Start button to begin the backup operation. The record file(s) will be saved in the specified folder. ● Check the file again you can cancel current selection. System max supports to display 32 files from one channel. ● After you clip on record file, click Backup button you can save it. ● For one device, if there is a backup in process, you can not start a new backup operation.
13	Clip	<ul style="list-style-type: none"> ● It is to edit the file. ● Please play the file you want to edit and then click this button when you want to edit. You can see the corresponding slide bars in the time bar of the corresponding channel. You can adjust the slide bar or input the accurate time to set the file end time. ● After you set, you can click Clip button again to edit the second period. You can see the slide bar restore its previous position. ● Click Backup button after clip, you can save current contents in a new file. ● You can clip for one channel or multiple-channel. The multiple-channel click operation is similar with the one-channel operation. <p>Please note:</p> <ul style="list-style-type: none"> ● System max supports 1024 files backup at the same time. ● You can not operate clip operation if there is any file has been checked in the file list.
14	Record type	In any play mode, the time bar will change once you modify the search type.
Other Functions		
15	Smart motion detect search	<ul style="list-style-type: none"> ● When system is playing, you can select a zone in the window to begin smart search. Click the motion detect button to begin play. ● Once the motion detect play has begun, click button again will terminate current motion detect file play. ● There is no motion detect zone by default. ● If you select to play other file in the file list, system switches to motion detect play of other file. ● During the motion detect play process, you can not implement operations such as change time bar, begin backward playback or frame by frame playback.
16	Sync	In pane 14 of Figure 2-6, click Sync button, you can playback the files of different channels occurred at the same time.
17	Other channel	When playing the file, click the number button, system can switch to the same period of the corresponding channel to play.

	synchroni zation switch to play when playback	
18	Digital zoom	When the system is in full-screen playback mode, left click the mouse in the screen. Drag your mouse in the screen to select a section and then left click mouse to realize digital zoom. You can right click mouse to exit.

Note:

All the operations here (such as playback speed, channel, time and progress) have relationship with hardware version. Some series DVRs do not support some functions or playback speeds.

2.5 Network

From main menu->Setting->Network->TCP/IP, the interface is shown as in Figure 2-7.

- IP Version: There are two options: IPv4 and IPv6. Right now, system supports these two IP address format and you can access via them.
- Preferred DNS server: DNS server IP address.
- Alternate DNS server: DNS server alternate address.
- Default card: It is to set default network card.
- LAN download: System can process the downloaded data first if you enable this function. The download speed is 1.5X or 2.0X of the normal speed.

Important

For the IP address of IPv6 version, default gateway, preferred DNS and alternate DNS, the input value shall be 128-digit. It shall not be left in blank.



Figure 2-7

Click Edit button , you can go to the following interface. See Figure 2-8.

- Network mode:
 - ✧ Single NIC: eth1/eth2/ eth3/eth4 operate separately. You can use the services such as HTTP, RTP service via eth1/eth2/ eth3/eth4. Usually you need to set one default card (default setup is eth1) to request the auto network service from the device-end such as DHCP, email, FTP and etc. In multiple-address mode, system network status is shown as offline once one card is offline.
 - ✧ Network fault-tolerance: In this mode, device uses bond0 to communicate with the external devices. You can focus on one host IP address. At the same time, you need to set one master card. Usually there is only one running card (master card).System can enable alternate card when the master card is malfunction. The system is shown as offline once these cards are offline.
 - ✧ Load balance: In this mode, device uses bond0 to communicate with the external device. The eth1/eth2/ eth3/eth4 are working now and bearing the network load. Their network load are general the same. The system is shown as offline once all cards are offline.
 - ✧ **Note:** Some series product has only eth1 and eth2.
- NIC member: You can check the box here to select the bind cards.
 - ✧ This mode is for fault-tolerance or load balance mode only.
 - ✧ The network cards number shall be equal to or more than 2.
 - ✧ The different types of cards such as fiber card or the Ethernet card can not binding together.

- IP Version: There are two options: IPv4 and IPv6. Right now, system supports these two IP address format and you can access via them.
- MAC address: The host in the LAN can get a unique MAC address. It is for you to access in the LAN. It is read-only.
- IP address: Here you can use up/down button (▲▼) or input the corresponding number to input IP address. Then you can set the corresponding subnet mask the default gateway.
- Default gateway: Here you can input the default gateway. Please note system needs to check the validity of all IPv6 addresses. The IP address and the default gateway shall be in the same IP section. That is to say, the specified length of the subnet prefix shall have the same string.
- DHCP: It is to auto search IP. When enable DHCP function, you can not modify IP/Subnet mask /Gateway. These values are from DHCP function. If you have not enabled DHCP function, IP/Subnet mask/Gateway display as zero. You need to disable DHCP function to view current IP information. Besides, when PPPoE is operating, you can not modify IP/Subnet mask /Gateway.
- MTU: It is to set MTU value of the network adapter. The value ranges from 1280-7200 bytes. The default setup is 1500 bytes. Please note MTU modification may result in network adapter reboot and network becomes off. That is to say, MTU modification can affect current network service. System may pop up dialog box for you to confirm setup when you want to change MTU setup. Click OK button to confirm current reboot, or you can click Cancel button to terminate current modification. Before the modification, you can check the MTU of the gateway; the MTU of the DVR shall be the same as or is lower than the MTU of the gateway. In this way, you can reduce packets and enhance network transmission efficiency. Right now, the value here is for read-only.

The following MTU value is for reference only.

- ◇ 1500: Ethernet information packet max value and it is also the default value. It is the typical setup when there is no PPPoE or VPN. It is the default setup of some router, switch or the network adapter.
- ◇ 1492: Recommend value for PPPoE.
- ◇ 1468: Recommend value for DHCP.

After completing all the setups please click OK button.

Tips

Click button  to cancel card binding.

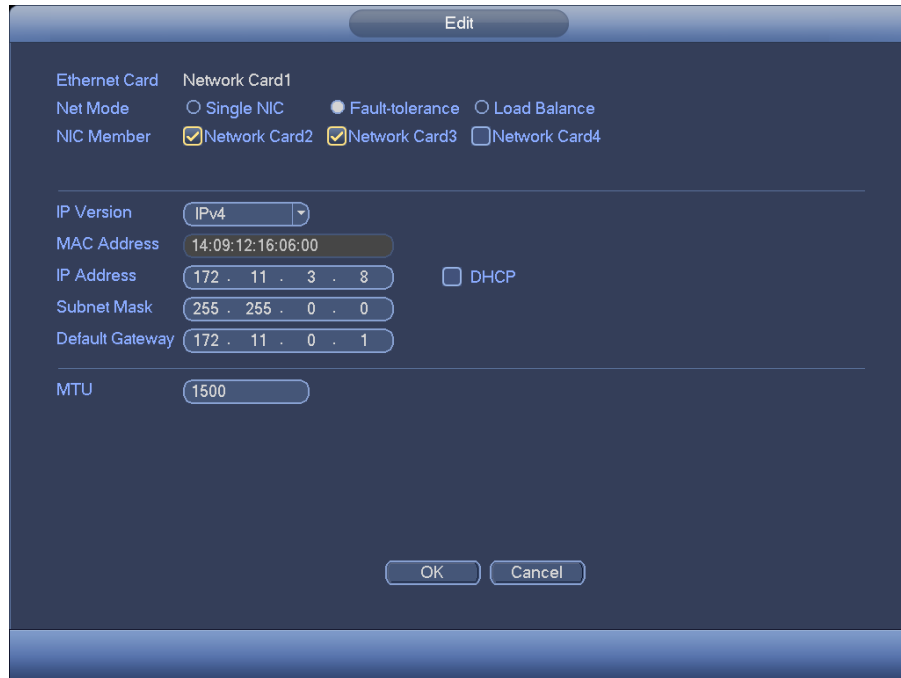

Figure 2-8

2.6 Remote Device

From Main menu->Setting->Camera->Remote->Remote or right click mouse on the preview interface and then select remote item, you can see the following interface. See Figure 2-9.



Figure 2-9

Search remote device

Click Device search button, you can view the searched IP addresses at the top pane of the interface.

Note

- You can use IP address or MAC address to search device. System supports fuzzy search.
- For the device in the added device list, you can not see it at the top pane of the interface

Double click an IP address or check one or more IP address (es) at the same time and then click Add button, you can add current device to the added devices at the bottom pane of the interface. System supports batch add function.

Add remote device

Click Manual Add button, you can add a device directly. Here you can set TCP/UPD/auto connection mode. The default setup is TCP. See Figure 2-10.

- Manufacturer: Select the manufacture from the dropdown list.
- IP address: Input remote IP address.
- TCP port: Input TCP port value.
- User name: Input the user name you login the remote device.
- Password: Input the password you login the remote device.
- Channel amount: It is to display channel total amount. Click Set button to set remote device channel so that you can control remotely.
- Remote channel amount: The channel mount of the remote device.
- Channel: The channel mount of current device. It is the channel amount you want to view the remote device.
- Decode buffer: Please select from the dropdown list: default/realtime/fluency.

Important

Please note the manual add function is for Dahua, Panasonic, Sony, Dynacolor, Samsung, AXIS, Arecont, ONVIF and Custom. When the type is the custom, you can just input URL address, user name and password connect to the network camera without considering network camera manufacture. Please contact your network camera manufacturer for the URL address.



Figure 2-10

Change IP address

On the searched devices list, check one or more device(s) at the same time. Click Modify IP button, you can see the following interface. See Figure 2-11.

- DHCP: Check the box here, system can auto allocate the IP address. The IP address, subnet mask, default gateway are reference only.
- Static: Check the box here, you can set IP address, subnet mask, default gateway manually.
- IP address/subnet mask/default gateway: You can input corresponding information here.
- User name/password: The account you login the remote device. Please input here to password verification to change the remote device password.
- Incremental value: When you want to change several IP addresses, once you input the IP address of the first device, the IP address of the next device will increase accordingly. For example, when the incremental value is 1, if the IP address of the first device is 172.10.3.128, the IP address of the second device will auto be set as 172.10.2.129.

Note

- For the static IP address, system will alert you if there is any IP conflict. If you are changing several IP addresses at the same time, system auto skip the conflicted IP and auto allocate again according to the incremental value you set.

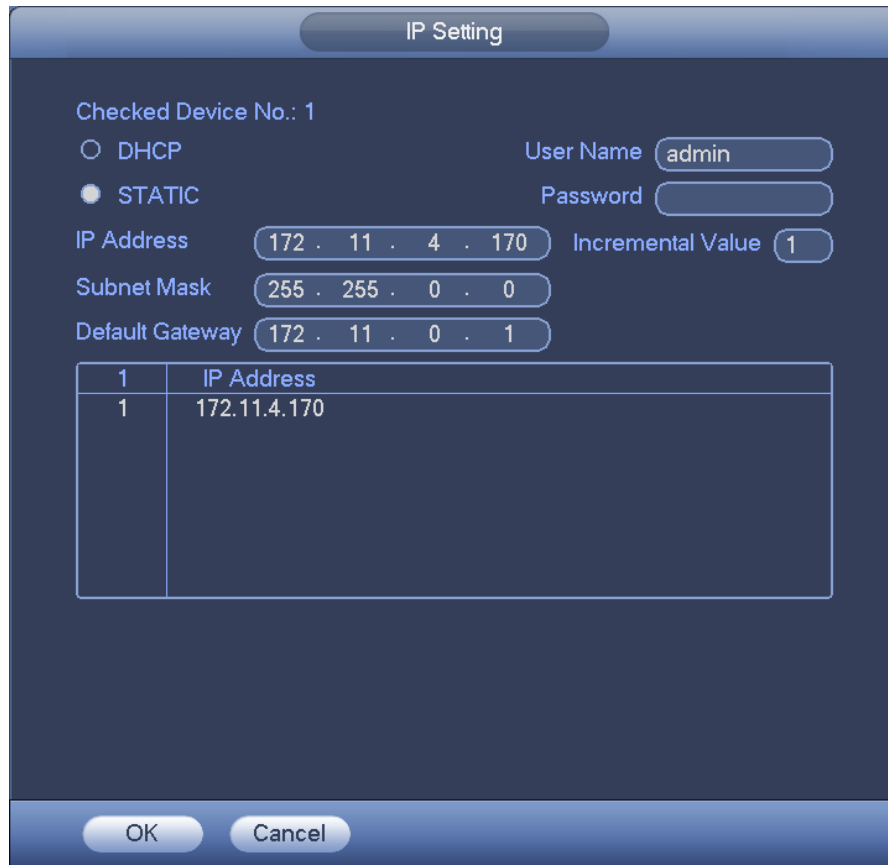

Figure 2-11

2.7 Shutdown

From main menu->operation, double click shutdown button, system pops up a dialogue box for you to select. See Figure 2-12.

- Shutdown: System shuts down and turns off power.
- Logout: Log out menu. You need to input password when you login the next time.
- Restart: Reboot device.

If you shut down the device, you can see system begins saving data and then shut down.

Please note, you can view the corresponding dialogue box if you have no right to turn off the device.



Figure 2-12

3 WEB OPERATION

- 1) Open IE and input NVR address in the address column. For example, if your NVR IP is 10.10.3.16, then please input http:// 10.10.3.16 in IE address column.
- 2) System pops up warning information to ask you whether install webrec.cab control or not. Please click yes button. If you can't download the ActiveX file, please modify your IE security setup. After installation, the interface is shown as below. See Figure 3-1.

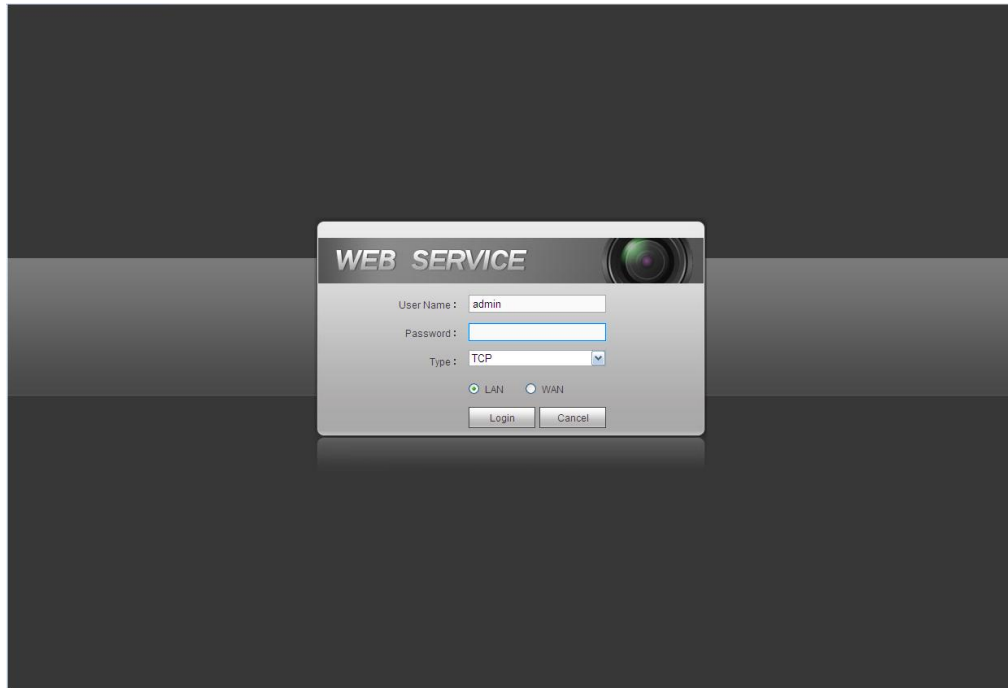

Figure 3-1

- 3) Please input your user name and password. Default factory name is admin and password is admin.

Note:

- For security reasons, please modify your password after you first login.
- For detailed operation instruction, please refer to user's manual included in the resources CD.

Note:

- For detailed operation introduction, please refer to our resource CD included in your package for electronic version of the *User's Manual*.
- This quick start guide is for reference only. Slight difference may be found in the user interface.
- All the designs and software here are subject to change without prior written notice.
- All trademarks and registered trademarks mentioned are the properties of their respective owners.
- If there is any uncertainty or controversy, please refer to the final explanation of us.
- Please visit our website or contact your local retailer for more information.