



# Ascet 5k-6k

Installation Manual  
(Hardware)

SIH12005L032ACCU0B - Ascet 5K-60/1P2T2  
SIH12005L052ACCU0B - Ascet 5K-120/1P2T2  
SIH12006L032ACCU0B - Ascet 6K-60/1P2T2  
SIH12006L062ACCU0B - Ascet 6K-120/1P2T2

Manual de Instalare  
(Hardware)

English

Română

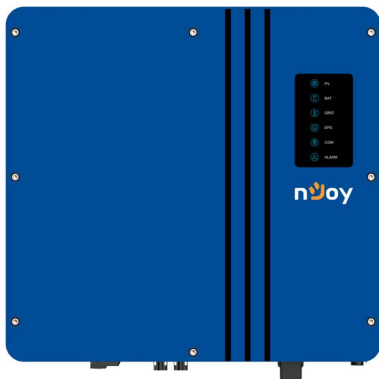

<b>Forward</b>	<b>1</b>
Symbol Conventions	2
<b>Safety</b>	<b>2</b>
1.1 Symbols Used	3
1.2 Safety Precaution	3
<b>Product Introduction</b>	<b>5</b>
2.1 Overview	5
2.2 Product Appearance	7
2.3 Model Definition	9
<b>Installation</b>	<b>10</b>
3.1 Packing List	10
3.2 Selecting the Mounting Location	12
3.3 Mounting	14
<b>Electrical Connection</b>	<b>15</b>
4.1 Inverter's setup connection	15
4.2 Grounding	20
4.3 Grid/EPS Connection	21
4.4 Battery Connection	22
4.5 PV Connection (N/A for AC Couple Inverter)	24
4.6 Meter/CT Connection	25
4.7 Communication Connection	27
<b>System Operation</b>	<b>38</b>
5.1 Inverter Working Mode	38
5.2 Startup/Shutdown the System	46
<b>Commissioning</b>	<b>47</b>
6.1 Inspection	47

6.2 Commissioning Procedure	47
<b>User Interface</b>	<b>48</b>
7.1 LED	48
7.2 App Setting Guide	52
<b>Maintenance</b>	<b>67</b>
8.1 Routine Maintenance	67
8.2 Inverter Troubleshooting	68
8.3 Removing the Inverter	78

**Please read this manual before using the product.**

*This user manual introduces the inverter in terms of its installation, electrical connections, operation, commissioning, maintenance, and troubleshooting. Please read through the manual carefully before installing and using the inverter, and keep the manual well for future reference.*

### Preface

#### About This Manual





This manual describes the installation, connection, the use of APP, commissioning and maintenance etc. of ESS inverter. Please first read the manual and related documents carefully before using the product and store it in a place where installation, operation and maintenance personnel can access it at any time. The illustration in this user manual is for reference only. This user manual is subject to change without prior notice.

#### Target Group

ESS inverters must be installed by professional electrical engineers who have obtained relevant qualifications.

## Symbol Conventions

The following safety instructions and general information are used within this user manual.

Symbol	Description
 DANGER	Indicates an imminently hazardous situation which, if not correctly followed, will result in serious injury or death.
 WARNING	Indicates a potentially hazardous situation which, if not correctly followed, could result in serious injury or death.
 CAUTION	Indicates a potentially hazardous situation which, if not correctly followed, could result in moderate or minor injury.
 NOTICE	Indicates a potentially hazardous situation which, if not correctly followed, could result in equipment failure, or property damage.
 NOTE	Calls attention to important information, best practices and tips: supplement additional safety instructions for your better use of the PV inverter to reduce the waste of your resource.









## 1 Safety

Before using the inverter, please read all instructions and cautionary markings on the unit and manual.

Put the instructions where you can take them easily.

The ESS inverter of ours strictly conforms to related safety rules in design and test. Local safety regulations shall be followed during installation, operation and maintenance. Incorrect operation work may cause injury or death to the operator or a third party and damage to the inverter and other properties belonging to the operator or a third party.

## 1.1 Symbols Used

Symbol	Description
	Danger of high voltage and electric shock! Only qualified personnel may perform work on the inverter.
	Danger of high voltage. Residual voltage in the inverter need 5 mins to discharge, wait 5 mins before operation.
	Danger of hot surface
	Fire danger
	Environmental Protection Use Period
	Refer to the operating instructions
	Product should not be disposed as household waste
	Grounding terminal

## 1.2 Safety Precaution

- Installation, maintenance and connection of inverters must be performed by qualified personnel, in compliance with local electrical standards, wiring rules and requirements of local power authorities and/or companies
- To avoid electric shock, DC input and AC output of the inverter must be terminated at least 5 minutes before performing any installation or maintenance.
- The temperature of some parts of the inverter may exceed 60°

during operation. To avoid being burnt, do not touch the inverter during before touching it.

- Ensure children are kept away from inverters.
- Don't open the front cover of the inverter. A part from performing work at the wiring terminal (as instructed in this manual), touching or changing components without authorization may cause injury to people, damage to inverters and annulment of the warranty
- Static electricity may damage electronic components. Appropriate method must be adopted to prevent such damage to the inverter; otherwise the inverter may be damaged and the warranty annulled.
- Ensure the output voltage of the proposed PV array is lower than the maximum rated input voltage of the inverter; otherwise the inverter may be damaged and the warranty annulled.
- When exposed to sunlight, the PV array generates dangerous high DC voltage. Please operate according to our instructions, or it will result in danger to life.
- PV modules should have an IEC61730 class A rating.
- If the equipment is used in a manner not specified by the manufacturer, the protection provided by the equipment may be impaired.
- Completely isolate the inverter before maintaining. Completely isolate the inverter should: Switch off the PV switch, disconnect the PV terminal, disconnect the battery terminal, and disconnect the AC terminal.
- Prohibit to insert or pull the AC and DC terminals when the inverter is running.
- Don't connect ESS inverter in the following ways:
- EPS Port should not be connected to grid;
- The single PV panel string should not be connected to two or more inverters.

## 2 Product Introduction

### 2.1 Overview

#### Hybrid Inverter

The hybrid inverters are high-quality inverter which can convert solar energy to AC energy and store energy into battery.

The inverter can be used to optimize self consumption, store in the battery for future use or feed into public grid. Work mode depends on PV energy and user's preference. It can provide power for emergency use during the grid lost by using the energy from battery and inverter (generated from PV).

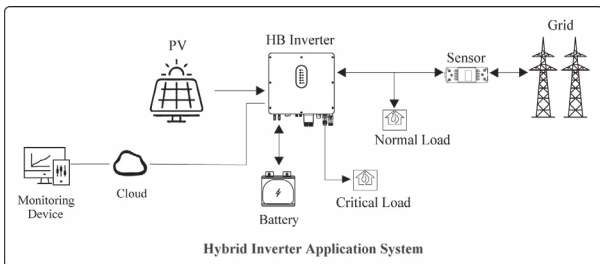



## AC Couple Inverter

The AC couple inverters are high-quality inverter which can store energy into battery.

The inverter can be used to optimize self consumption, store in the battery for future use or feed into public grid. Work mode depends on the battery and user's preference. It can provide power for emergency use during the grid lost by using the energy from battery.

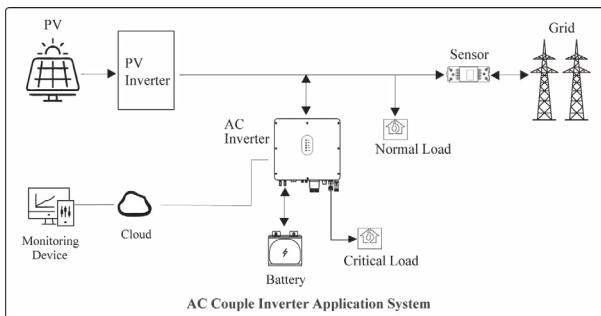

## 2.2 Product Appearance

### 2.2.1 Hybrid Inverter

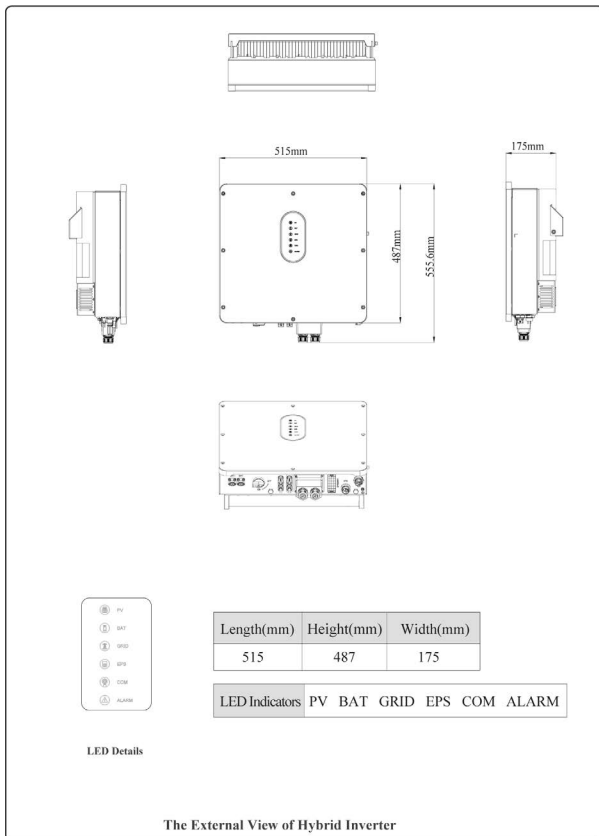

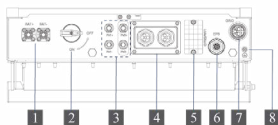

The bottom view of hybrid inverter

1. Battery Connect Terminals
2. PV Switch
3. PV Input Terminals
4. COM1 Ports  
(USB, PARAL, RS485, DRM, CT/METER, BMS, NTC/RMO/DRY)
5. COM2 Port  
(GPRS/WiFi/LAN)
6. EPS Output Terminal
7. GRID Output Terminal
8. Grounding Terminal

## 2.2.2 AC Couple Inverter

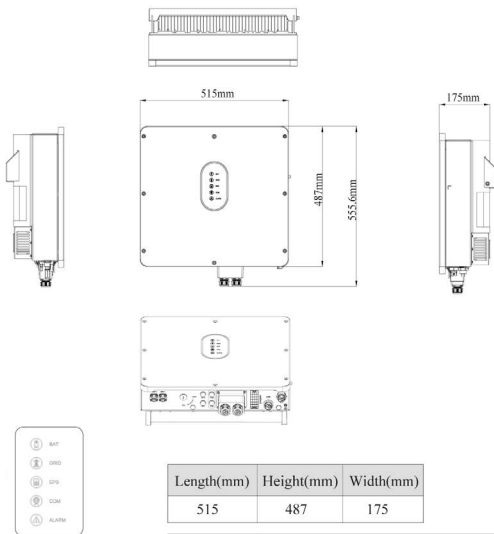

The External View of AC Couple Inverter

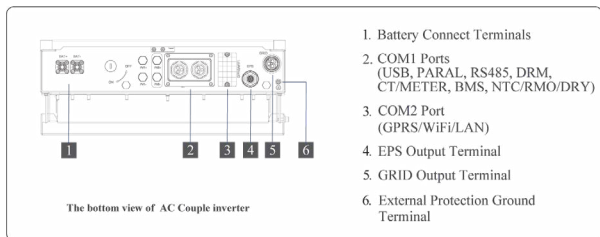

## NOTE!

The appearances of hybrid inverter and AC couple inverter are presented in detail in this section. The following chapters are only illustrated by hybrid inverter.

### 2.3 Model Definition

The letters in the product model have the specific informations.  
(Take SIH12005L052ACCU0B - Ascet 5K-120/1P2T2 as example.)

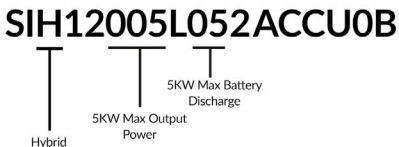

## 3 Installation

### 3.1 Packing List

After unpacking, please check the following packing list carefully for any damage or missing parts. If any damage or missing parts occurs, contact the supplier for help.

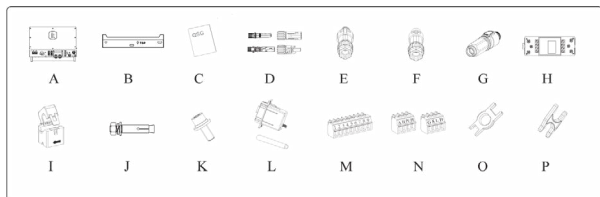

Number	Quantity	Description
A	1	Inverter
B	1	Mounting bracket
C	1	File package
D	2/2	PV terminal connector group (PV+/PV-); N/A for AC Couple
E	1	EPS connector
F	1	Grid connector
G	2	Battery connector
H	1	Meter (Optional)
I	1	CT
J	3	M12 Expansion screws
K	1	M6 Security screw
L	1	GPRS/WiFi module (Optional)
M	1	9-Pins terminal
N	2	4-Pins terminal
O	1	Removal tool for PV connector
P	1	Removal tool for Grid/EPS connector

## 3.2 Selecting the Mounting Location

### 3.2.1 Installation Environment Requirements

- The storage inverter protection class is IP65 and can be mounted indoors or outdoors.
- The mounting location must be inaccessible to unrelated personnel since the enclosure and heat sinks are extremely hot during operation.
- Do not install the storage inverter in areas containing highly flammable materials or gases.
- To ensure optimum operation and long service life, the ambient temperature must be below 50°C.
- The storage inverter must be mounted in a well ventilated environment to ensure good heat dissipation.
- To ensure long service life, the storage inverter must not be exposed to direct solar irradiation, rain, or snow. It is recommended that the inverter be mounted in a sheltered place.
- The carrier where the inverter is mounted must be fire-proof. Do not mount the inverter on flammable building materials.
- Do not install the inverter in a rest area since it will cause noise during operation.
- The installation height should be reasonable and make sure it is easy to operate and view the display.
- Product label and warning symbols shall be clear to read after installation.
- Please avoid direct sunlight, rain exposure, snow lay up install.

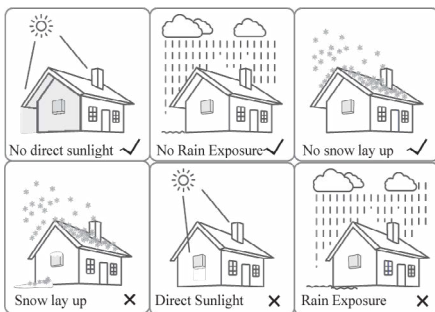

### 3.2.2 Mounting Requirements

Mount the inverter vertically or tilted backward by max 15°. The device can not be installed with a wrong mode and the connection area must point downward.

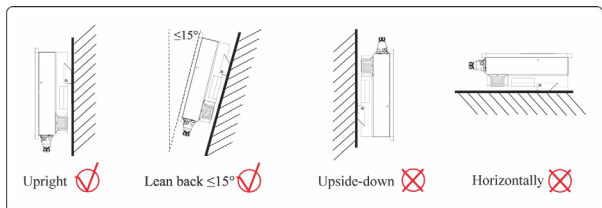

### 3.2.3 Installation Space Requirements

To ensure the inverter normally and easy to operate, there are requirements on available spaces of the inverter, e.g. to keep enough clearance. Refer to the following figures.

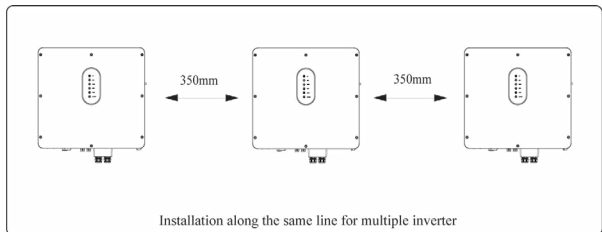
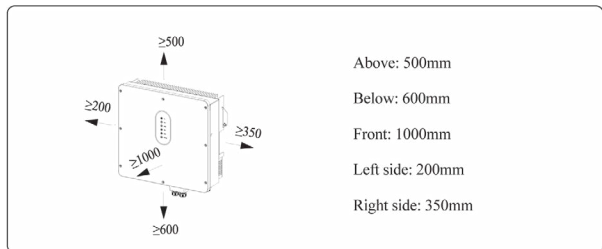



### 3.3 Mounting

Before mounting the inverter, you have to prepare expansion bolts (specification: M12\*80; Quantity: 3).

#### Step 1. Install the mounting bracket

1. Use a level ruler to mark the position of the 3 holes on the wall. Refer to Figure a. and drill 3 holes, 16mm in diameter and 55mm in deep. Refer to Figure b.

2. Knock the expansion screw kit into the hole together with a hammer. Refer to Figure c.

Note: Do not remove the nut unit in Figure c.

3. After tightening 2-3 buckles, the expansion bolts are tight and not loose, and then unscrew the bolts, spring washer, gasket. Refer to Figure c.

4. Install and fix the mounting bracket on the wall. Refer to Figure d.

#### Step 2. Install the inverter on the mounting bracket. Then lock the inverter using the security screw. Refer to Figure d.

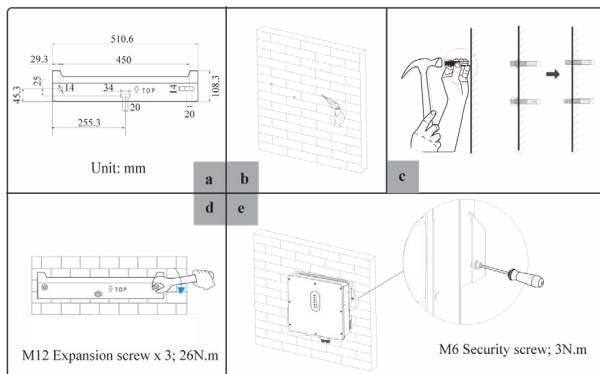



### **Danger**

Before drilling the hole on the wall, ensure no damage on the electric wire and/or water pipe inside the wall.



### **CAUTION**

To prevent potential damages and injuries from inverter falling down, please hang the inverter on the bracket, do not loosen grip unless confirm the inverter is well mounted.

## **4 Electrical Connection**

### **4.1 Inverter's setup connection**

This chapter shows the details connection of ESS inverter. The following illustration only uses the hybrid inverters as an example.

ESS inverter system connection diagram:

## Non-parallel connection mode

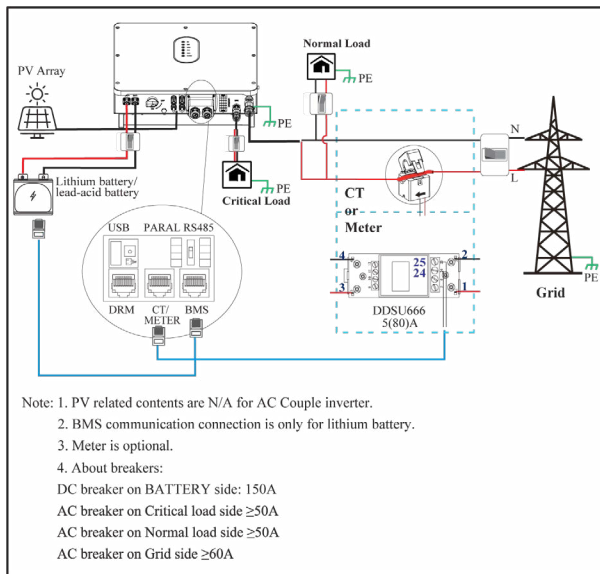

### DANGER

Ensure that inverter and all cables to be installed are completely powered off during whole installation and connection. Otherwise, fatal injury can occur due to the high voltage caused from AC and DC cables.

## Single phase parallel connection mode-Scheme A ( $N \leq 5$ )

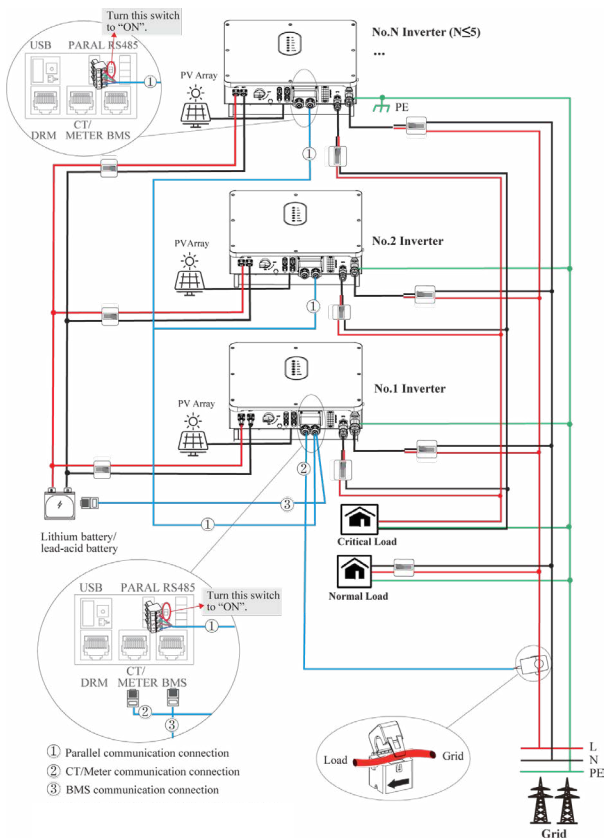

### Note for Scheme A:

1. PV related contents are N/A for AC Couple inverter.
2. BMS communication connection is only for lithium battery.
3. It is necessary to turn the matched resistance switch of No. 1 inverter and No. N inverter to "ON" in parallel connection mode.
4. With parallel connection mode, it is necessary to connect APP to one of inverters and then go to Console > Other Setting page to enable Parallel mode on APP. Please refer to page 65.
5. About breakers:  
DC breaker on BATTERY side: 150A  
AC breaker on Critical load side  $\geq 50A$   
AC breaker on Normal load side  $\geq 50A$   
AC breaker on Grid side  $\geq 60A$



#### **DANGER**

Ensure that inverter and all cables to be installed are completely powered off during whole installation and connection. Otherwise, fatal injury can occur due to the high voltage caused from AC and DC cables.

## Single phase parallel connection mode-Scheme B (N>5)

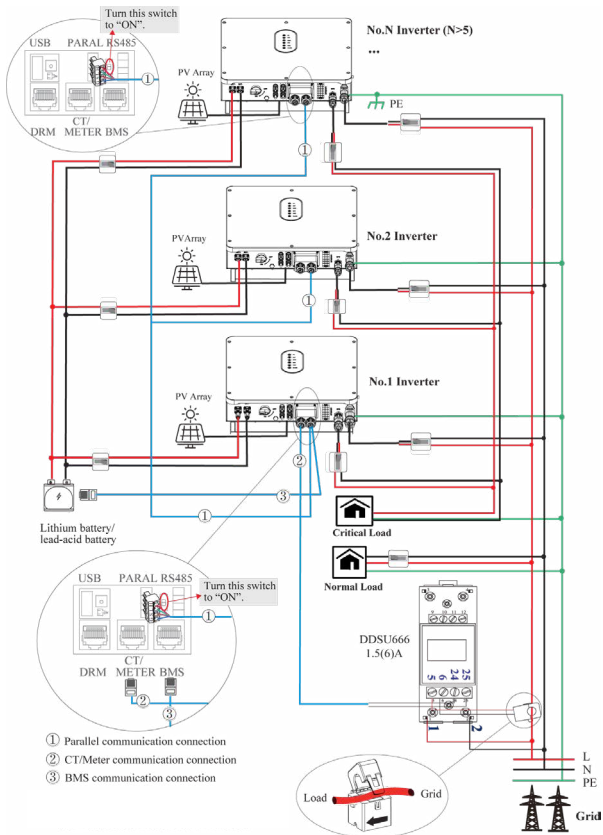

### Note for Scheme B:

1. PV related contents are N/A for AC Couple inverter.
2. BMS communication connection is only for lithium battery.
3. It is necessary to additionally purchase suitable CT and meter according to the specific requirements in parallel connection mode-Scheme B.
4. It is necessary to turn the matched resistance switch of No. 1 inverter and No. N inverter to "ON" in parallel connection mode.
5. With parallel connection mode, it is necessary to connect APP to one of inverters and then go to Console > Other Setting page to enable Parallel mode on APP. Please refer to page 65.
6. About breakers:  
DC breaker on BATTERY side: 150A  
AC breaker on Critical load side  $\geq 50A$   
AC breaker on Normal load side  $\geq 50A$   
AC breaker on Grid side  $\geq 60A$



### DANGER

Ensure that inverter and all cables to be installed are completely powered off during whole installation and connection. Otherwise, fatal injury can occur due to the high voltage caused from AC and DC cables.

### 4.2 Grounding

A protective earth (PE) terminal is equipped at the side of the inverter. Please be sure to connect this PE terminal to the PE bar for reliable grounding. AWG 10 or 12 yellow green lines are recommended.

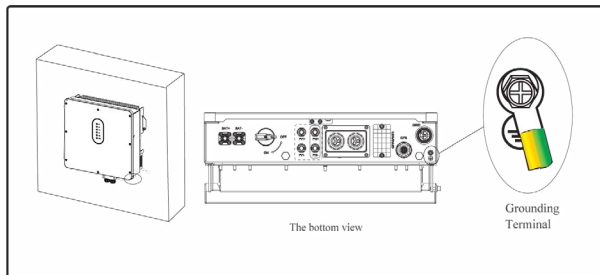

**⚠ DANGER**

The inverter must be grounded; otherwise, there may be electric shock risk.

**⚠ CAUTION**

If the positive pole or negative pole of the PV array is required to be grounded, then the inverter output (to ACgrid) must be isolated by transformer in accordance with IEC62109-1, -2 standards.

### 4.3 Grid/EPs Connection

Before connecting the GRID/EPs terminal, ensure that both the AC terminal and the DC terminal are powered OFF and the PV switch is OFF. Otherwise there is a risk of high voltage shock. Grid/EPs connection please refer to below.

**Step 1: Assemble the AC connector.**

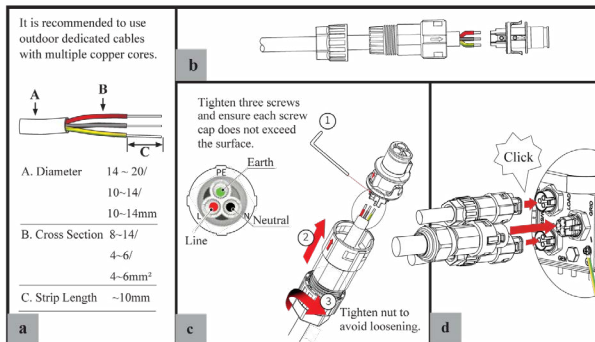
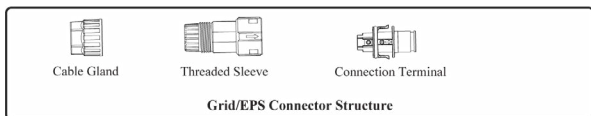



## Step 2: Connect the AC connector.

An AC breaker should be installed between inverter and the grid/EPS.

- Before connecting the AC cable from inverter to AC breaker, you should confirm the AC breaker is working normally. Turn off the AC breaker and keep it open.
- Connect the PE conductor to grounding electrode, and connect the N and L conductors to AC breaker.
- Connect the AC breakers to the grid/EPS grid.



### NOTICE

- Multiple inverters are not allowed to share a circuit breaker.
- Load is not allowed to connect between the inverter and the AC breaker.

To ensure that the inverter can be safely and reliably disconnected from the grid, a AC breaker( $\geq 50A$ ) should be installed only for inverter grid/ EPS port.

## 4.4 Battery Connection

ESS inverter now only supports the lithium / lead-acid battery.

This part in this manual only describe the battery connection on inverter side. If you need more detailed connection information about the battery side, please refer to the manual of the battery you using.

Before connecting to battery, please install a separate DC breaker (150A; not equipped) between inverter and battery. This ensure the inverter can be security disconnected during maintenance.

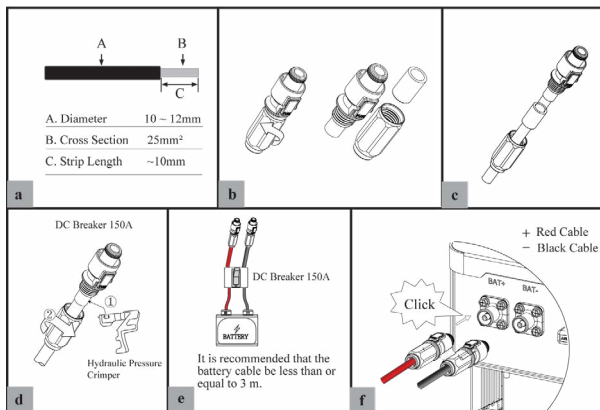

**⚠ WARNING**

- Polarity reverse will damage the inverter!
- Be careful of electric shock and chemical hazards!
- To reduce risk of injury, please use the suitable recommended cable size.

### Battery Communication Connection

If the battery type is lithium battery which need communication between the inverter and battery management system(BMS), the connection must be installed.

Please refer to section 4.7.1 for details.

#### 4.5 PV Connection (N/A for AC Couple Inverter)

PV connection please refer to below.

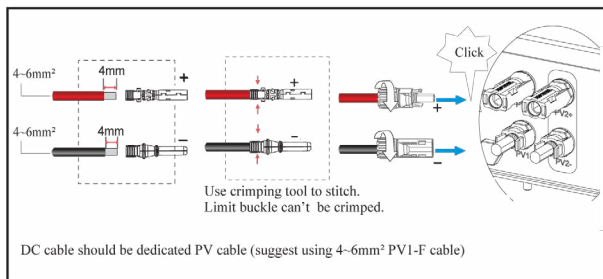

#### **WARNING**

- Before connection the PV panels, make sure the plug connector have the correct polarity. Incorrect polarity could permanently damage the inverter.
- PV array shouldn't be connected to the grounding conductor.
- The minimum insulation resistance to ground of the PV panels must exceed 18.33k $\Omega$ , there is a risk of shock hazard if the requirement of minimum resistance is not met.

## 4.6 Meter/CT Connection

You can monitor usage with a meter or a CT.

### 4.6.1 Meter Connection

This section is applicable to non-parallel connection mode only. ESS inverter only supports the meter: CHNT-DDSU666 meter. The meter is optional.

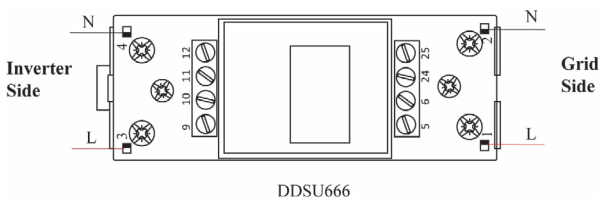

Before connecting to Grid, please install a separate AC breaker ( $\geq 60A$ ; not equipped) between meter and Grid. This ensure the inverter can be security disconnected during maintenance.

The connection diagram of power cable of meter is as shown in the figure below:

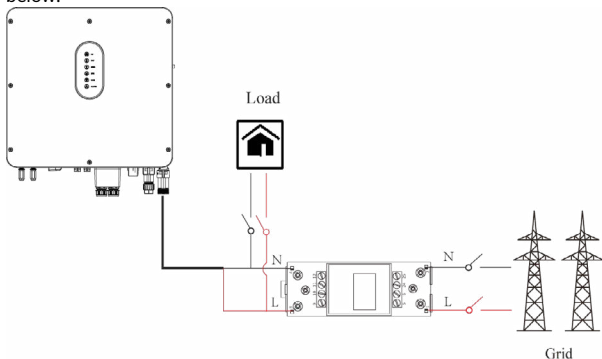

Please refer to the meter instruction manual for details.

#### 4.6.2 CT Connection

Before connecting to Grid, please install a separate AC breaker ( $\geq 60\text{A}$ ; not equipped) between CT and Grid. This ensure the inverter can be security disconnected during maintenance.

The connection diagram of power cable of CT is as shown in the figure below:

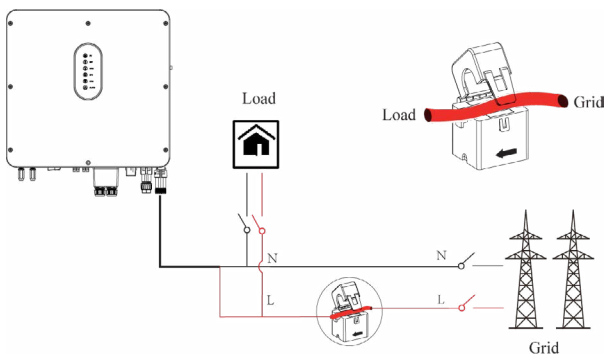

Please attention to the Current interchanger (CT) connection. The arrow on the CT indicates the current flow from grid to inverter. And lead the live line through the detection hole of CT.

#### NOTE!

*The current direction from grid to inverter is defined as positive and current direction from inverter to grid is defined as negative.*

## 4.7 Communication Connection

There are communication interfaces in the communication port on the bottom of the inverter as show below:

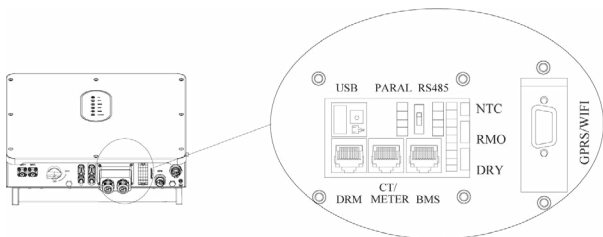

Interface	Descriptions	
USB	For fast firmware upgrade.	
PARAL	4-Pins interface for parallel communication	
	A matched resistance switch for parallel communication	
RS485	4-Pins interface for RS485 communication	
DRM	Demand response mode	
CT/METER	For Meter communication or Grid current sense.	
BMS	Lithium battery communication interface	
9-Pins	NTC	Temperature sensor terminal of lead-acid battery
	RMO	Remote off control
	DRY	DO control
GPRS/WIFI	For GPRS/WIFI communication.	

## 4.7.1 BMS Connection (Only for Lithium Battery)

### RJ45 Terminal Configuration of Battery Communication (BMS)

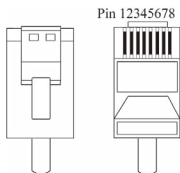

PIN	1	2	3	4
Function Description	RS485_A	RS485_B	GND_S	GND_S

PIN	5	6	7	8
Function Description	GND_S	GND_S	CAN_L	CAN_H

This manual describes the cable sequence of the inverter. For details about the cable sequence of the battery, see the manual of the battery you used.

Refer to the following steps:

**a** Unscrew the waterproof cover and loosen the rubber nut on waterproof cover.

**b** Make the RJ45 terminal according to above function description of each Pin definition. Lead the BMS cable through the rubber nut, seal and waterproof cover in turn.

- ① Insert RJ45 terminals into corresponding ports.
- ② Screw the waterproof cover back to inverter firmly with 4 x M4 screws(1.2N.m).
- ③ Install the seal into the threaded sleeve, fasten the rubber nut.

**c** Don't cut off any communication cables.

Press the BMS cable in the seal via the side incisions.

## 4.7.2 DRMs Connection

DRMs is a shortened form for “inverter demand response modes”.

### NOTE!

With DRMs connection, it is necessary to connect APP to inverter and then go to Console > Other Setting page to enable DRM function on APP. Please refer to page 65.

### RJ45 Terminal Configuration of DRMs

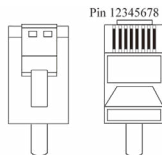

Refer to the following steps:

<b>PIN</b>	1	2	3	4
<b>Function Description</b>	DRM1/5	DRM2/6	DRM3/7	DRM4/8
<b>PIN</b>	5	6	7	8
<b>Function Description</b>	REF	DRM 0/COM	NC	NC

**a** Unscrew the waterproof cover and loosen the rubber nut on waterproof cover.

**c**

- ① Insert RJ45 terminals into corresponding ports.
- ② Screw the waterproof cover back to inverter firmly with 4 x M4 screws (1.2N.m).
- ③ Install the seal into the threaded sleeve, fasten the rubber nut.

**b** Make the RJ45 terminal according to above function description of each Pin definition. Lead the BMS cable through the rubber nut, seal and waterproof cover in turn.

Don't cut off any communication cables.

Press the DRMs cable in the seal via the side incisions.



### 4.7.3 Meter/CT Connection

#### RJ45 Terminal Configuration of Meter/CT Communication

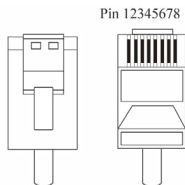

PIN	1	2	3	4	5	6	7	8
<b>Function Description</b>	RS485_A	RS485_B	RS485_A	RS485_B	CT-	CT+	NC	NC

#### 4.7.3.1 Meter Connection

##### Meter cable connection overview

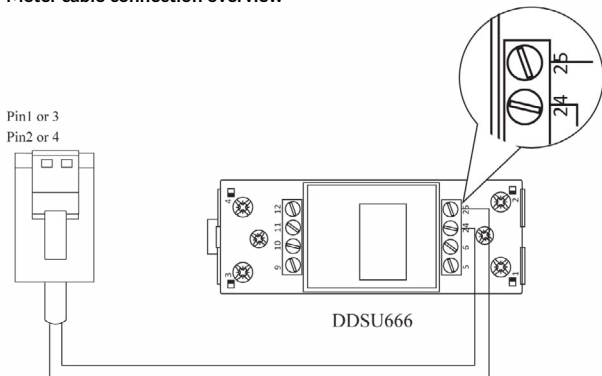

Inverter	Meter
Pin1 or Pin3(RS485_A)	Pin24
Pin2 or Pin4(RS485_B)	Pin25

Connect meter. Refer to the following steps:

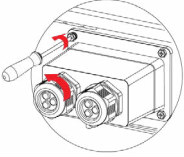

**a** Unscrew the waterproof cover and loosen the rubber nut on waterproof cover.

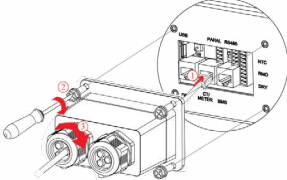

**c**

- ① Insert RJ45 terminals into corresponding ports.
- ② Screw the waterproof cover back to inverter firmly with 4 x M4 screws(1.2N.m).
- ③ Install the seal into the threaded sleeve, fasten the rubber nut.

**b** Make the RJ45 terminal according to above function description of each Pin definition. Lead the meter communication cable through the rubber nut, seal and waterproof cover in turn.

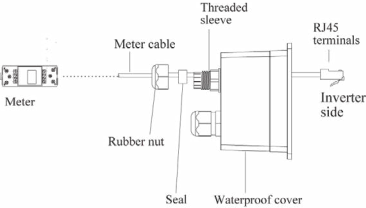



Don't cut off any communication cables.

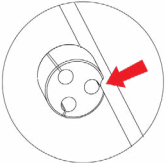

Press the meter cable in the seal via the side incisions.

### 4.7.3.2 CT Connection

This section is applicable to non-parallel connection mode and parallel connection-scheme A only

#### CT cable connection overview

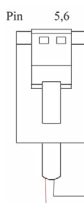

Inverter	CT
Pin5(CT-)	Black
Pin6(CT+)	Red

Connect CT. Refer to the following steps:

**a** Unscrew the waterproof cover and loosen the rubber nut on waterproof cover.

**c**

- ① Insert RJ45 terminals into corresponding ports.
- ② Screw the waterproof cover back to inverter firmly with 4 x M4 screws(1.2N.m).
- ③ Install the seal into the threaded sleeve, fasten the rubber nut.

**b** Make the RJ45 terminal according to above function description of each Pin definition. Lead the CT cable through the rubber nut, seal and waterproof cover in turn.

Don't cut off any communication cables.

Press the CT cable in the seal via the side incisions.

## 4.7.4 RS485 Connection

### 4-Pins Terminal Configuration of RS485 Communication



PIN	A	B	PE	PE
Function Description	RS485_A	RS485_B	PE	PE

Connect RS485. Refer to the following steps:

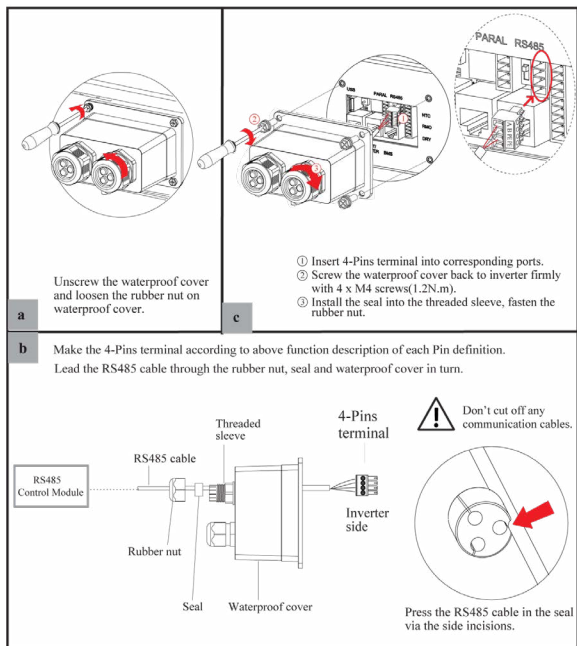

## 4.67.5 Parallel Communication Connection

### 4-Pins Terminal Configuration of parallel Communication



PIN	G	S	L	H
Function Description	GND_S	PARA_SYNC	CAN_L	CAN_H

### Parallel communication cable connection overview

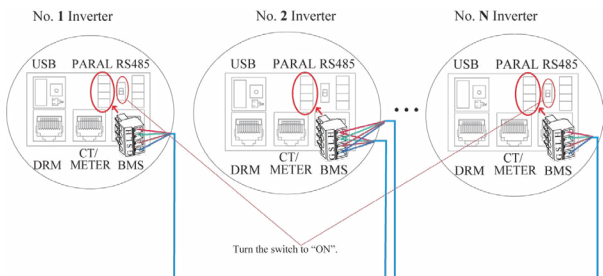

It is necessary to turn the matched resistance switch of No. 1 inverter and No. N inverter to “ON” in parallel connection mode.

Master Inverter	No. 1 Slave Inverter	No. N Slave Inverter
PinH(CAN_H)	PinH(CAN_H)	PinH(CAN_H)
PinL(CAN_L)	PinL(CAN_L)	PinL(CAN_L)
PinS(PARA_SYNC)	PinS(PARA_SYNC)	PinS(PARA_SYNC)
PinG(GND_S)	PinG(GND_S)	PinG(GND_S)

Refer to the following steps:

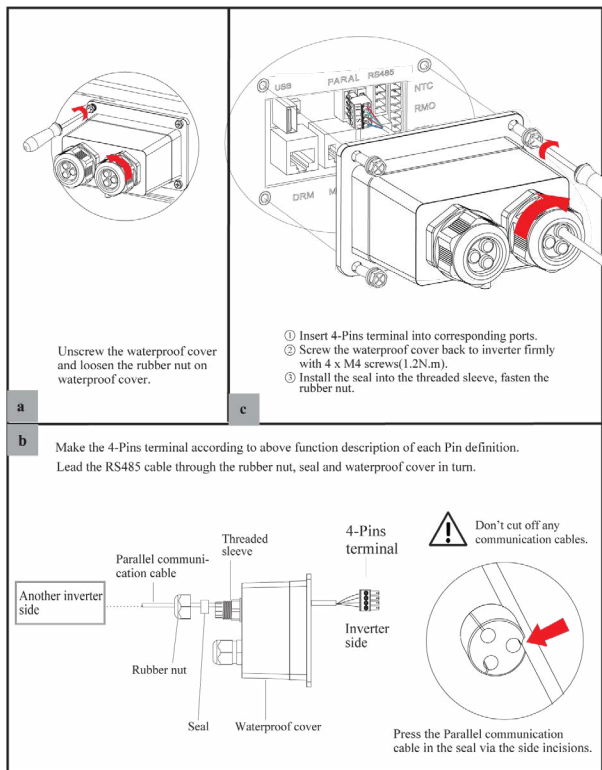

## 4.7.6 NTC/RMO/DRY Connection(s)

### 9-Pins Terminal Configuration of Auxiliary Communication

Pin123456789



PIN	Function Description
1	NO1 (Normal Open)
2	N1
3	NC1 (Normal Close)
4	NC2 (Normal Close)
5	N2
6	NC2 (Normal Close)
7	REMO OFF
8	GND S (NTC BAT)
9	NTC BAT+

Refer to the following steps:

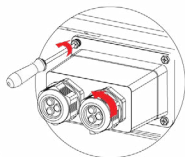

Unscrew the waterproof cover and loosen the rubber nut on waterproof cover.

a

b

Make the 9-Pins terminal according to above function description of each Pin definition for the auxiliary port you want to use.

Lead the NTC/RMO/DRY cable(s) through the rubber nut, seal and waterproof cover in turn.

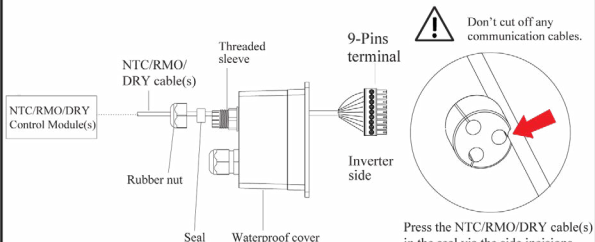

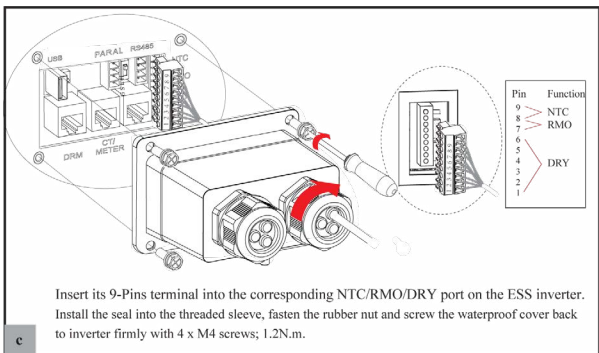

#### 4.6.7 GPRS/WiFi Module Connection (Optional)

GPRS/WiFi module connection please refer to below.

For details about APP settings, see the WIFI/GPRS Module Installation Guide in the packing case.

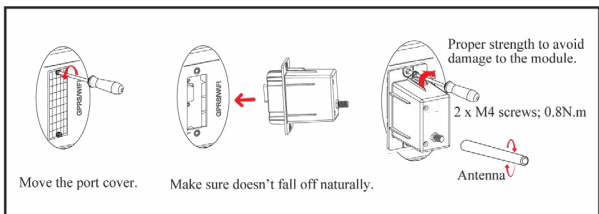



## 5 System Operation

### 5.1 Inverter Working Mode

The inverter supports several different working modes.

#### 5.1.1 Self Used Mode

Go to the “Hybrid work mode” menu, and select the “Self used mode” working mode. Under Self Used mode, the priority of PV energy will be Load > Battery > Grid, that means the energy produced by PV gives priority to local loads, excess energy is used for charging the battery, and the remaining energy is fed into the grid.

This is the default mode to increase self-consumption rate. There are several situations of Self used working mode based on PV energy.

##### a) Wealthy PV Energy

When PV energy is wealthy, the PV energy will first consumed by loads, the excess energy will be used to charge the battery then the remaining energy will be fed into the grid.

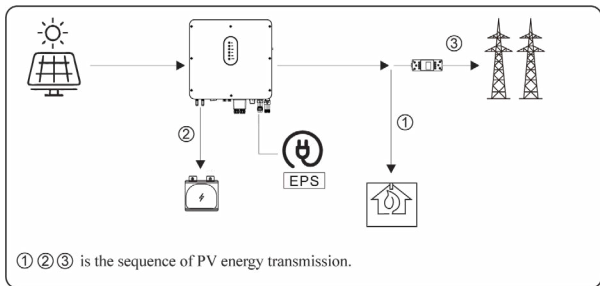

##### b) Limited PV power

When the PV energy is not enough to cover all the loads, all the PV energy will be used for load, and the insufficient part will be supported by battery. Then still insufficient parts will be supported by grid.

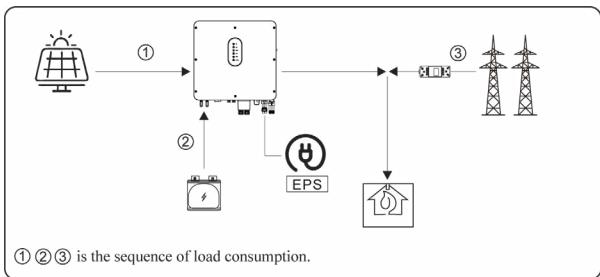

### c) No PV Input

The inverter will first discharge the battery energy for home load consuming when no PV input( such as in the evening or some cloudy or rainy days). If the demand is not met then will consume the grid energy.

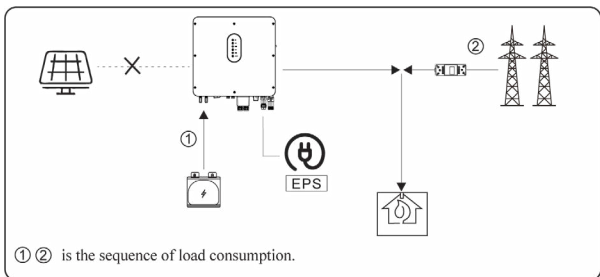

### 5.1.2 Feed-in Priority Mode

Go to the “Hybrid work mode” menu, and select the “Feed-in priority mode” working mode. Under this mode, the priority of PV energy will be Load > Grid > Battery, that means the energy produced by PV gives priority to local loads, excess energy is fed into the grid, and the remaining energy is used for charging the battery.

### a) Wealthy PV Energy

When PV energy is wealthy, the PV energy will be first consumed by loads, if there is excess PV power, then the excessive power will be fed into grid. If there is still PV energy rested after load consuming and grid feeding, then the rested PV power will be used to charge the battery.

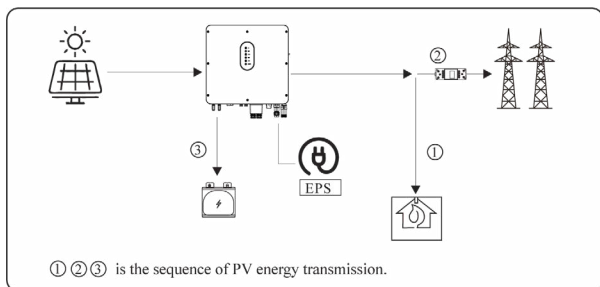

### b) Limited PV Energy

When PV energy is limited and can not meet the feed-in grid power, the battery will discharge to meet it.

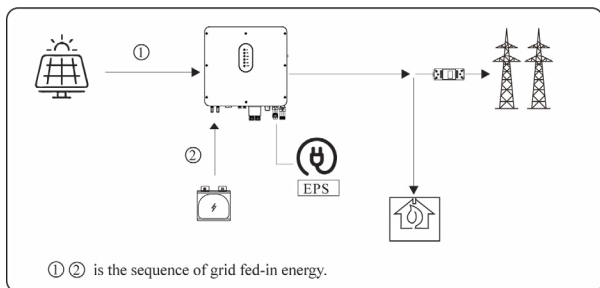

### c) No PV Input

The inverter will first discharge the battery energy for home load consuming when no PV input ( such as in the evening or some cloudy or rainy days). If the demand is not met then will consume the grid energy.

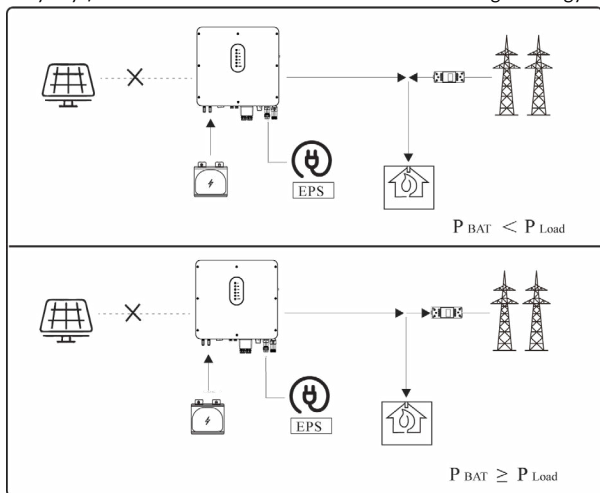

### 5.1.3 Time-Based Control Mode

Go to the “Hybrid work mode” menu, and select the “Time-based Control” working mode. Under this mode, you can control the charging and discharging of the inverter. You can set the following parameters based on your requirements:

- Charge and discharge frequency: one time or daily
- Charging start time: 0 to 24 hours
- Charging end time: 0 to 24 hours
- Discharge start time: 0 to 24 hours
- Discharge end time: 0 to 24 hours

You can also choose whether to allow the grid to charge the battery, which is prohibited by default. If the user enable the “Grid charge function”, the “Maximum grid charger power” and “Capacity of grid charger end” can be set. When the battery capacity reaches the set value of “Capacity of grid charger end”, the grid will stop charging the battery.

### 5.1.4 Back-up Mode

Go to the “Hybrid work mode” menu, and select the “Back-up Mode” working mode. Under this mode, the priority of PV energy will be Battery > Load > Grid.

This mode aims at charging the battery quickly, and at the same time, you can choose whether to allow AC to charge the battery.

#### Forbid AC charging

In this mode, the battery can be charged only with PV power, and the charging power varies with PV power.

##### a) Wealthy PV power

When PV energy is wealthy, PV charges the battery first, then meets the load, and the rest is fed into the grid.

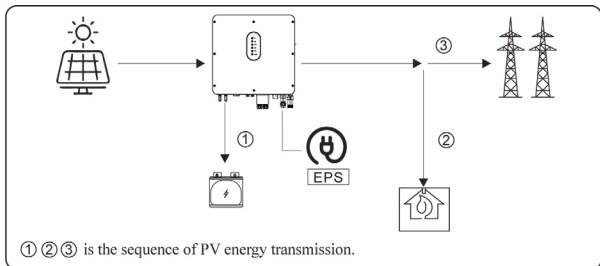

##### b) Limited PV power

When PV energy is limited, PV gives priority to charging the battery, and the grid directly meet the load demand.

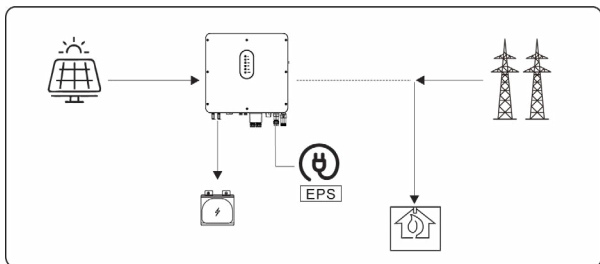

### Allow AC charging

In this situation, the battery can be charged both with PV and AC.

#### a) Wealthy PV power

When PV energy is wealthy, PV charges the battery first, then meets the load, and the rest is fed into the grid.

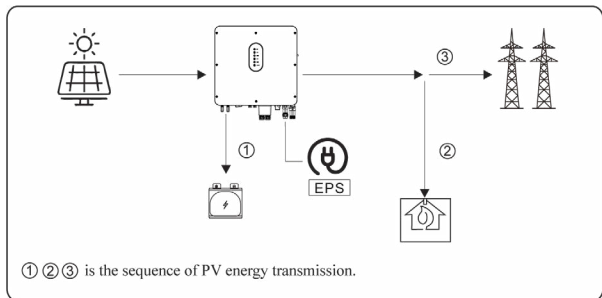

#### b) Limited PV power

When the PV energy is not enough to charge the battery, the grid energy will charge the battery as supplement. Meanwhile, the grid energy is consumed by loads.

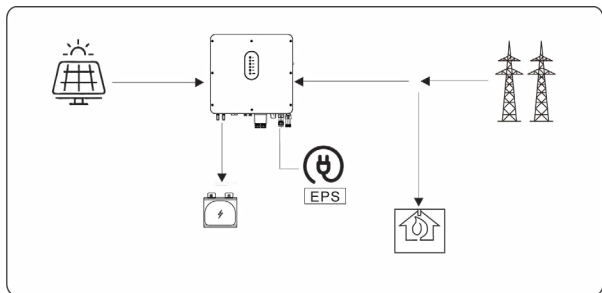

### 5.1.5 Off Grid Mode

When the power grid is cut off, the system automatically switches to Off Grid mode. Under off-grid mode, only critical loads are supplied to ensure that important loads continue to work without power failure.

Under this mode, the inverter can't work without the battery

#### a) Wealthy PV power

When PV energy is wealthy, the PV power will be first consumed by critical load, charging batteries and, conditioned, by the smart load (only if PV power is above 500W and the Battery SOC is more than 90%)

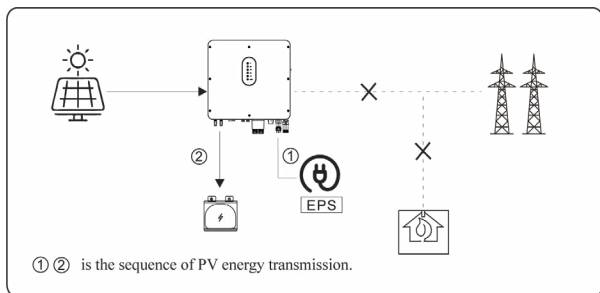

## b) Limited PV power

When PV energy is limited, EPS loads are first powered by PV and then supplemented by battery.

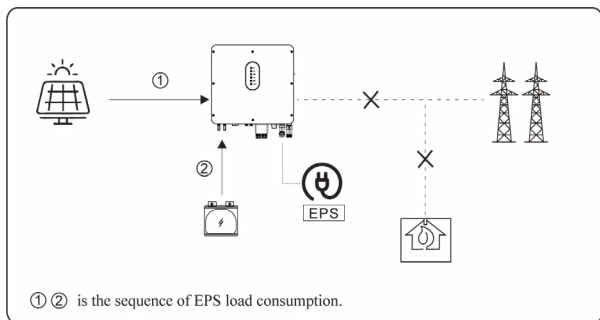

### NOTICE

- Under this mode, please complete the output voltage and frequency settings.
- It is better to choose the battery capacity larger than 100Ah to ensure EPS function work normally.
- If EPS output loads are inductive or capacitive loads, to make sure the stability and reliability of system, it is recommended to configure the power of these loads to be within 50% EPS output power range.



## 5.2 Startup/Shutdown the System

### 5.2.1 Startup the System

Check and confirm the installation is secure and strong enough and that the system grounding is OK. Then confirm the connections of AC, battery, PV etc. are correct. Confirm the parameters and configurations conform to relevant requirements.

AC Frequency 50/60Hz	PV Voltage 90~530V
Battery Voltage 42~60V	Grid AC Voltage 180~270V

Make sure all the above aspects are right, then follow the procedure to start up the inverter:

- 1) Power on the AC.
- 2) Power on the PV. ( N/A for AC Couple )
- 3) Power on the battery.
- 4) Connect the cell phone App via blue-tooth. Please refer to Section 7.2 for details.
- 5) Click the Power ON on the App for the first time. Please refer to Section 7.2 for details.

### 5.2.2 Shutdown the System

According to actual situation, if have to shut-down the running system, please follow below procedure:

- 1) Connect the cell phone App via blue-tooth. Please refer to Section 7.2 for details.
- 2) Click the Power Off on the App. Please refer to Section 7.2 for details.
- 3) Unpower off the battery.
- 4) Unpower off the PV. ( N/A for AC Couple )
- 5) Unpower off the AC.
- 6) If need to disconnect the inverter cables, please wait at least 5 minutes before touching these parts of inverter.

It is necessary to make a complete commissioning of the inverter system. This will essentially protect the system from fire, electric shock or other damages or injuries.

### 6.1 Inspection

Before commissioning, the operator or installer (qualified personnel) must inspect the system carefully and make sure:

- 1) The system is firmly installed correctly following the contents and notifications of this manual, and there are enough spaces for operation, maintenance and ventilation.
- 2) All the terminals and cables are in good status without any damages.
- 3) No items are left on the inverter or within the required clearance section.
- 4) The PV, battery pack is working normally, and grid is normal.

### 6.2 Commissioning Procedure

After the inspection and make sure status is right, then start the commissioning of the system.

- 1) Power on the system by referring to the Startup section 5.2.1.
- 2) Setting the parameters on the App according to user's requirement.
- 3) Finish commissioning.

## 7 User Interface

### 7.1 LED

This section describes the LED panel. LED indicator includes PV, BAT, GRID, EPS, COM, ALARM indicators. PV is N/A for AC couple. It includes the explanation of indicator states and summary of indicator states under the running state of the machine.

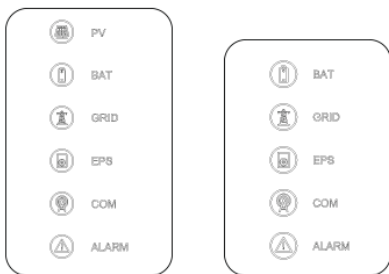

LED Indicator	Status	Description
PV	On	PV input is normal.
	Blink	PV input is abnormal.
	Off	PV is unavailable.
BAT	On	Battery is charging.
	Blink	Battery is discharging. Battery is abnormal.
	Off	Battery is unavailable.
GRID	On	GRID is available and normal.
	Blink	GRID is available and abnormal.
	Off	GRID is unavailable.
COM	On	Communication is ok.
	Off	Power supply is unavailable.
EPS	On	EPS power is available.
	Blink	EPS output is abnormal.
	Off	EPS power is unavailable.
ALARM	On	Fault has occurred and inverter shuts down.
	Blink	Alarms has occurred but inverter doesn't shut down.
	Off	No fault.

Details	Code	PV LED	Grid LED	BAT LED	EPS LED	COM LED	ALARM LED
PV normal		●	⊙	⊙	⊙	⊙	○
No PV		○	⊙	⊙	⊙	⊙	○
PV over voltage	B0						
PV under voltage	B4						
PV irradiation weak	B5	★	⊙	⊙	⊙	⊙	○
PV string reverse	B7						
PV string abnormal	B3						
On grid		⊙	●	⊙	⊙	⊙	○
Grid over voltage	A0						
Grid under voltage	A1						
Grid absent	A2						
Grid over frequency	A3	⊙	★	⊙	⊙	⊙	○
Grid under frequency	A4						
Grid abnormal	A6						
Grid over mean voltage	A7						
Neutral live wire reversed	A8						
Battery in charger		⊙	⊙	●	⊙	⊙	○
Battery absent	D1	⊙	⊙	○	⊙	⊙	○
Battery in discharge		⊙	⊙	★★	⊙	⊙	○
Battery under voltage	D3						
Battery over voltage	D2						
Battery discharge over current	D4	⊙	⊙	★	⊙	⊙	○
Battery over temperature	D5						
Battery under temperature	D6						
Communication loss (Inverter - BMS)	D8						
EPS output active		⊙	⊙	⊙	●	⊙	⊙
EPS output inactive		⊙	⊙	⊙	○	⊙	⊙
EPS short circuit	DB						
EPS over load	DC						
EPS output voltage abnormal	D7	⊙	⊙	⊙	★	⊙	○
EPS over dc-bias voltage	CP						

Details	Code	PV LED	Grid LED	BAT LED	EPS LED	COM LED	ALARM LED
RS485/DB9/BLE/USB		☉	☉	☉	☉	●	☉
Inverter over temperature	C5						
Fan abnormal	C8						
Inverter in power limit state	CL						
Data logger lost	CH	☉	☉	☉	☉	☉	★
Meter lost	CJ						
Remote off	CN						
PV insulation abnormal	B1						
Leakage current abnormal	B2						
Internal power supply abnormal	C0						
Inverter over dc-bias current	C2						
Inverter relay abnormal	C3						
GFCI abnormal	C6						
System type error	C7						
Unbalance Dc-link voltage	C9						
Dc-link over voltage	CA	☉	☉	☉	☉	☉	●
Internal communication error	CB						
Internal communication loss(E-M)	D9						
Internal communication loss(M-D)	DA						
Software incompatibility	CC						
Internal storage error	CD						
Boost abnormal	CG						
Dc-dc abnormal	CU						

Remark: ● Light on      ○ Light off      ☉ Keep original status

★ Blink 1s and off 1s

★★ Blink 2s and off 1s

## 7.2 App Setting Guide

### 7.2.1 Download App

- Scan the QR code on the inverter to download the APP.
- Download APP from the App Store or Google Play.

The APP should access some permissions such as device's location. You can allow them when you install the APP or grant permissions in your own phone setting.

### 7.2.2 App Architecture

It contains "Cloud Login" and "Local Connection".

- Cloud login: APP read data from cloud server through API and display inverter parameter
- Local connection: APP read data from inverter through Bluetooth connection with Modbus protocol to display and configure inverter parameter.

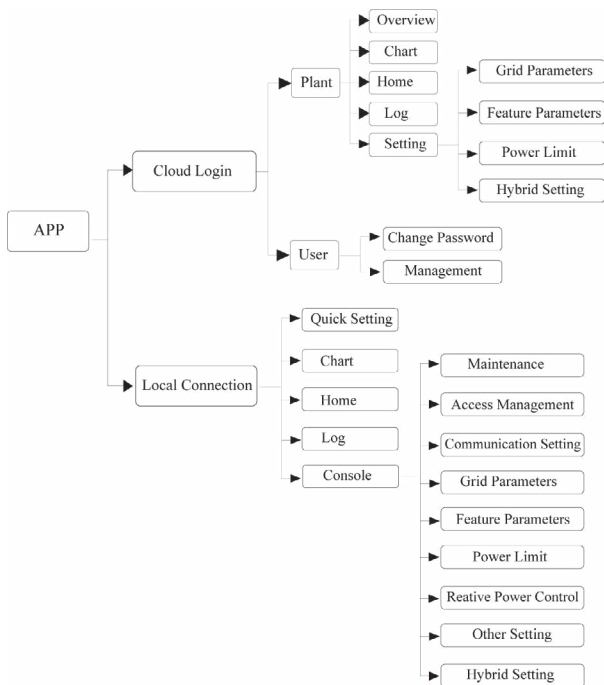

### 7.2.3 Local Setting

- Access Permission

Before using the local setting, the APP should access some permissions. ( You can allow them when you install the APP or grant permissions in your own phone setting. ) When the APP asks for permission, please click Allow.



- Connect Inverter

Firstly, open the Bluetooth on your own phone, then open the APP.

Press Local Setting to go to the connect page. This page shows the inverters which you can connect or you have connected. (As shown below

) Press the inverter's name to connect it.

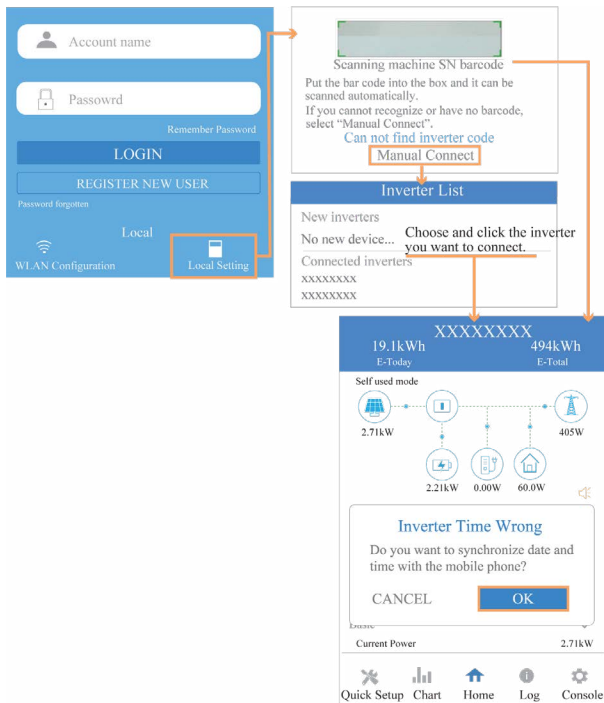

- Quick Setting

1. Connect to the router.

Step 1 Go to Quick Setting page.

Step 2 Click each item to enter the informations, then click

Next.

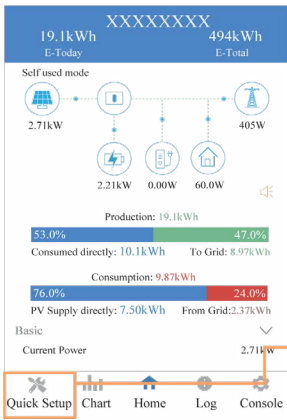

XXXXXXXXXX 1

1 2 3 4 5

Step1 Set parameters the inverter to connect to the router.

SSID  
Password

WiFi SSID      Click each item to enter the informations.  
WiFi PASSWORD

Next

2. Set parameters of power grid.

Step 1 Click each item to enter the parameters of power grid.

Step 2 Click Next.

Step 3 Click Previous back to the previous page.

XXXXXXXXXX 1

1 2 3 4 5

Step2 Set parameters for the inverter to connect to the power grid.

Standard Code  
Nominal Voltage(V)      Click to enter the informations.  
Nominal frequency (Hz)  
Date and Time

Previous      Next

Click here to back to previous setting item.

### 3. Set parameters of power limit

Step 1 Click each item to enter the parameters of power limit.

Step 2 Click Next.

Step 3 Click Previous back to the previous page.

Click each item to enter the informations

XXXXXXXX

1 2 3 4 5

Step3 Set parameters for the inverter to connect to the power limit.

Power control \_\_\_\_\_

Meter location \_\_\_\_\_

Meter Type \_\_\_\_\_

Power flow direction \_\_\_\_\_

Digital meter modbus address \_\_\_\_\_

Maximum feed in grid power(W) \_\_\_\_\_

Previous Next

### 4. Set parameters of work mode

Step 1 Click each item to enter the informations of work mode.

Step 2 Click Next.

Step 3 Click Previous back to the previous page.

XXXXXXXX 1

1 2 3 4 5

Step4 Set parameters for the inverter to connect to the workmode.

Hybrid work mode \_\_\_\_\_

Battery type selection \_\_\_\_\_

EPS Output

Click to enter the informations.

Previous Next

### 5. Start Inverter

Step 1 Click . 

Step 2 Click Previous back to the previous page.

XXXXXXXX 1

1 2 3 4 5

Step5 Please click the button below to start the inverter.

Click to start. 

Previous

- Chart

Under this menu, you can check the relevant data curve of energy (including Daily, Monthly and Annual).

### 1. Query(Daily) Data

Go to Chart > Day page. It will show the Daily Production or Consumption Curve in this page. You can swipe the screen left and right to switch the graph.

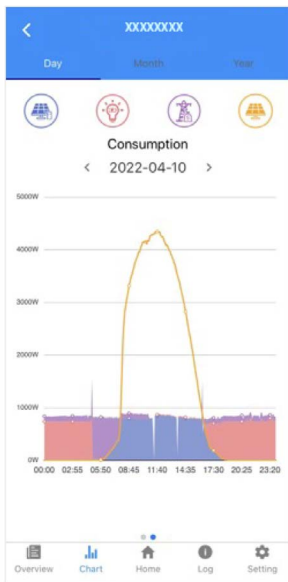
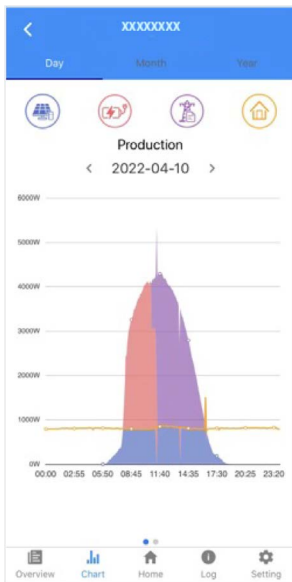

Different color curves represent energy data of different the icon. Click the icon to show and hide the corresponding curve of the corresponding content.

Click the curves to display the specific data.

You can also press the date such as "2022-03-24" in the figure to choose the day which you want to check. Or click the left and right arrows to switch the data of the day before yesterday and tomorrow (as shown in the Figure)

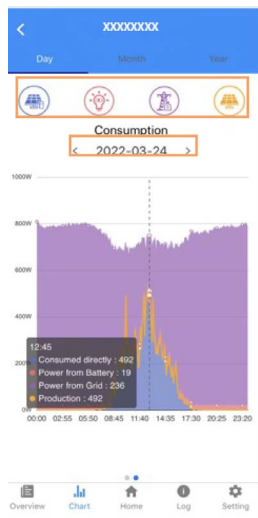

## 2. Query(Monthly or Yearly) Data

Go to Chart > Month or Year page. It will show the Daily Production or Consumption bars in this page. You can swipe the screen left and right to switch the graph. And the specific operation of checking data is the same as daily.

Daily data retention: 7 days

Monthly data retention: 36 months

yearly data retention: 10 years

- Local Setting Homepage

This page shows the basic information of inverter. Click  to display the warning message.

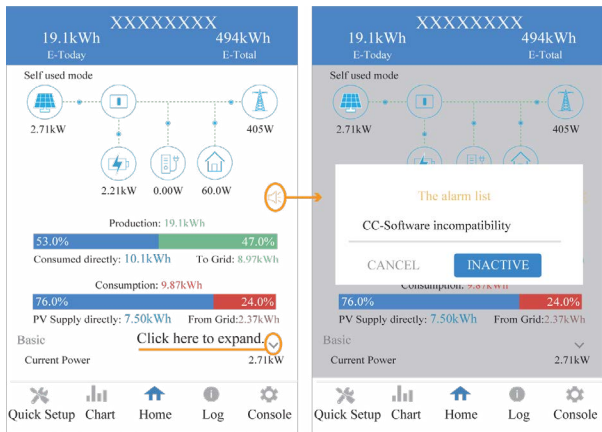

- History Log

Press Log at the bottom and then go to the history log page ( as shown below ). It contains all the logs for the inverter.

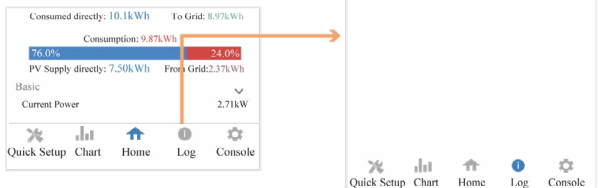

- Maintenance

Go to Console page. And click Maintenance

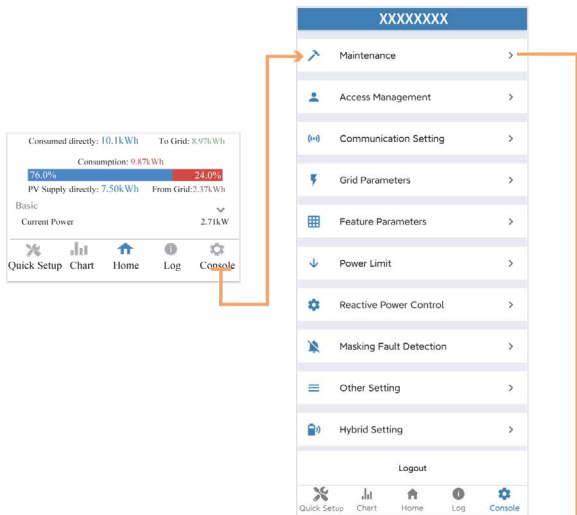

Then you need to enter password in a popup window (as shown below).

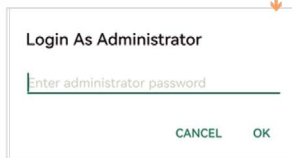

In this page, you can view the basic information like some version information, do some maintaining operations like turn off/on the inverter and manage data.

**< Maintenance**

Basic information

**Model Name**  
SE 5000HB-100

**Serial number**  
2135-89030333DH

**Master DSP Version**

**Slave DSP Version**

**CSB Version**  
010403

**DC-DC converter Version**

---

Maintaining

**Power On**  
Turn on the inverter

**Power Off**  
Turn off the inverter

**Factory data reset**  
Parameters will be reset to factory data

**Clear historical information**  
Clear historical information

---

Data Management

**History export**  
All device history will be exported to root directory

**Daily energy output**  
The energy data will be exported to root directory

**Monthly Energy Yield Export**  
The energy data will be exported to root directory

**Annual output**  
The energy data will be exported to root directory

About

**App Version**  
6.5.1



- Console

## Access Management

Go to Console > Access Management page. In this page, you can switch the login permission.

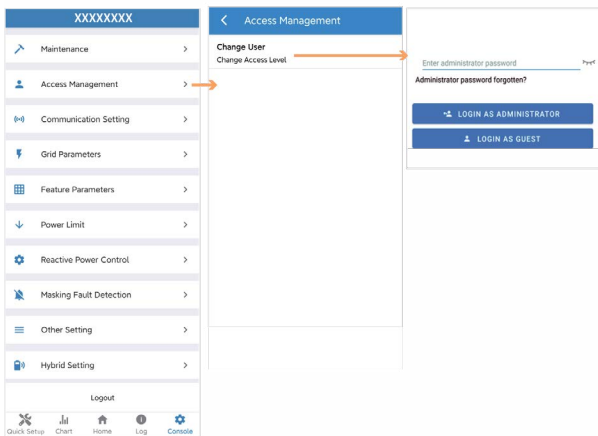

## Communication Setting

Go to Console > Communication Setting page. In this page, you can set or change the parameters of communication settings: Basic Setting, RS485 Setting and Ethernet Setting.

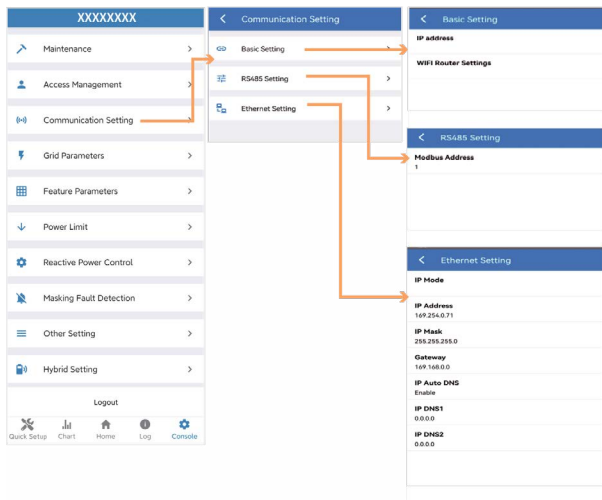

## Grid Parameters

Go to Console > Grid Parameters page. In this page, you can set or change the parameters of Grid side, as shown in the figure.

## Feature Parameters

Go to Console > Feature Parameters page. In this page, you can set or change the feature parameters, as shown in the figure.

## Power Limit

Go to Console > Power Limit page. In this page, you can set or change the parameters of power limit, as shown in the figure.

The figure shows a console menu on the right with orange arrows pointing to three configuration pages below. The menu items are: Maintenance, Access Management, Communication Setting, Grid Parameters, Feature Parameters, Power Limit, Reactive Power Control, Masking Fault Detection, Other Setting, and Hybrid Setting. The bottom of the menu includes Logout, Quick Setup, Chart, Home, Log, and Console.

Power Limit	Feature Parameters	Grid Parameters
<b>Power control</b> Digital Power Meter	Low Voltage Through <input type="checkbox"/>	<b>Standard Code</b> Unknown
<b>Meter location</b> On Grid	Island Detection <input type="checkbox"/>	<b>First Connect Delay Time(a)</b>
<b>Meter Type</b> CHINTDTSU666	Isolation Detection <input type="checkbox"/>	<b>Reconnect Delay Time (s)</b>
<b>Power flow direction</b> From grid to inverter	Leakage Current Detection(GFCI) <input type="checkbox"/>	<b>Frequency High Loss Level_1(Hz)</b> 0
<b>Digital meter modbus address</b> 200	Terminal Resistor <input type="checkbox"/>	<b>Frequency Low loss Level_1(Hz)</b> 0
<b>Maximum feed in grid power(W)</b> 70000	Derated Power(%) 0	<b>Voltage High Loss Level_1(V)</b> 0
	Power Factor 0.00	<b>Voltage Low Loss Level_1(V)</b> 0
	Insulation Impedance(kΩ)	<b>Frequency High Loss Time Level_1(ms)</b> 0
	Leakage Current Point(mA)	<b>Frequency Low loss Time Level_1(ms)</b> 0
	Unbalanced Voltage Point(%)	<b>Voltage High Loss Time Level_1(ms)</b> 0
	Moving Average Voltage Limit(V) 0	<b>Voltage Low Loss Time Level_1(ms)</b> 0
		<b>Frequency High Loss Level_2(Hz)</b> 0
		<b>Voltage High Loss Level_2(V)</b> 0
		<b>Frequency High Loss Time Level_2(ms)</b> 0
		<b>Voltage High Loss Time Level_2(ms)</b> 0

## Reactive Power Control

Go to Console > Reactive Power Control page. In this page, you can set or change the Reactive Power Control parameters.

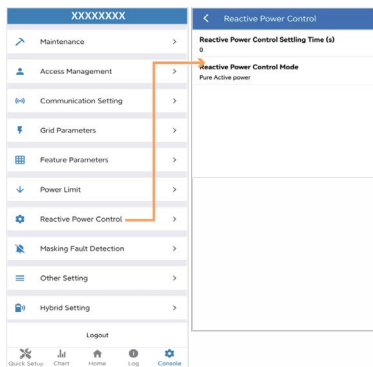

## Other Setting

Go to Console > Other Setting page. In this page, you can set other setting parameters.

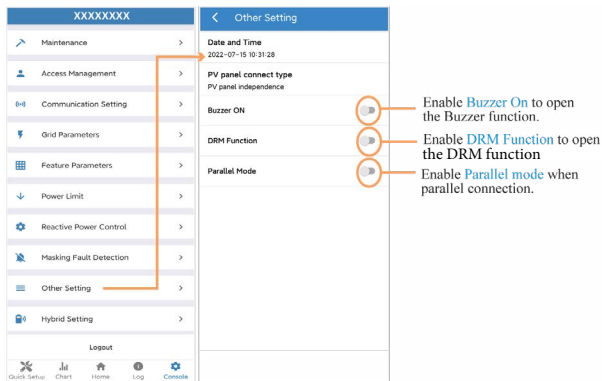

## Hybrid Setting

Go to Console > Hybrid Setting page. In this page, you can set Hybrid Setting parameters.

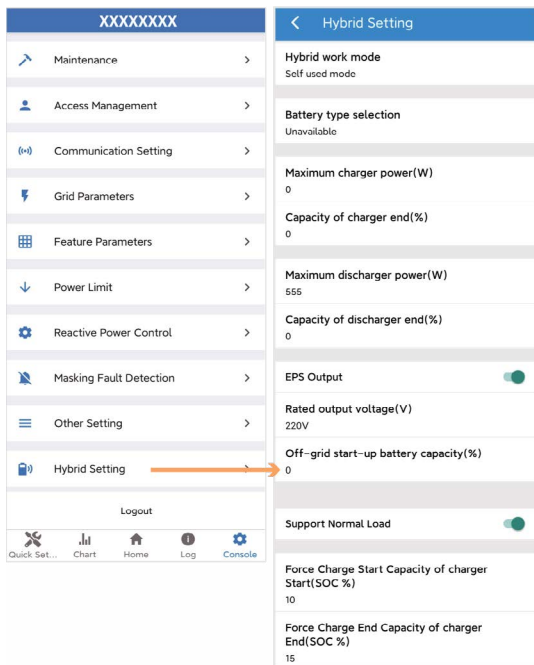

XXXXXXXX		< Hybrid Setting				
Maintenance	>	Hybrid work mode	Self used mode			
Access Management	>	Battery type selection	Unavailable			
Communication Setting	>	Maximum charger power(W)	0			
Grid Parameters	>	Capacity of charger end(%)	0			
Feature Parameters	>	Maximum discharger power(W)	555			
Power Limit	>	Capacity of discharger end(%)	0			
Reactive Power Control	>	EPS Output	<input checked="" type="checkbox"/>			
Masking Fault Detection	>	Rated output voltage(V)	220V			
Other Setting	>	Off-grid start-up battery capacity(%)	0			
Hybrid Setting	>	Support Normal Load	<input checked="" type="checkbox"/>			
Logout		Force Charge Start Capacity of charger Start(SOC %)	10			
Quick Set...	Chart	Home	Log	Console	Force Charge End Capacity of charger End(SOC %)	15

**CAUTION**

Before maintaining and commissioning inverter and its peripheral distribution unit, switch off all the charged terminals of the inverter and wait at least 10 minutes after the inverter is powered off.

### 8.1 Routine Maintenance

Items	Check Content	Maintain Content	Maintenance Interval
Inverter output status	Statistically maintain the status of electrical yield, and remotely monitor its abnormal status.	N/A	Weekly
PV inverter cleaning	Check periodically that the heat sink is free from dust and blockage.	Clean periodically the heat sink.	Yearly
PV inverter running status	Check that the inverter is not damaged or deformed. Check for normal sound emitted during inverter operation. Check and ensure that all inverter communications is running well.	If there is any abnormal phenomenon, replace the relevant parts.	Monthly
PV inverter electrical connections	Check that all AC, DC and communication cables are securely connected; Check that PGND cables are securely connected; Check that all cables are intact and free from aging.	If there is any abnormal phenomenon replace the cable or re-connect it.	Semiannually

## 8.2 Inverter Troubleshooting

When the inverter has an exception, its basic common warning and exception handling methods are shown below.

Code	Alarm Information	Suggestions
A0	Grid over voltage	<ol style="list-style-type: none"><li>1. If the alarm occurs occasionally, possibly the power grid voltage is abnormal for a short time, and no action is required.</li><li>2. If the alarm occurs repeatedly, contact the local power station. After receiving approval of the local power bureau, revise the electrical protection parameters settings on the inverter through the App.</li><li>3. If the alarm persists for along time, check whether the AC circuit breaker /AC terminals is disconnected or not, or if the grid has a power outage.</li></ol>
A1	Grid under voltage	
A3	Grid over frequency	
A4	Grid under frequency	
A2	Grid absent	Wait till power is restored.
B0	PV over voltage	Check whether the maximum voltage of a single string of input PV modules is greater than the allowable voltage. If the maximum voltage is higher than the standard voltage, modify the number of pv module connection strings.

B1	PV insulation abnormal	<p>1. Check the insulation resistance against the ground for the PV strings. If a short circuit has occurred, rectify the fault.</p> <p>2. If the insulation resistance against the ground is less than the default value in a rainy environment, set insulation resistance protection on the App.</p>
B2	Leakage current abnormal	<p>1. If the alarm occurs occasionally, the inverter can be automatically recovered to the normal operating status after the fault is rectified.</p> <p>2. If the alarm occurs repeatedly, contact your dealer for technical support.</p>
B4	PV under voltage	<p>1. If the alarm occurs occasionally, possibly the external circuits are abnormal accidentally. The inverter automatically recovers to the normal operating status after the fault is rectified.</p> <p>2. If the alarm occurs repeatedly or last a long time, check whether the insulation resistance against the ground of PV strings is too low.</p>
C0	Internal power supply abnormal	<p>1. If the alarm occurs occasionally, the inverter can be automatically restored, no action required.</p> <p>2. If the alarm occurs repeatedly, pls. contact the customer service center.</p>



C2	Inverter over dc-bias current	<ol style="list-style-type: none"> <li>1. If the alarm occurs occasionally, possibly the power grid voltage is abnormal for a short time, and no action is required.</li> <li>2. If the alarm occurs repeatedly, and the inverter fails to generate power, contact the customer service center.</li> </ol>
C3	Inverter relay abnormal	<ol style="list-style-type: none"> <li>1. If the alarm occurs occasionally, possibly the power grid voltage is abnormal for a short time, and no action is required.</li> <li>2. If the alarm occurs repeatedly, pls. refer to the suggestions or measures of Grid over voltage and the inverter fails to generate power, contact the customer service center. If there is no abnormality on the grid side, the machine fault can be determined. (If you open the cover and find traces of damage to the relay, it can be concluded that the machine is faulty.) And pls. contact the customer service center.</li> </ol>
CN	Remote of	<ol style="list-style-type: none"> <li>1. Local manual shutdown is performed in APP.</li> <li>2. The monitor executed the remote shutdown instruction.</li> <li>3. Remove the communication module and confirm whether the alarm disappears. If it does, replace the communication module. Otherwise, please contact the customer service center.</li> </ol>

C5	Inverter over temperature	<p>1. If the alarm occurs occasionally, the inverter can be automatically restored, no action required.</p> <p>2. If the alarm occurs repeatedly, pls. check the installation site for direct sunlight, good ventilation, and high ambient temperature (Such as installed on the parapet). If the ambient temperature is lower than 45 ° C and the heat dissipation is good, contact the customer service center.</p>
C6	GFCI abnormal	<p>1. If the alarm occurs occasionally, it could have been an occasional exception to the external wiring, the inverter can be automatically recovered, no action required.</p> <p>2. If it occurs repeatedly or cannot be recovered for a long time, pls. contact customer service to report repair.</p>
B7	PV string reverse	Check and modify the positive and negative polarity of the input of the circuit string.
C8	Fan abnormal	<p>1. If the alarm occurs occasionally, pls. restart the inverter.</p> <p>2. If it occurs repeatedly or cannot be recovered for a long time, check whether the external fan is blocked by foreign objects. Otherwise, contact customer service.</p>
C9	Unbalance Dc-link voltage	<p>1. If the alarm occurs occasionally, the inverter can be automatically recovered and no action is required.</p> <p>2. If the alarm occurs repeatedly, the inverter cannot work properly. Pls. contact the customer service center.</p>
CA	Dc-link over voltage	

CB	Internal communication error	<ol style="list-style-type: none"><li>1. If the alarm occurs occasionally, the inverter can be automatically recovered and no action is required.</li><li>2. If the alarm occurs repeatedly, the inverter cannot work properly. Pls. contact the customer service center</li></ol>
CC	Software incompatibility	<ol style="list-style-type: none"><li>1. If the alarm occurs occasionally, the inverter can be automatically recovered and no action is required.</li><li>2. If the alarm occurs repeatedly, the inverter cannot work properly. Pls. contact the customer service center.</li></ol>
CD	Internal storage error	<ol style="list-style-type: none"><li>1. If the alarm occurs occasionally, the inverter can be automatically recovered and no action is required.</li><li>2. If the alarm occurs repeatedly, the inverter cannot work properly. Pls. contact the customer service center.</li></ol>
CE	Data inconsistency	<ol style="list-style-type: none"><li>1. If the alarm occurs occasionally, the inverter can be automatically recovered and no action is required.</li><li>2. If the alarm occurs repeatedly, the inverter cannot work properly. Pls. contact the customer service center</li></ol>
CF	Inverter abnormal	<ol style="list-style-type: none"><li>1. If the alarm occurs occasionally, the inverter can be automatically recovered and no action is required.</li><li>2. If the alarm occurs repeatedly, the inverter cannot work properly. Pls. contact the customer service center.</li></ol>

CG	Boost abnormal	<ol style="list-style-type: none"> <li>1. If the alarm occurs occasionally, the inverter can be automatically recovered and no action is required.</li> <li>2. If the alarm occurs repeatedly, the inverter cannot work properly. Pls. contact the customer service center.</li> </ol>
CJ	Meter lost	<ol style="list-style-type: none"> <li>1. Check the meter parameter Settings</li> <li>2. Local APP checks that the communication address of the inverter is consistent with that of the electricity meter</li> <li>3. The communication line is connected incorrectly or in bad contact</li> <li>4. Electricity meter failure.</li> <li>5. Exclude the above, if the alarm continues to occur, please contact the customer service center.</li> </ol>
P1	Parallel ID warning	It is Parallel ID Alarm. Pls. check the parallel communication cable, and check whether any inverter joins or exits online. All inverters are powered off completely, check the line, and then power on the inverters again to ensure that the alarm is cleared.
P2	Parallel SYN signal warning	Parallel synchronization signal is abnormal. Check whether the parallel communication cable is properly connected.
P3	Parallel BAT abnormal	The parallel battery is abnormal. Whether the battery of the inverter is reported low voltage or the battery is not connected

P4	Parallel GRID abnormal	The parallel grid is abnormal. Whether the grid of the inverter is abnormal
D2	Battery over voltage	<ol style="list-style-type: none"> <li>1. If the alarm occurs occasionally, the inverter can be automatically recovered and no action is required.</li> <li>2. Check that the battery overvoltage protection value is improperly set.</li> <li>3. The battery is abnormal.</li> <li>4. If exclude the above, the alarm continues to occur, please contact the customer service center.</li> </ol>
D3	Battery under voltage	<ol style="list-style-type: none"> <li>1. If the alarm occurs occasionally, the inverter can be automatically recovered and no action is required.</li> <li>2. Check the communication line connection between BMS and inverter (lithium battery).</li> <li>3. The battery is empty or the battery voltage is lower than the SOC cutoff voltage.</li> <li>4. The battery undervoltage protection value is improperly set.</li> <li>5. The battery is abnormal.</li> <li>6. If exclude the above, the alarm continues to occur, please contact the customer service center.</li> </ol>
D4	Battery discharger over current	<ol style="list-style-type: none"> <li>1. Check whether the battery parameters are correctly set.</li> <li>2. Battery undervoltage.</li> <li>3. Check whether a separate battery is loaded and the discharge current exceeds the battery specifications.</li> <li>4. The battery is abnormal.</li> <li>5. If exclude the above, the alarm continues to occur, please contact the customer service center.</li> </ol>

D5	Battery over temperature	<ol style="list-style-type: none"> <li>1. If the alarm occurs repeatedly, please check whether the installation site is in direct sunlight and whether the ambient temperature is too high (such as in a closed room).</li> <li>2. If the battery is abnormal, replace it with a new one.</li> <li>3. If exclude the above, the alarm continues to occur, please contact the customer service center</li> </ol>
D6	Battery under temperature	<ol style="list-style-type: none"> <li>3. If exclude the above, the alarm continues to occur, please contact the customer service center</li> </ol>
D7	EPS output voltage abnormal	<ol style="list-style-type: none"> <li>1. Check whether the EPS voltage and frequency Settings are within the specified range.</li> <li>2. Check whether the EPS port is overloaded.</li> <li>3. When not connected to the power grid, check whether EPS output is normal.</li> <li>4. If exclude the above, the alarm continues to occur, please contact the customer service center.</li> </ol>
D8	Communication error (Inverter-BMS)	<ol style="list-style-type: none"> <li>1. Check whether the battery is disconnected.</li> <li>2. Check whether the battery is well connected with the inverter.</li> <li>3. Confirm that the battery is compatible with the inverter. It is recommended to use CAN communication.</li> <li>4. Check whether the communication cable or port between the battery and the inverter is faulty.</li> <li>5. If exclude the above, the alarm continues to occur, please contact the customer service center.</li> </ol>

D9	Internal communication loss(E-M)	<ol style="list-style-type: none"> <li>1. Check whether the communication cables between EPS, electricity meter and inverter are well connected and whether the wiring is correct.</li> <li>2. Check whether the communication distance is within the specification range</li> <li>3. Disconnect the external communication and restart the electricity meter and inverter.</li> <li>4. If exclude the above, the alarm continues to occur, please contact the customer service center.</li> </ol>
DA	Internal communication loss(M-D)	<ol style="list-style-type: none"> <li>1. If the alarm occurs occasionally, the inverter can be automatically recovered and no action is required.</li> <li>2. If the alarm occurs repeatedly, please check:               <ol style="list-style-type: none"> <li>1) Check whether the MC4 terminal on the PV side is securely connected.</li> <li>2) Check whether the voltage at the PV side is open circuit, ground to ground, etc.</li> </ol> <p>If exclude the above, the alarm continues to occur, please contact the customer service center</p> </li> </ol>
CU	Dcdc abnormal	<ol style="list-style-type: none"> <li>1. If the alarm occurs occasionally, the inverter can be automatically recovered and no action is required.</li> <li>2. If the alarm occurs repeatedly, the inverter cannot work properly. Pls. contact the customer service center</li> </ol>
CP	EPS over dc-bias voltage	<ol style="list-style-type: none"> <li>1. If the alarm occurs occasionally, the inverter can be automatically recovered and no action is required.</li> <li>2. If the alarm occurs repeatedly, the inverter cannot work properly. Pls. contact the customer service center</li> </ol>

DB	EPS short circuit	<p>. Check whether the live line and null line of EPS output are shortcircuited.</p> <p>2. If it is confirmed that the output is not short-circuited or an alarm, please contact customer service to report for repair. (After the troubleshooting of alarm problems, EPS switch needs to be manually turned on during normal use.)</p>
DC	EPS over load	<p>1. Disconnect the EPS load and check whether the alarm is cleared</p> <p>2. If the load is disconnected and the alarm is generated, please contact the customer service. (After the alarm is cleared, the EPS switch needs to be manually turned on for normal use.)</p>



### 8.3 Removing the Inverter

#### **WARNING**

Before removing DC input connector, double check DC input switch is turned to OFF to avoid inverter damage and personal injury

Perform the following procedures to remove the inverter:

Step 1. Disconnect all cables from the inverter, including communications cables, DC input power cables, AC output power cables, and PGND cable, as shown below.

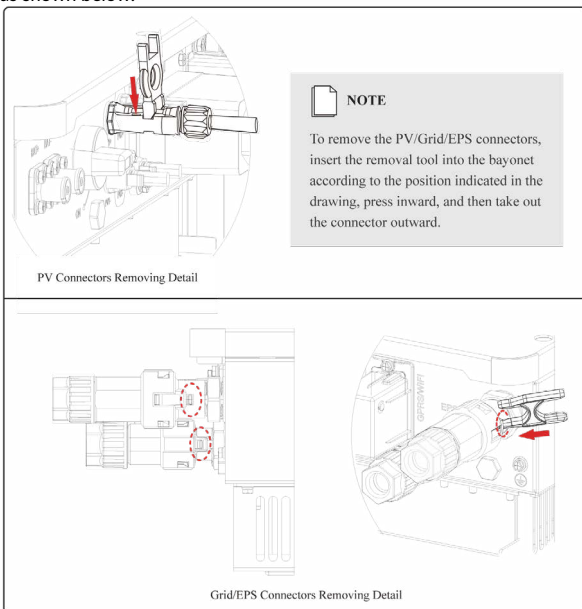

Step 2. Remove the inverter from the mounting bracket.

Step 3. Remove the mounting bracket.



## **Disposal of Old Electrical & Electronic Equipment**

*(Applicable in the European Union and other European countries with separate collection systems)*

This symbol on the product or on its packaging indicates that this product shall not be treated as household waste.

Instead it shall be handed over to the applicable collection point for the recycling of electrical and electronic equipment.

By ensuring this product is disposed of correctly, you will help prevent potential negative consequences for the environment and human health, which could otherwise be caused by inappropriate waste handling of this product.

The recycling of materials will help to conserve natural resources.

<b>Introducere</b>	<b>82</b>
<b>Masuri de siguranta</b>	<b>83</b>
Simboluri de siguranta	83
1.1 Simboluri utilizate	84
1.2 Precautii de siguranta	84
<b>Prezentare produs</b>	<b>86</b>
2.1 Notiuni generale	86
2.2 Descriere produs	88
2.3 Definitie model	90
<b>Instalarea</b>	<b>91</b>
3.1 Verificarea ambalajului	91
3.2 Selectarea locatiei de instalare	93
3.3 Instalarea	95
<b>Conexiunile electrice</b>	<b>96</b>
4.1 Schema de conectare a inverterului	96
4.2 Impamantarea	101
4.3 Conectarea la retea / EPS	102
4.4 Conectarea bateriilor	103
4.5 Conectarea panourilor PV	105
4.6 Conectarea CT/meter	106
4.7 Conexiune de comunicatie	108
<b>Operarea Sistemului</b>	<b>119</b>
5.1 Mod de functionare	119
5.2 Pornirea/Oprirea sistemului	127

<b>Punerea in functiune</b>	<b>128</b>
6.1 Inspectia	128
6.2 Procedura de punere in functiune	128
<b>Interfata utilizatorului</b>	<b>129</b>
7.1 LED	129
7.2 Ghid de setare aplicatie	133
<b>Mentenanata</b>	<b>148</b>
8.1 Mentenanata de rutina	148
8.2 Depanare inverter	149
8.3 Dezinstalarea inverterului	155

# Va rugam sa parcurgeti manualul inainte de a instala si opera inverterul.





*Acest manual prezinta inverterul din punct de vedere al montarii, instalarii si conectarii electrice, functionarii, punerii in functiune, mentenantei si a depanarii. Va rugam sa parcurgeti manualul inainte de a instala si opera inverterul si pastrati-l pentru viitoare referinte.*

### Pentru personal autorizat

Acest manual de utilizare este dedicat personalului autorizat in instalatii invertore hibride si pentru electricienii calificati.

## Simboluri de siguranta

Simbolurile utilizate in acest manual evidentiaza riscurile potentiale si informatiile care asigura siguranta operatorului, si sunt prezentate dupa cum urmeaza:









Symbol	Description
 PERICOL	Indica situatii periculoase iminente care incorect executate pot rezulta in raniri grave, chiar moartea
 AVERTISMENT	Indica situatii potential periculoase care incorect executate pot rezulta in raniri grave, chiar moartea
 ATENTIONARE	Indica situatii potential periculoase care incorect executate pot rezulta in raniri usoare si moderate.
 NOTIFICARE	Indica situatii potential periculoase care incorect executate pot rezulta in daune asupra echipamentului sau proprietatii.
 BINE DE STIUT	Atrage atentia asupra unor informatii importante, bune practici sau sfaturi: este o suplimentare a instructiunilor de siguranta si pentru o mai buna operare a echipamentului

### 1 Masuri de siguranta

Inainte de a opera produsul, va rugam sa cititi cu atentie masurile de precautie prezentate in acest manual. Pastrati manualul la indemana in caz de necesitate.

Invertorul este conform standardelor de proiectare si a testelor de siguranta in vigoare. In instalarea sa, aveti in vedere reglementarile electrice locale si urmati-le in fiecare etapa. Utilizarea incorecta poate duce la consecinte grave pentru operator sau tert, de la defectarea echipamentului si distrugerea proprietatii pana la raniri grave, chiar moartea.

## 1.1 Simboluri utilizate

Simbol	Descriere
	Pericol de electrocutare! Doar personalul autorizat are acces la aceasta unitate!
	Tensiuni inalte. Pericol! Tensiunea reziduala se mentine inca 5 minute dupa oprire. Nu executati lucrari decat dupa aceste 5 minute.
	Suprafata foarte fierbinte
	Pericol de foc
	Perioada de utilizare in siguranta
	Indica o referinta catre documentatia de operare
	Produsul nu trebuie aruncat impreuna cu gunoii menajer
	Terminal de impamantare

## 1.2 Precautiile de siguranta

- Invertorul trebuie instalat, conectat, operat si verificat doar de tehnicieni / electricieni specializati. Tehnicianul specializat trebuie sa cunoasca reglementarile si masurile de siguranta in ceea ce priveste reseaua electrica, functionarea invertorului ongrid si standardele electrice locale
- Pentru a evita pericolul de electrocutare, intrarea DC si iesirea AC trebuie inchise inainte cu 5 minute de orice fel de interventie tehnica, cum ar fi mentenanta.

- Temperatura anumitor parti din inverter poate ajunge la peste 60°C in timpul functionarii. Pentru a evita arsuri grave nu atingeti inverterul.
- Asigurati-va ca este restrictionat accesul copiilor la inverter.
- Nu deschideti carcasa inverterului. In afara interventiilor la terminale nu este permisa schimbarea componentelor interne fara autorizarea lucrarii. Aceste schimbari pot produce pagube, raniri si anulara garantiei.
- Incarcarea electrostatica poate dauna componentelor electronice. Luati masurile necesare pentru a evita aceste efecte. In caz contrar, inverterul se poate defecta si garantia se va anula.
- Asigurati-va ca tensiunea de la panourile fotovoltaice este mai mica decat maximul de tensiune sustinut de inverter, in caz contrar inverterul se va defecta, iar garantia se va anula
- Expuse la soare, panourile solare genereaza cantitati periculoase de curent continuu. Va rugam respectati instructiunile pentru a evita punerea in pericol a vietii operatorului sau tertilor.
- Panourile solare care vor fi conectate trebuie sa aibe ratingul IEC61730, clasa A.
- Daca echipamentul va fi folosit in alt mod decat cel mentionat de producator, protectiile echipamentului nu vor functiona.
- Izolati complet inverterul inainte de a executa mentenanta. Izolarea consta in: inchiderea intrerupatorului si deconectarea terminalului de la panouri, deconectati terminalul de la baterii si deconectati terminalul AC.
- Este interzisa conectarea sau deconectarea terminalelor AC and DC atunci cand inverterul functioneaza
- Respectati conectarile inverterului de tip ESS in urmatorul mod: Nu conectati portul EPS la grid.
- Un sir de panouri solare nu ar trebui conectate la doua sau mai multe invertoare.



## 2 Prezentare produs

### 2.1 Notiuni generale

#### Invertorul hibrid

Invertoarele solare hibride convertesc radiatia solara in energie alternativa, avand totodata posibilitatea de a stoca energie in baterii.

Invertorul poate fi folosit pentru a genera energie electrica pentru consumul propriu, stocarea sa in baterii sau injectarea in rețeaua publica de electricitate. Modulile de functionare depind de energia fotovoltaica disponibila si preferinta de consum a utilizatorului. Poate sustine alimentarea cu energie electrica a consumatorilor in timpul penelor de curent folosindu-se atat de energia stocata in baterii cat si de cea captata de panourile solare.

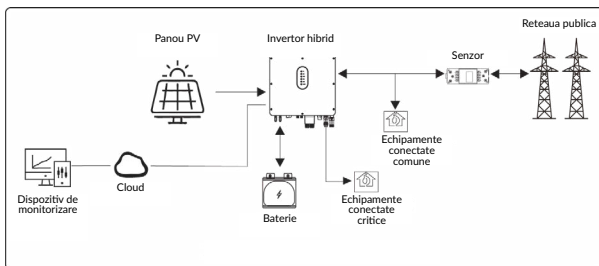

## Sistem de invertoare cuplate AC

Aceste sisteme de invertoare vor stoca energia in baterii daca cererea de consum este mai mica decat productia de panourile fotovoltaice. Invertorul poate fi folosit pentru a genera energie electrica pentru consumul propriu, stocarea in baterii sau injectarea in rețeaua publica de electricitate. Modurile de functionare depind de energia fotovoltaica disponibila si preferinta de consum a utilizatorului. Poate sustine alimentarea cu energie electrica in timpul penelor de curent prin energia stocata de baterii.

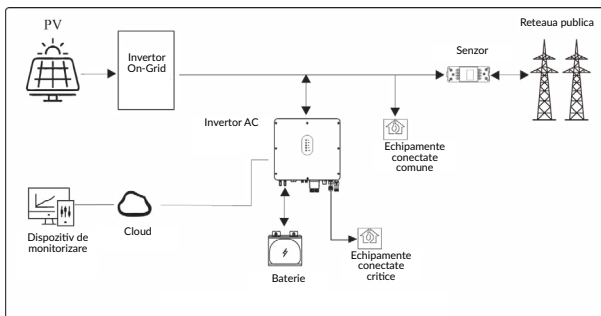

## 2.2 Descriere produs

### 2.2.1 Invertorul hibrid

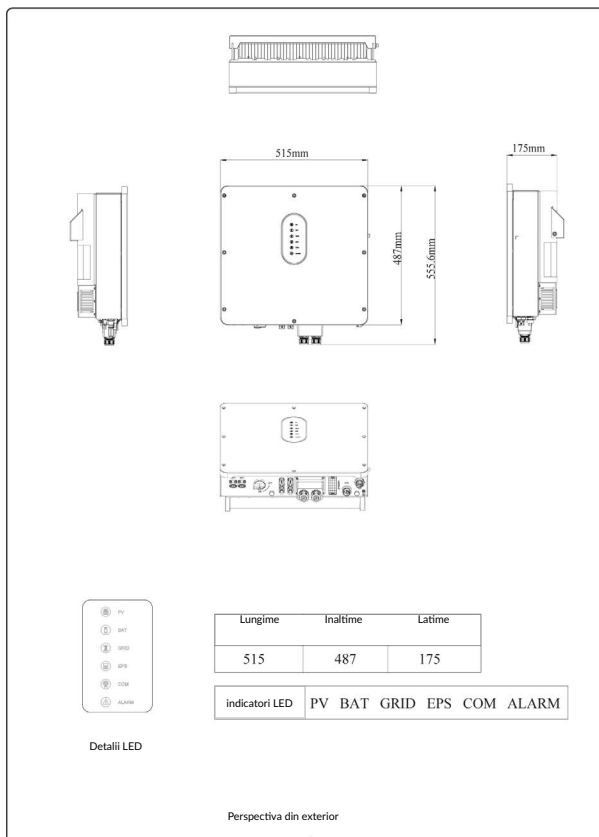

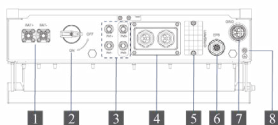

Perspectiva de jos a invertorului

1. Terminale de conectare baterii
2. Intrerupator fotovoltaic
3. Terminale de conectare panouri fotovoltaice
4. Grup porturi de comunicare 1 (USB, PARAL, RS485, DRM, CT/METER, BMS, NTC/RMO/DRY)
5. Grup porturi de comunicare 2 (GPRS/WiFi/LAN)
6. Terminal iesire EPS
7. Terminal de iesire retea / grid
8. Terminal de impamantare

## 2.2.2 Sistem de inverter cuplat AC

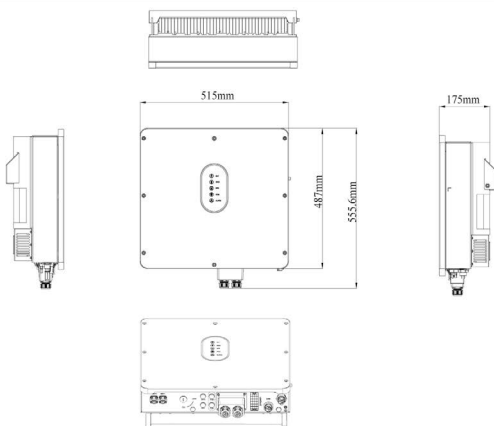

Detalii LED

Lungime	Inaltime	Latime
515	487	175

Indicatori LED	BAT GRID EPS COM ALARM
----------------	------------------------

Perspectiva din exterior

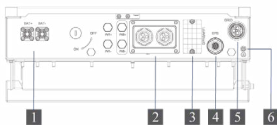

Perspectiva de jos a invertorului

1. Terminale de conectare baterii
2. Grup porturi de comunicare 1 (USB, PARAL, RS485, DRM, CT/METER, BMS, NTC/RMO/DRY)
3. Grup porturi de comunicare 2 (GPRS/ WiFi/LAN)
4. Terminal iesire EPS
5. Terminal de iesire retea / grid
6. Terminal de impamantare

## NOTA!

Descrierea ambelor invertoare este facuta in acest capitol. Mai departe se vor ilustra exemple doar cu tipul de invertor hibrid.

### 2.3 Definire model

Fiecare litera de identificare din numele produsului are o semnificatie specifica (De exemplu: SIH12005L05XACCU0B - Ascet 5K-120/1P2T2)

# SIH12005L052ACCU0B

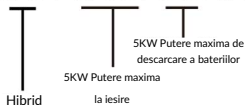

## 3 Instalarea

### 3.1 Verificarea ambalajului

La primirea inverterului, verificati ca ambalajul sa fie intact. Dupa inlaturarea ambalajului, verificati ca toate componentele sa fie in intacte si complete, in concordanta cu lista de livrabile din comanda.

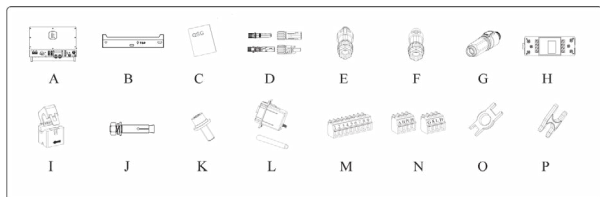

Notatie litera	Cantitate	Descriere livrabil
A	1	Invertor
B	1	Brachetii de montare
C	1	Manual de utilizare
D	2/2	Group de conectori terminale PV (PV+/PV-) Indisponibil in cazul Invertoarelor AC
E	1	Conector EPS
F	1	Conector retea
G	2	Conector baterie
H	1	Power meter (optional)
I	1	CT
J	3	Suruburi de ancorare M12
K	1	Surub M6
L	1	Modul GPRS/WiFi (optional)
M	1	Terminal cu 9 pini
N	2	Terminal cu 4 pini
O	1	Unealta de indepartare conector PV
P	1	Unealta de indepartare conector EPS/GRID

## 3.2 Selectarea locatiei de instalare

### 3.2.1 Cerinte pentru mediu de instalare

- a. Invertorul are certificarea IP65 si poate fi montat in interior sau exterior
- b. Nu instalati invertorul intr-un loc usor accesibil de personal neautorizat care poate veni in contact cu oricare parte a carcasei sau radiator si pot suferi arsuri sau electrocutari.
- c. Nu instalati invertorul in zone cu risc de incendiu sau materiale inflamabile
- d. Temperatura ambientala trebuie mentinuta sub 50°C pentru o functionare corecta si o durata de viata mai mare.
- e. Invertorul trebuie instalat intr-un spatiu foarte bine ventilat pentru a asigura disiparea eficienta a caldurii.
- f. Invertorul nu trebuie expus direct la razele soarelui, ploaie, ninsoare pentru a-i extinde perioada de viata. Este recomandat sa fie instalat in interior. Daca nu este posibila instalarea in interior este recomandata achizitionarea unei copertine sau acoperis.
- g. Adapostul unde se va efectua instalarea invertorului trebuie sa fie rezistent la foc. Nu instalati invertorul aproape de materiale inflamabile
- h. Nu instalati invertorul pe pereti falsi, placi de gips-carton sau pereti slab izolati fonic pentru a evita zgomotele puternice produse in timpul functionarii.
- i. Inaltimea la care se instaleaza invertorul trebuie sa fie rezonabila pentru a se executa usor lucrari de mentenanta sau observa display-ul.
- j. Etichetele cu avertismentele de siguranta trebuie sa fie usor de citit si dupa instalare.
- k. Evitati instalarea in bataia directa a soarelui, ploii sau zapezii.

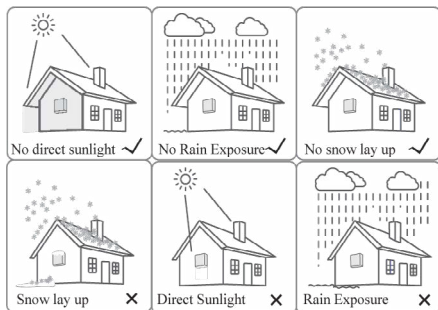



### 3.2.2 Cerinte pentru pozitia de instalare

Instalarea invertorului se face in pozitie verticala la un unghi de inclinare maxim de 15 grade pentru o disipare a caldurii eficienta. Zona de conexiuni electrice trebuie orientata in jos. Exemple de instalare corecta si gresita in schita urmatoare

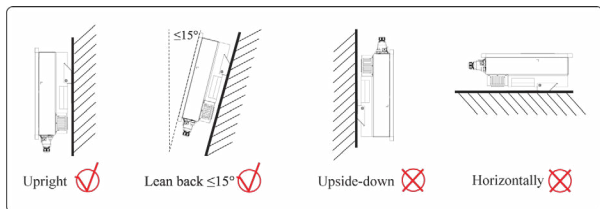

### 3.2.3 Cerinte pentru spatiu de instalare

Pentru a va asigura ca invertorul este simplu de operat, sunt necesare respectarea cerintelor pentru pastrarea unui spatiu suficient la locul instalarii, cum prezinta figura de mai jos

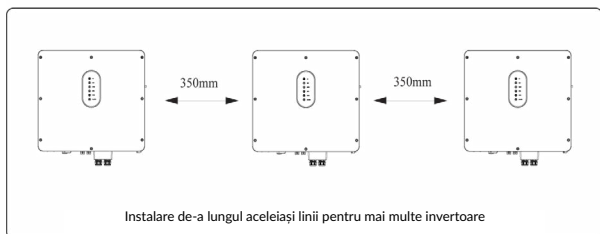
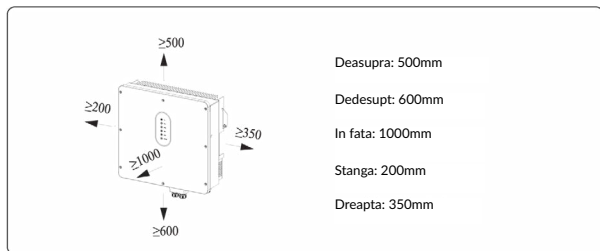

### 3.3 Instalarea

Înainte de a începe instalarea pregătiți suruburile de ancorare (spec: M12\*80, 3 buc).

#### Pasul 1. Ancorati brachetii de instalare

1. Pozitionati punctele de fixare corect cu ajutorul unui indicator de nivel și marcați-le utilizând un marker, apoi găuriți cele 3 puncte, 16mm diametru și 55mm adâncime

2. Inserați suruburile de ancorare complete cu ajutorul unui ciocan, observați figura c.

Nota: Nu scoateți piulita surubului de fixare

3. După ce suruburile sunt fixe în perete, desurubați piulita, saiba cu arc, și garnitura, observați figura c.

4. Pozitionați și fixați brachetii pe perete, ca în figura d.

**Pasul 2. Pozitionați invertorul pe brachetul deja instalat și fixați-l utilizând suruburile de securizare, ca în figura d.**

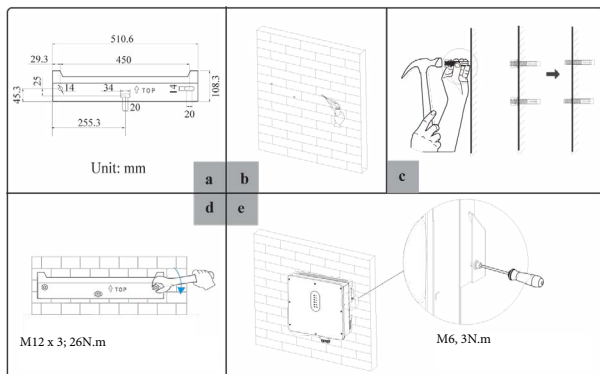



## **PERICOL**

Înainte de a găuri peretele asigurați-vă că nu veți deteriora cabluri electrice sau țevi de apă.



## **AVERTISMENT**

Pentru a preveni potențialele distrugerii și răni, nu dați drumul invertorului înainte de a vă asigura că este bine fixat pe perete.

## **4 Conexiunile electrice**

### **4.1 Schema de conectare a invertorului**

Acest capitol ilustrează detaliile conectării unui invertor, hibrid. Conectiunea PV nu este disponibilă în cazul unui Invertor cuplat la AC

Ilustrațiile următoare prezintă invertorul hibrid ca și exemplu.

## Mod de conectare non-parallel

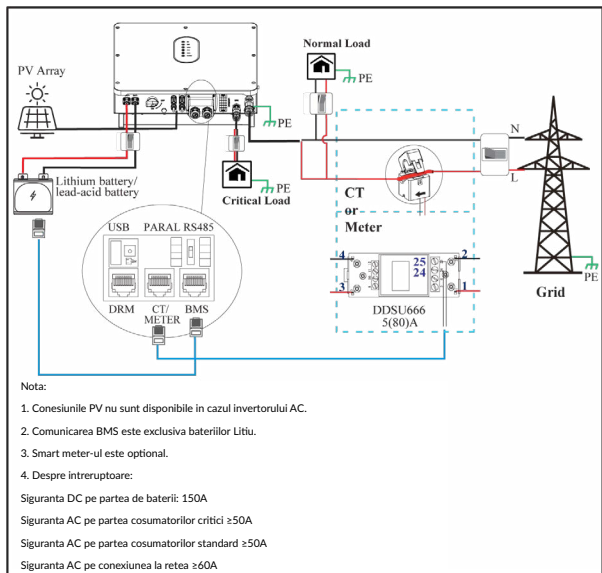

### PERICOL

Asigurati-va ca invertorul si toate conexiunile exterioare lui sunt oprite in timpul conexiunilor. In caz contrar, riscati raniri fatale cauzate de tensiunile inalte de curent continuu sau alternativ.

## Mod de conectare in paralel - schema A (Sub 5 invertoare)

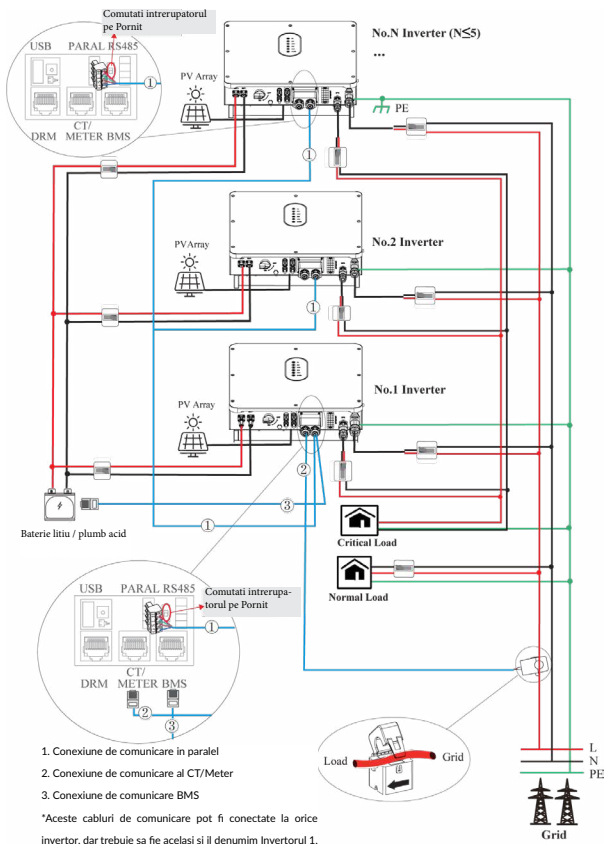

### Note pentru schema A:

1. Conexiunile PV nu sunt disponibile in cazul invertorului AC.
2. Comunicarea BMS este exclusiva bateriilor Litiu.
3. Poate fi necesar sa achizitionati senzorul CT sau smart meter in conformitate cu cerintele specifice conexiunii in paralel - Schema B.
4. Este necesara comutarea pe statusul Pornit a rezistentei de interconectare pe Invertorul cu numarul 1 si N pentru a activa conexiunea in paralel.
5. In modul de conectare in paralel, este necesar sa conectati App la unu din invertoare apoi sa mergeti la Console>Other settings pentru a activa optiunea Mod Paralel. Mai multe detalii la pag. 115.

Despre sigurante / intrerupatoare:

Siguranta DC pe partea de baterii: 150A

Siguranta AC pe partea cosumatorilor critici  $\geq 50A$

Siguranta AC pe partea cosumatorilor standard  $\geq 50A$

Siguranta AC pe conexiunea la retea  $\geq 60A$



### **PERICOL**

Asigurati-va ca in timpul instalarii invertorului toate cablurile care vor fii conectate la invertor nu sunt conectate la tensiune. In caz contrar, riscati raniri fatale cauzate de tensiunile inalte de curent continuu sau alternativ.

## Mod de conectare in paralel - schema B (peste 5 invertoare)

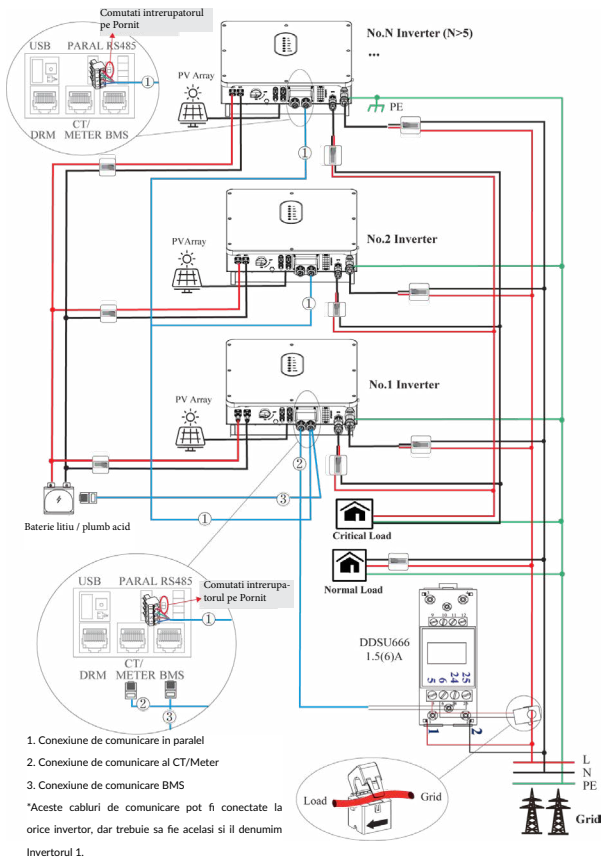

## Note pentru schema B:

1. Conexiunile PV nu sunt disponibile in cazul invertorului AC.
2. Comunicarea BMS este exclusiva bateriilor Litiu.
3. Poate fi necesar sa achizitionati senzorul CT sau smart meter in conformitate cu cerintele specifice conexiunii in paralel - Schema B.
4. Este necesara comutarea pe statusul Pornit a rezistentei de interconectare pe Invertorul cu numarul 1 si N pentru a activa conexiunea in paralel.
5. In modul de conectare in paralel, este necesar sa conectati App la unu din invertoare apoi sa mergeti la Console>Other settings pentru a activa optiunea Mod Paralel. Mai multe detalii la pag. 65.
6. Despre sigurante / intreruptoare:  
Siguranta DC pe partea de baterii: 150A  
Siguranta AC pe partea cosumatorilor critici  $\geq 50A$   
Siguranta AC pe partea cosumatorilor standard  $\geq 50A$   
Siguranta AC pe conexiunea la retea  $\geq 60A$

### PERICOL

Asigurati-va ca invertorul si toate conexiunile exterioare lui sunt oprite in timpul procesului de conectare. In caz contrar, riscati raniri fatale cauzate de tensiunile inalte de curent continuu sau alternativ.

## 4.2 Impamantarea

Terminalul de impamantare (PE) este instalat in ambele parti ale invertorului. Aveti in vedere sa conectati acest terminal la bara PE pentru izolare. Cabluri galbene-verzi de 10-12 sunt recomandate

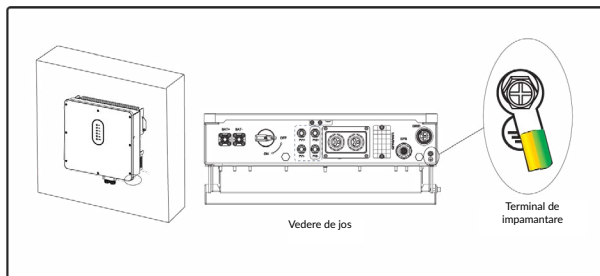



## PERICOL

Invertorul trebuie sa fie legat la impamantare pentru a nu va supune la risc de electrocutare.

## ATENTIONARE

Daca polul negativ sau cel pozitiv al panourilor solare necesita impamantare, atunci iesirea de la invertor (catre retea AC) trebuie izolata cu transformator in concordanta cu standardul IEC62109-1, -2.

### 4.3 Conectarea la retea / EPS

Inainte de a conecta terminalul GRID/EPS, asigurati-va ca atat terminalul AC, cat si terminalul CC sunt oprite, iar comutatorul PV este oprit. In caz contrar, exista riscul de soc electric. Pentru conexiunea retea/EPS va rugam sa consultati figura de mai jos

#### Pasul 1: Asamblati conectorul AC.

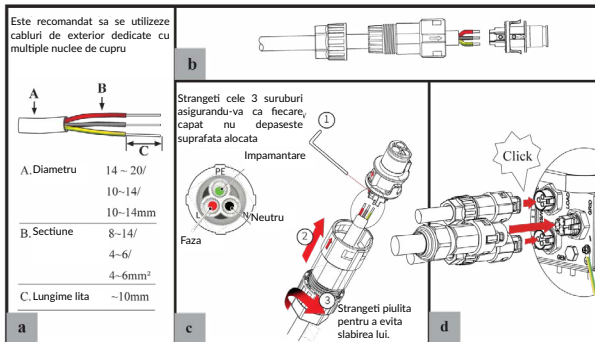
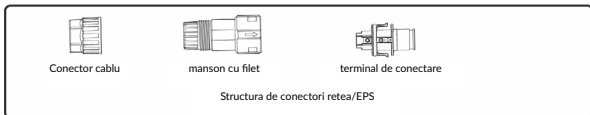

## Pasul 2: Bransati conectorul AC.

Un circuit de izolare pentru AC ar trebui instalat intre inverter si retea/EPS.

- Inainte de a conecta cablul AC de la inverter la circuitul de izolare, confirmati ca acesta functioneaza, print-un mic test.
- Conectati conductorul PE la electrodul de impamantare si conectati firul N si L la circuitul / intrerupatorul AC.
- Conectati intrerupatorul AC la retea/EPS



### NOTIFICARE

- Invertoare multiple nu trebuie legate la acelasi circuit de izolare.
- Consumatorii nu trebuie legati intre inverter si intrerupatorul AC.

Pentru a va asigura ca inverterul poate fi deconectat in siguranta de la retea , o siguranta AC ( $\geq 50A$ ) trebuie instalata exclusiv pentru portul retea/EPS.

## 4.4 Conectarea bateriilor

Inverterul hibrid sustine doar baterii pe tehnologie Litiu sau Pb-acid. Aceasta sectiune din manual ilustreaza conectarea bateriilor la inverter

Daca aveti nevoie de mai multe detalii despre baterii consultati documentatia aferenta bateriilor utilizate.

Inainte de conectarea bateriilor instalati o siguranta pe circuitul DC (150A) intre inverter si baterii. Acest lucru asigura deconectarea pentru mentenanta

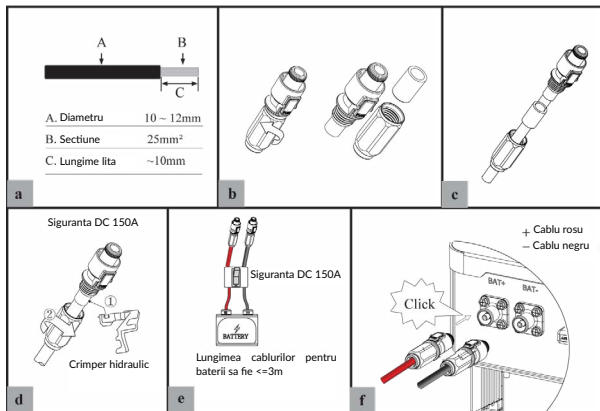

### AVERTISMENT

- Polaritatea inversata va defecta invertorul.
- Atentie ridicata la pericolele electrice si chimice.
- Pentru a evita pericolele folositi specificatiile corecte ale cablurilor.

### Conexiunea sistemului de management al bateriilor

Daca utilizati baterii litiu, va trebui stabilita conexiunea dintre sistemul de management al bateriilor si invertor. Vedeti sectiunea 4.7.1 pentru detalii.

## 4.5 Conectarea panourilor PV

Vedeti diagrama de mai jos.

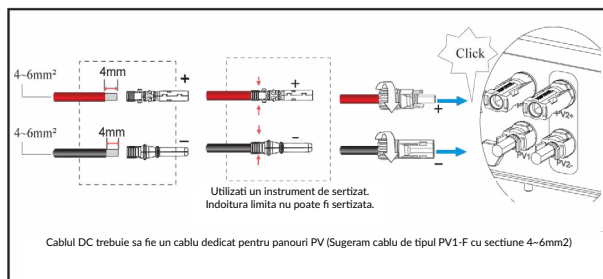

### NOTIFICARE

- Inainte de conectarea panourilor PV, asigurati-va ca polaritatea a fost respectata. Polaritatea inversata poate distruge iremediabil invertorul.
- Panourile PV nu trebuie conectate la conductorul de impamantare.
- Rezistenta minima de izolare fata de impamantare a panourilor trebuie sa fie mai mare de 18.33kOhmi. Exista risc ridicat de electrocutare in cazul in care nu se respecta aceasta specificatie.

## 4.6 Conectarea CT/meter

Monitorizarea se va realiza printr-un meter sau CT.

### 4.6.1 Conectarea meterului

Aceasta secțiune se adresează modului de conectare non-paralel. Invertorul hibrid este compatibil doar cu meterul DDSU666. Acesta este opțional.

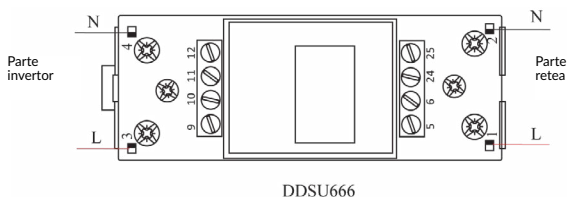

Înainte de conectarea acestuia la rețea, instalați o siguranță AC separată ( $\geq 60A$ ) între meter și rețea. Acest lucru asigură mentenanța în siguranță.

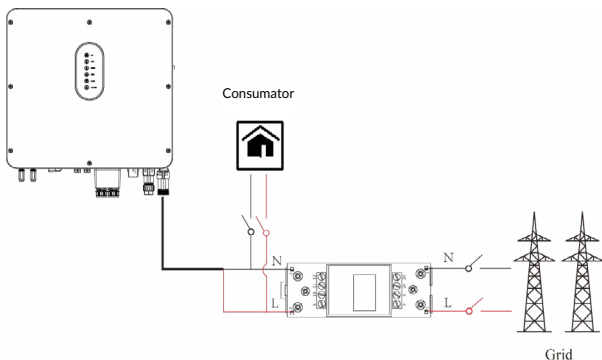

Va rugăm să consultați documentația meterului pentru detalii.

## 4.6.2 Conectarea CT

Înainte de conectarea acestuia la rețea, instalați o siguranță AC separată ( $\geq 60A$ ) între CT și rețea. Acest lucru asigură mentenanța în siguranță.

Diagrama de conectare a CT mai jos:

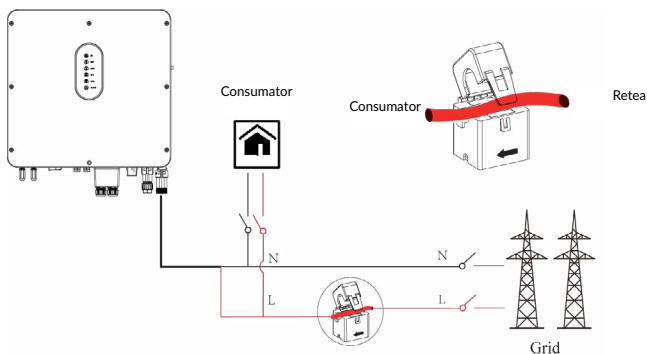

Va rugăm să conectați cu atenție CT-ul (current interchanger). Sageata de pe carcasă CT indică direcția de curgere a curentului dintre rețea spre invertor. Conectați senzorul CT pe fază, prin orificiile de detectare.

### NOTIFICARE!

*Direcția curentului de la rețea către invertor este definită ca pozitiv, iar în direcție inversă de la invertor spre rețea este definită ca negativ.*

## 4.7 Conexiune de comunicare

Interfata de comunicare poate fi stabilita prin portul de comunicare al inverterului, in partea de sub inverter cum e prezentat mai jos:

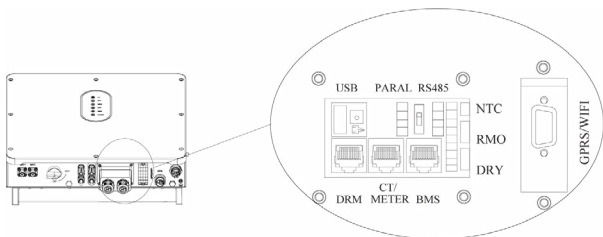

Interfata	Descriere	
USB	Pentru actualizare firmware	
PARAL	Interfata cu 4-pini pentru comunicare in paralel	
	Comutatorul rezistentei de potrivire pentru comunicarea in modul paralel	
RS485	Interfata cu 4-pini pentru comunicare RS485	
DRM	Mod de raspuns la cereri	
CT/METER	Comunicatia cu Smart Meter-ul sau cu CT-ul	
BMS	Interfata de comunicare pentru bateriile Litiu	
9-Pins	NTC	Terminal pentru senzor de temperatura al bateriilor cu Pb-acid
	RMO	Oprire la distanta
	DRY	Control DO
GPRS/WIFI	Pentru comunicarea GPRS/WI-FI.	

### 4.7.1 Conexiune BMS (doar pentru baterii Litiu)

#### Configuratia terminalelor in comunicarea cu bateriile (BMS)

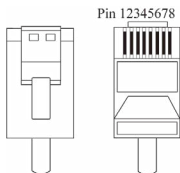

PIN	1	2	3	4
Descrierea functiei	RS485_A	RS485_B	GND_S	GND_S

PIN	5	6	7	8
Descrierea functiei	GND_S	GND_S	CAN_L	CAN_H

Acest manual prezinta ordinea cablurilor la inverter. Pentru detalii despre baterii consultati documentatia aferenta

#### Urmati urmatoorii pasi:

**a** Desurubati capatul rezistent la apa si slabiti piulita de cauciuc.

**c**

1. Introduceti terminalul RJ45 in porturile corespunzente.
2. Insurubati capatul rezistent la apa cu suruburi de tip M4x4 (1.2Nm)
3. Instalati acoperitoarea pe mansonul cu filet si strangeti piulita de cauciuc.

**b** Asamblati terminalul RJ45 conform cu descrierea fiecarui pin. Treceti cablul BMS prin piulita din cauciuc, izolati cu capatul rezistent la apa.

Nu taiati niciun cablu de comunicare.

Treceti cablul BMS prin acoperitoare cu ajutorul canalelor laterale.



## 4.7.2 Conexiune DRM

DRM (Demand Response Mode) este un mod in care invetorul este pregatit pentru a raspunde cererilor de comunicare. Este o cerinta obligatorie in legislatia din Australia.

### NOTA!

In cazul nevoii conexiunii DRM, este necesara activarea acesteia din Aplicatia de mobil din Console>Other Setting. Vezi pagina 146

**Configurarea conectorului RJ45 in cazul conexiunii DRM.**

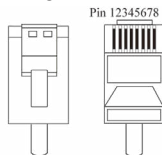

PIN	1	2	3	4
Descrierea functiei	DRM1/5	DRM2/6	DRM3/7	DRM4/8

PIN	5	6	7	8
Descrierea functiei	REF	DRM 0/COM	NC	NC

Urmati urmatoorii pasi:

**a** Desurubati capatul rezistent la apa si slabiti piulita de cauciuc.

**b** Asamblati terminalul RJ45 conform cu descrierea fiecarui pin. Treceti cablul BMS prin piulita din cauciuc, izolati cu capatul rezistent la apa.

**c**

1. Introduceti terminalul RJ45 in porturile corespunzatoare.
2. Insurubati capatul rezistent la apa cu suruburi de tip M4x4 (1.2Nm)
3. Instalati acoperitoarea pe mansona cu filet si strangeti piulita de cauciuc.

**Nu taiati niciun cablu de comunicare.**

Treceti cablul DRM prin acoperitoarea cu ajutorul canalelor laterale.

### 4.7.3 Conexiune senzor CT/Meter

#### Configurarea prin terminalul RJ45

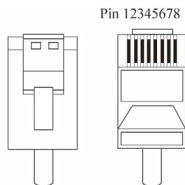

PIN	1	2	3	4	5	6	7	8
Descriere functie	RS485_A	RS485_B	RS485_A	RS485_B	CT-	CT+	NC	NC

#### 4.7.3.1 Conexiune meter

##### Prezentare conexiune cablu meter

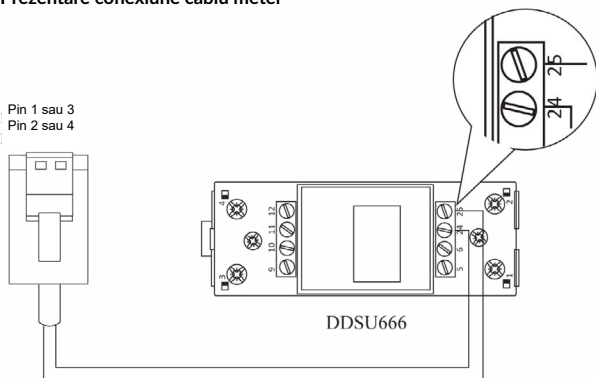

Invertor	meter
Pin1 sau Pin3(RS485_A )	Pin24
Pin2 sau Pin4(RS485_B )	Pin25

## Conectare meter. Urmarii pasii:

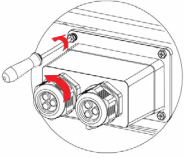
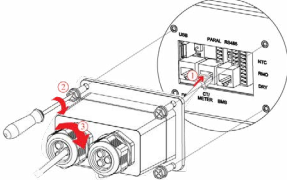
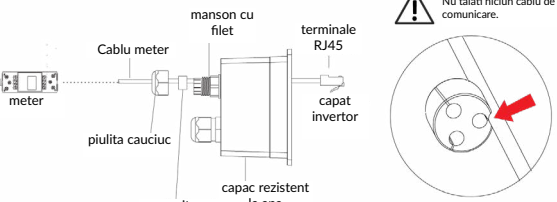
 <p><b>a</b> Desurubati capatul rezistent la apa si slabiti piulita de cauciuc.</p>	 <p><b>c</b></p> <ol style="list-style-type: none"><li>1. Introduceti terminalul RJ45 in porturile corespunzatoare.</li><li>2. Insurubati capatul rezistent la apa cu suruburi de tip M4x4 (1.2Nm)</li><li>3. Instalati acoperitoarea pe mansonul cu filet si strangeti piulita de cauciuc.</li></ol>
<p><b>b</b> Asamblati terminalul RJ45 conform cu descrierea fiecarui pin. Treceti cablul meter prin piulita din cauciuc, izolati cu capatul rezistent la apa.</p>  <p>Nu taiati niciun cablu de comunicare.</p> <p>Treceti cablul meter prin acoperitoare cu ajutorul canalelor laterale.</p>	

### 4.7.3.2 Conexiune CT

Secțiunea următoare este aplicabilă modului de conectare non-paralel și paralel - schema A.

#### Descriere cablu de conectare CT

Pin 5,6

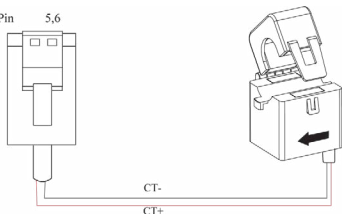

Invertor	CT
Pin5(CT-)	Negru
Pin6(CT+)	Rosu

#### Conectare CT. Urmati pasii:

**a** Desurubati capacul rezistent la apa si slabiti piulita de cauciuc.

**c**

1. Introduceti terminalul RJ45 in porturile corespunzatoare.
2. Insurubati capacul rezistent la apa cu suruburi de tip M4x4 (1.2Nm)
3. Instalati acoperitoarea pe mansionul cu filet si strangeti piulita de cauciuc.

**b** Asamblati terminalul RJ45 conform cu descrierea fiecarui pin. Treceti cablul meter prin piulita din cauciuc, izolati cu capacul rezistent la apa.

Labels: cablu CT, mansion cu filet, terminale RJ45, piulita cauciuc, acoperitoare, capac rezistent la apa, capat invertor.

Nu taiati niciun cablu de comunicare.

Treceti cablul meter prin acoperitoare cu ajutorul canalelor laterale.

## 4.7.4 Conexiune RS485

### Configuratia cu 4 pini a comunicarii RS485:



PIN	A	B	PE	PE
Descrierea functiei	RS485_A	RS485_B	PE	PE

### Conectare RS485. Urmati urmatoorii pasi:

**a** Desurubati capatul rezistent la apa si slabiti piulita de cauciuc.

1. Introduceti terminalul cu 4 pini in porturile corespunzatoare.
2. Insurubati capatul rezistent la apa cu suruburi de tip M4x4 (1.2Nm)
3. Instalati acoperitoarea pe mansoul cu filet si strangeti piulita de cauciuc.

**b** Asamblati terminalul cu 4 pini conform cu descrierea fiecarui pin.  
Treceti cablul RS485 prin piulita din cauciuc, izolati cu capatul rezistent la apa.

modul de control RS485, cablu RS485, mansou cu filet, terminale RJ45(4-pini), capatul invertor, piulita cauciuc, acoperitoare, capac rezistent la apa.

**! Nu taiati niciun cablu de comunicare.**

Treceti cablul RS485 prin acoperitoare cu ajutorul canalelor laterale.

## 4.7.5 Conectarea comunicării în paralel

### Configurarea terminalului cu 4 pini



PIN	G	S	L	H
Descrierea funcției	GND_S	PARA_SYNC	CAN_L	CAN_H

### Descrierea cablului de comunicare a terminalului cu 4 pini

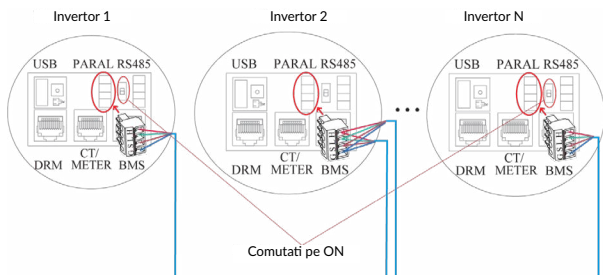

În cazul conectării în mod paralel este necesară comutarea pe ON a rezistenței de potrivire de pe invertorul 1 și de pe invertorul N.

Master Inverter	No. 1 Slave Inverter	No. N Slave Inverter
PinH(CAN_H)	PinH(CAN_H)	PinH(CAN_H)
PinL(CAN_L)	PinL(CAN_L)	PinL(CAN_L)
PinS(PARA_SYNC)	PinS(PARA_SYNC)	PinS(PARA_SYNC)
PinG(GND_S)	PinG(GND_S)	PinG(GND_S)

## Urmati pasii:

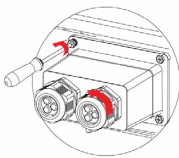
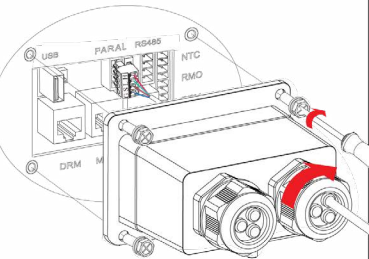
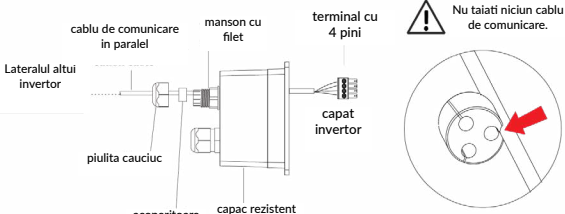
 <p><b>a</b> Desurubati capul rezistent la apa si slabiti piulita de cauciuc.</p>	 <p><b>c</b></p> <ol style="list-style-type: none"><li>1. Introduceti terminalul cu 4 pini in porturile corespunzatoare.</li><li>2. Insurubati capul rezistent la apa cu suruburi de tip M4x4 (1.2Nm)</li><li>3. Instalati acoperitoarea pe mansoul cu filet si strangeti piulita de cauciuc.</li></ol>
<p><b>b</b> Asamblati terminalul cu 4 pini conform cu descrierea fiecarui pin. Treceti cablul RS485 prin piulita din cauciuc, izolati cu capul rezistent la apa.</p>  <p><b>Nu taiati niciun cablu de comunicare.</b></p> <p>Treceti cablul RS485 prin acoperitoare cu ajutorul canalelor laterale.</p>	

## 4.7.6 Conexiunile NTC/RMO/DRY

### Configurarea terminalului cu 9 pini ale comunicatiilor auxiliare

Pin123456789



PIN	Descrierea functiei
1	NO1 (Deschis normal)
2	N1
3	NC1 (Inchis normal)
4	NC2 (Inchis normal)
5	N2
6	NC2 (Inchis normal)
7	REMO OFF
8	GND S (NTC BAT)
9	NTC BAT+

#### Urmati urmatoorii pasi:

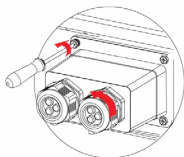

Desurubati capatul rezistent la apa si slabiti piulita de cauciuc.

a

b

Instalati terminalul cu 9 pini conform cu descrierile porturilor auxiliare pe care doriti sa le folositi.

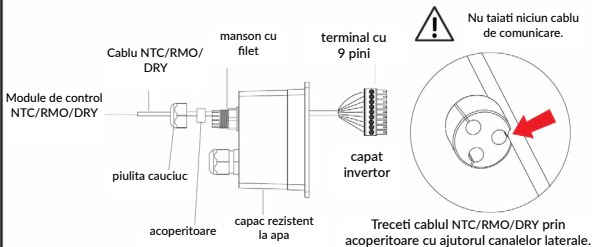



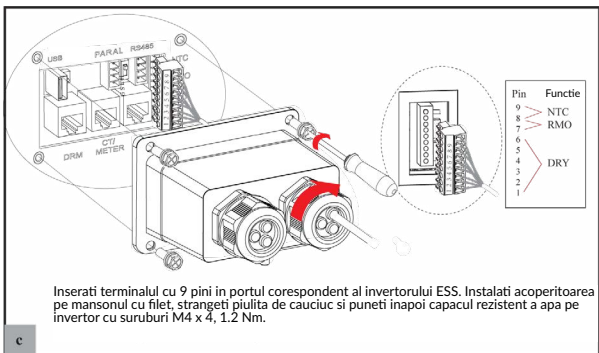

#### 4.6.7 Conexiunea modului GPRS/Wifi (optional)

Pentru conexiunea modului GPRS/Wifi urmati schema de mai jos.  
Pentru detalii despre setarile aplicatiei, cititi documentatia modului GPRS/Wifi.

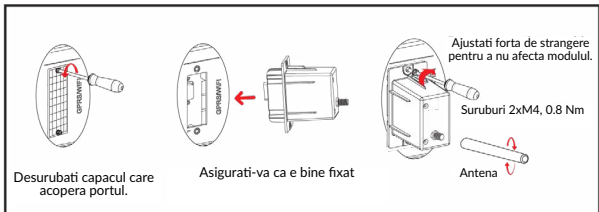

### 5.1 Mod de functionare

Invertorul poate functiona in diverse moduri de operare.

#### 5.1.1 Mod consum propriu (self use mode)

Mergeti la meniul Hybrid work mode si selectati Self used mode. Sub acest mod energia generata de panouri va fi prioritizata astfel Consumator > Baterii > Retea, ceea ce inseamna ca echipamentele conectate local vor consuma majoritatea energiei electrice, excesul va merge in a incarca bateriile si daca mai ramane se va injecta in retea publica.

Acest mod este cel implicit de functionare, pentru a optimiza consumul local. Acest mod este divizat in alte moduri de functionare.

#### a) Energie solara abundenta

Cand energia fotovoltaica este abundenta, energia va fi prioritizata catre consumatori, apoi incarcarea bateriilor iar apoi ce ramane va fi injectat in grid.

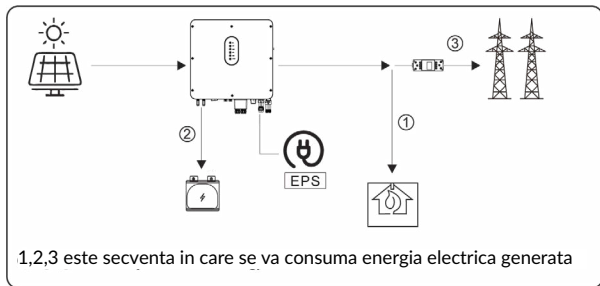

#### b) Energie solara insuficienta

Cand energia captata este insuficienta pentru a acoperi toti consumatorii, invertorul va suplini cu energia stocata in baterii, iar daca mai este nevoie isi va lua necesarul din retea publica.

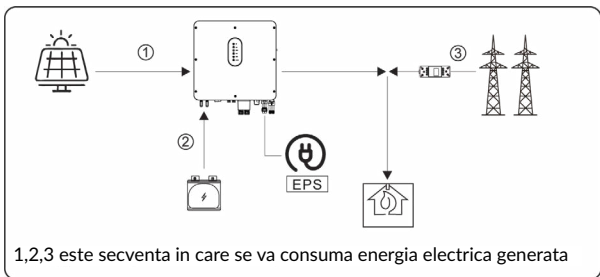

c) Fara energie solara (in zile ploioase, inchise)

Invertorul va furniza energia stocata in baterii pentru consumatorii casnici. In cazul in care consumul nu poate fi acoperit se va utiliza curent din retea.

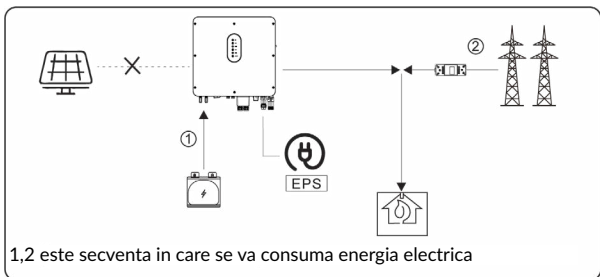

### 5.1.2 Modul de prioritate alimentare retea (Feed-in priority mode)

Mergeti la meniul Hybrid work mode si selectati Feed-in priority mode. Sub acest mod energia generata de panouri va fi prioritizata astfel Consumator > Rețea > Baterii, ceea ce inseamna ca echipamentele conectate local vor consuma energia captata, iar excesul va fi injectat in rețeaua electrica si in caz de surplus, bateriile vor fi alimentate.

a) Energie solara abundenta

Cand energia fotovoltaica este abundenta, curentul va fi prioritizat catre consumatori, apoi alimentarea rețelei și apoi încărcarea bateriilor.

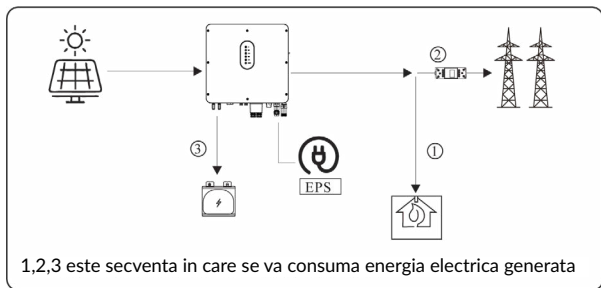

b) Energie solara insuficienta

Cand energia generată este insuficientă pentru alimentarea rețelei publice, energia din baterii va fi folosită.

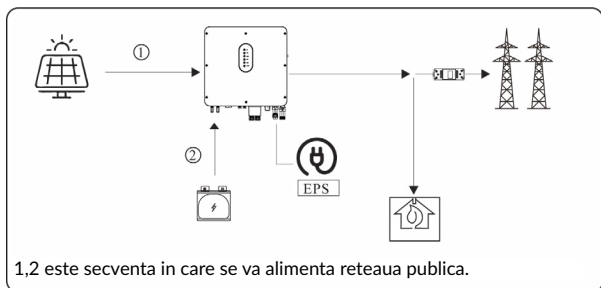

c) Fara energie solara (in zile ploioase, inchise)

Invertorul va furniza energia stocata in baterii pentru consumatorii casnici.  
In cazul in care consumul nu poate fi acoperit se va utiliza curent din retea.

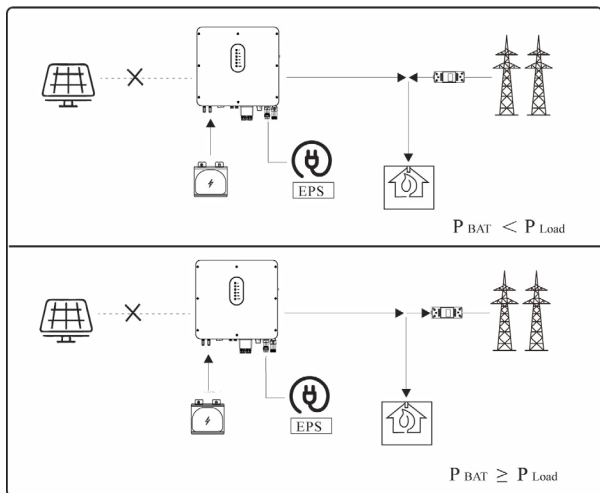

### 5.1.3 Modul control bazat pe timp (Time-Based Control Mode)

Mergeti la meniul Hybrid work mode si selectati Time-Based Control Mode. Sub acest mod, utilizatorul poate controla incarcarea si descarcarea bateriei. Urmatorii parametrii se pot ajusta:

- Frecventa incarcare / descarcare : o data sau zilnic.
- Timp de incepere a incarcarii 0 la 24 ore.
- Timp de oprire a incarcarii 0 la 24 ore.
- Timp de incepere a descarcarii: 0 la 24 ore.
- Timp de oprire a descarcarii 0 la 24 ore.

Tot in acest mod se poate ajusta daca rețeaua va incarca bateriile, acest lucru fiind oprit implicit. Daca utilizatorul activeaza optiunea Grid charge function, parametrii Maximum grid charger power si Capacity of grid charger end pot fi setati. In momentul in care parametru setat Capacity of grid charger end va fi atins, rețeaua va opri incarcarea bateriilor.

### 5.1.4 Modul de rezerva (Back-up mode)

Mergeti la meniul Hybrid work mode si selectati Back-up mode. Sub acest mod prioritizarea consumului va fi Baterii> Cosumatori>Retea.

In acest mod se urmareste incarcarea rapida a bateriilor. In acest scop se poate activa optiunea de incarcare a bateriilor folosind energia din retea publica.

#### Incarcarea bateriilor din retea publica este Dezactivata

In acest mod, bateriile vor fi incarcate exclusiv cu energie generata fotovoltaic, iar puterea de incarcare va varia in concordanta cu puterea captata de panouri.

##### a) Energie solara abundenta

Cand energia fotovoltaica este abundenta, energia va fi prioritizat catre baterii, apoi catre consumatori apoi surplusul va fi injectat in retea.

1,2,3 este secventa in care se va consuma energia electrica de la PV

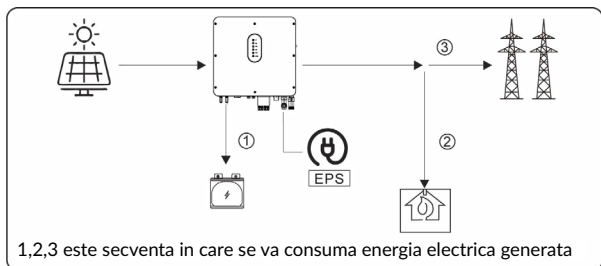

##### b) Energie solara insuficienta

Cand energia generata este insuficienta, aceasta se va folosi prioritar pentru incarcarea bateriilor. Consumatorii vor fi alimentati de retea.

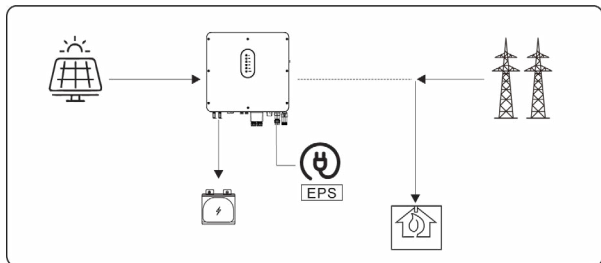

## Incarcarea bateriilor din rețeaua publică este Activată

În această situație, bateriile vor fi încărcate cu energie generată fotovoltaică și/sau cu cea din rețeaua publică.

### a) Energie solară abundentă

Când energia fotovoltaică este abundentă, curentul va fi prioritizat către baterii, apoi consumatori, apoi surplusul va fi injectat în rețea. 1,2,3 este secvența în care se va consuma energia electrică de la PV.

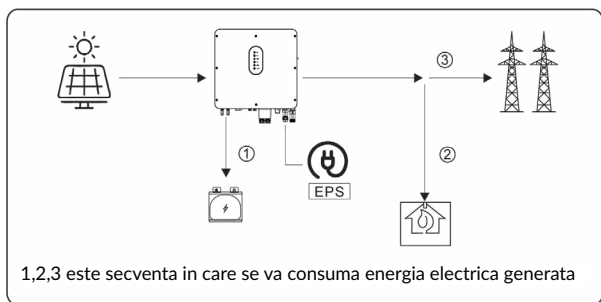

### b) Energie solară insuficientă

Când energia generată este insuficientă pentru încărcarea bateriilor se va suplini necesarul cu energie de la rețeaua publică. Consumatorii vor fi alimentați de rețea.

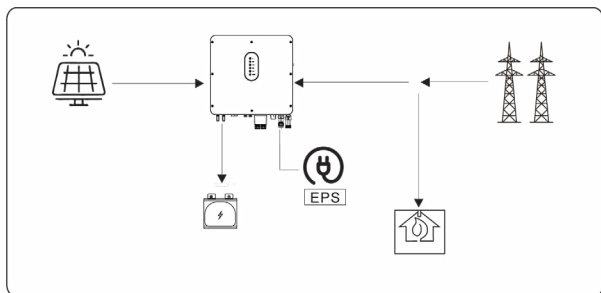

### 5.1.5 Modul Fara retea (Off Grid Mode)

Cand curentul de la retea este oprit, sistemul va trece automat in acest mod. Doar consumatorii critici vor fi alimentati.

In acest mod, invertorul nu poate functiona fara baterii conectate.

#### a) Energie solara abundenta

Cand energia fotovoltaica este abundenta, energia generata de panouri va fi furnizata consumatorilor critici, apoi incarcarii bateriei si in ultimul rand, conditionat, consumatorilor casnici standard (doar daca puterea din panouri este mai mare de 500W si starea de incarcare a bateriilor este de peste 90%).

1,2 este secventa in care se va consuma energia electrica de la PV.

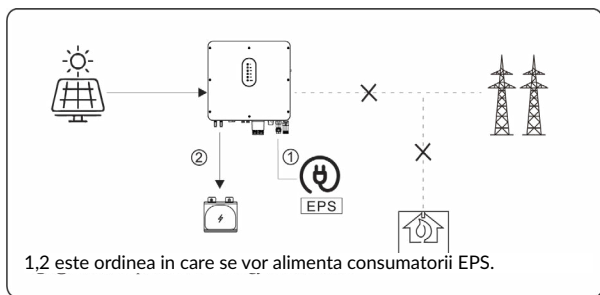



## b) Energie solara insuficienta

Cand energia generata este insuficienta, consumatorii EPS sunt alimentati de catre energia de la PV si apoi de cea stocata in baterii.

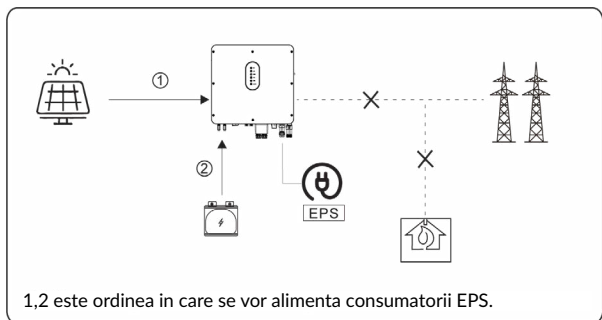

### NOTIFICARE

- In acest mod, setati voltajul si frecventa la iesire. Este recomandata alegerea unor baterii cu capacitatea mai mare de 100Ah pentru a asigura functionarea normala a EPS.
- Daca incarcarea la iesirea EPS este inductiva sau capacitiva, pentru a asigura stabilitatea sistemului, configurati consumul la 50% din intervalul maxim suportat.

## 5.2 Pornirea/Oprirea sistemului

### 5.2.1 Pornirea sistemului

Verificati ca intregul sistem este sigur si solid, iar impamantarea este corecta. Apoi verificati conexiunile AC, baterie, panouri etc sa fie corect legate. Confirmati parametrii conformi cu cerintele.

Frecventa AC 50/60Hz	Tensiune de la PV 90-530V
Tensiune baterie 42-60V	Tensiune AC retea 180-270V

Verificati ca parametrii de mai sus sa fie corecti, apoi urmati procedura de pornire a invertorului:

- 1) Porniti AC.
- 2) Porniti PV.
- 3) Porniti sistemul de baterii.
- 4) Conectati aplicatia telefonului prin intermediul Bluetooth. Verificati seciunea 7.2 pentru detalii.
- 5) Porniti din aplicatie invertorul de pe buton Power On. Verificati seciunea 7.2 pentru detalii.

### 5.2.2 Oprirea sistemului

Daca este necesara inchiderea sistemului, urmati procedura urmatoare:

- 1) Conectati telefonul la Bluetooth, apoi deschideti aplicatia. Verificati seciunea 7.2 pentru detalii.
- 2) Inchideti din aplicatie invertorul selectand Power Off. Verificati sectiunea 7.2 pentru detalii.
- 3) Inchideti sistemul de baterii.
- 4) Inchideti PV.
- 5) Inchideti AC.
- 6) Daca trebuie sa deconectati cabluri de la invertor, asteptati 5 minute inainte de aceasta operatiune.

Punerea in functiune a sistemului trebuie sa fie realizata de catre un instalator autorizat. Acest lucru va proteja impotriva pericolelor de incendiu, electrocutari si alte daune ori vatamari.

### 6.1 Inspectia

Inainte de punerea in functiune propriu-zisa, instalatorul autorizat trebuie sa faca o inspectie extensiva a sistemului si sa se asigura ca:

- 1) Sistemul este instalat corect, conform intructiunilor din acest manual si este prevazut cu suficient spatiu pentru ventilatie, functionare si mentenanta.
- 2) Toate terminalele sunt in conditie buna si nu sunt deteriorate.
- 3) Niciun obiect nu este plasat pe invertor sau in spatiul de functionare necesar.
- 4) Panourile fotovoltaice, sistemul de baterii si conexiunea la rețeaua electrica functioneaza in parametrii normali.

### 6.2 Procedura de punere in functiune

Dupa inspectie si luarea la cunostinta ca toate cerintele au fost respectate cu strictete, se poate incepe punerea in functiune a invertorului.

- 1) Porniti invertorul prin procedura de la sectiunea de pornire 5.2.1
- 2) Setati parametrii din aplicatie conform cu cerintele utilizatorului.
- 3) Finalizati punerea in printr-o inspectie amanuntita.

## 7 Interfata utilizatorului

### 7.1 LED

Aceasta sectiune descrie panoul LED si indicatorii de stare pentru PV, BAT, GRID, EPS, COM, ALARM. Mai jos este detaliata starea fiecarui indicator in functie de comportamentul semnalat.

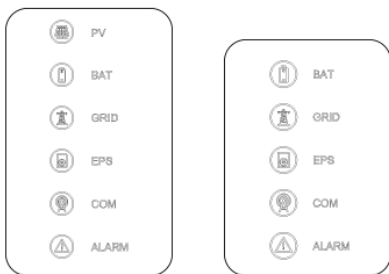

Indicator LED	STARE	Descriere
PV	Pornit	Intrare PV normala
	Intermitent	Intrare PV atipic
	Oprit	Lipsa PV
BAT	On	Bateria se incarca
	Intermitent	Bateria se descarca Baterie atipica.
	Oprit	Lipsa baterie
GRID	Pornit	Reteaua este stabila si functioneaza
	Intermitent	Reteaua este instabila si functioneaza
	Oprit	Lipsa retea.
COM	Pornit	Comunicatie pornita.
	Oprit	Lipsa alimentare.
EPS	Pornit	Alimentare EPS functioneaza.
	Intermitent	lesire EPS instabila.
	Oprit	Lipsa alimentare EPS.
ALARM	Pornit	Eroarea s-a produs si invertorul se inchide
	Intermitent	Alarma s-a produs dar invertorul nu se inchide.
	Oprit	Fara erori.

Detalii	COD	PV LED	Grid LED	BAT LED	EPS LED	COM LED	ALARM LED
PV stabil		●	○	○	○	○	○
Fara PV		○	○	○	○	○	○
PV supratensiune	B0						
PV sub tensiune	B4						
Radiatie PV slaba	B5	★	○	○	○	○	○
PV sir inversat	B7						
PV sir atipic	B3						
Pe retea		○	●	○	○	○	○
Retea supratensiune	A0						
Retea subtensiune	A1						
Retea absenta	A2						
Retea depaseste frecventa	A3	○	★	○	○	○	○
Retea sub frecventa	A4						
Retea atipica	A6						
Retea supra tensionata peste medie	A7						
Fir neutru inversat	A8						
Baterie incarcare		○	○	●	○	○	○
Baterie lipsa	D1	○	○	○	○	○	○
Baterie descarcare		○	○	★★	○	○	○
Baterie sub tensiune	D3						
Baterie supratensiune	D2						
Descarcare baterie supracurent	D4						
Baterie temperatura ridicata	D5	○	○	★	○	○	○
Baterie temperatura normala	D6						
Lipsa comunicatie (Invertor-BMS)	D8						
Iesire EPS activa		○	○	○	●	○	○
Iesire EPS inactiva		○	○	○	○	○	○
Scurtcircuit EPS	DB						
Supraincarcare EPS	DC						
Supra tensiune iesire EPS atipica	D7	○	○	○	★	○	○
EPS peste tensiunea de polarizare CC	CP						

Detalii	COD	PV LED	Grid LED	BAT LED	EPS LED	COM LED	ALARM LED
RS485/DB9/BLE/USB		○	○	○	○	●	○
Invertor temperatura ridicata	C5						
Ventilator atipic	C8						
Invertor la limita	CL						
Lipsa logger de date	CH	○	○	○	○	○	★
Lipsa meter	CJ						
Control la distanta oprit	CN						
Izolarea panourilor atipica	B1						
Current atipic	B2						
Sursa de alimentare interna atipica	C0						
Curent de polarizare CC al invertorului	C2						
Relevu invertor anormal	C3						
GFCI atipic	C6						
Eroare de sistem	C7						
Tensiune dezechilibrată la legătura CC	C9						
Supratensiune DC-link	CA	○	○	○	○	○	●
Eroare interna de comunicare	CB						
Eroare interna de comunicare(E-M)	D9						
Eraore interna de comunicare(M-D)	DA						
Incompatibilitate software	CC						
Eroare stocare interna	CD						
Impuls atipic	CG						
DC-DC atipic	CU						

Referinte: ● Lumina aprinsa ○ Lumina stinsa ○ Mentine starea curenta

★ Intermitent la 1 secunda

★★ Intermitent la 2 secunde

## 7.2 Ghid de setare aplicatie

### 7.2.1 Descarcarea aplicatiei:

- Scanati codul QR de pe invertor pentru a descarca aplicatia.
  - Descarcati aplicatia din AppStore sau Google Play.
- Aplicatia necesita permisiune la locatie. O puteti activa in momentul instalarii sau mai tarziu din setarile telefonului.

### 7.2.2 Arhitectura aplicatiei

Contine Cloud login si Local Connection.

- Cloud Login: aplicatia citeste datele din serverul cloud prin API si afiseaza
- Conexiune locala: aplicatia citeste informatiile direct de la invertor prin Bluetooth si protocol Modbus pentru a afisa parametrii invertorului si permite configurarea parametrilor.



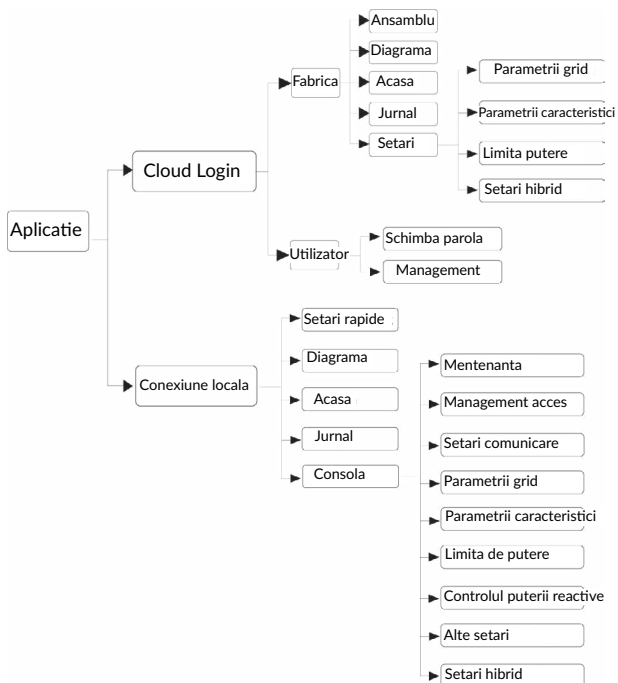

### 7.2.3 Setari locale

- **Permisune acces**

Inainte de a utiliza setarile locale, aplicatia are nevoie de unele permisiuni, de aceea activati permisiunile cerute.

- **Conexiune acces**

Activati Bluetooth pe telefon, apoi deschideti aplicatia.

Apasati pe Local Settings si mergeti la pagina de conectare. Aceasta arata inverterul pe care doriti sa il accesati sau l-ati accesat. Apasati pe numele inverterului pentru a va conecta.

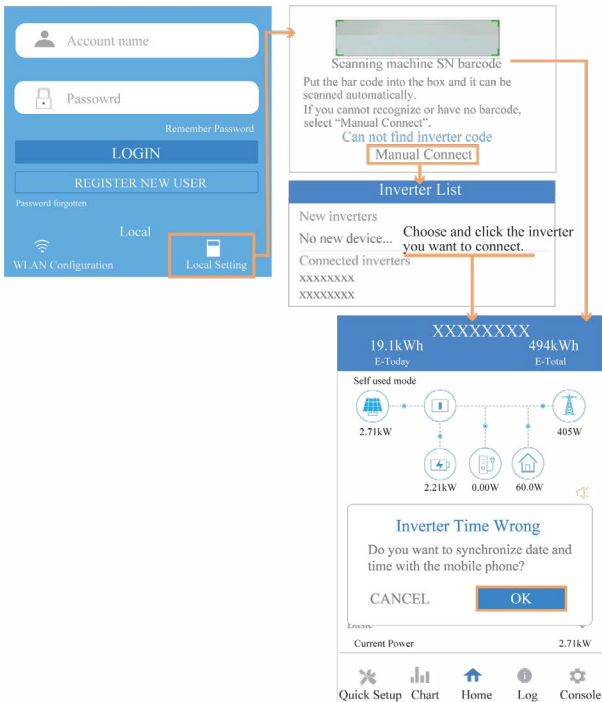

## Setari rapide

### 1. Conectati-va la ruter

Pasul 1. Mergeti la Quick Settings.

Pasul 2. Selectati fiecare element pentru a introduce informatia apoi apasati Next.

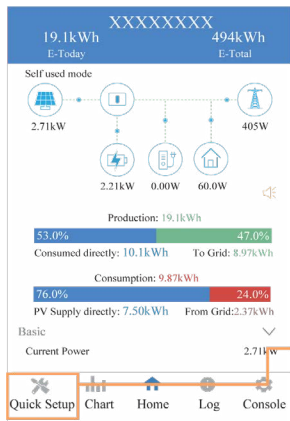

XXXXXXXXX 1

1 2 3 4 5  
Step1 Set parameters the inverter to connect to the router.

SSID  
Password

WiFi SSID      Click each item to enter the informations.  
WiFi PASSWORD

Next

### 2. Setati parametrii retelei electrice

Pasul 1. Apasati pe fiecare element pentru a seta parametrii retelei.

Pasul 2. Apasati Next.

Pasul 3. Setati parametrii de limitare putere.

XXXXXXXXX 1

1 2 3 4 5  
Step2 Set parameters for the inverter to connect to the power grid.

Standard Code  
Nominal Voltage(V)      Click to enter the informations.  
Nominal frequency (Hz)  
Date and Time

Previous      Next

Click here to back to previous setting item.

### 3. Setati parametrii de limitare putere

Pasul 1. Apasati pe fiecare element pentru a seta parametrii de limitare putere

Pasul 2. Apasati Next

Pasul 3. Apasati Previous pentru a merge inapoi.

Click each item to enter the informations

XXXXXXX

1 2 3 4 5

Step3 Set parameters for the inverter to connect to the power limit.

Power control \_\_\_\_\_

Meter location \_\_\_\_\_

Meter Type \_\_\_\_\_

Power flow direction \_\_\_\_\_

Digital meter modbus address \_\_\_\_\_

Maximum feed in grid power(W) \_\_\_\_\_

Previous Next

### 4. Setati parametrii de functionare

Pasul 1. Apasati pe fiecare element pentru a seta parametrii de functionare

Pasul 2. Apasati Next

Pasul 3. Apasati Previous pentru a merge inapoi.

XXXXXXX 1

1 2 3 4 5

Step4 Set parameters for the inverter to connect to the workmode.

Hybrid work mode \_\_\_\_\_

Battery type selection \_\_\_\_\_

EPS Output

Click to enter the informations.

Previous Next

### 5. Porniti Invertorul

Pasul 1. Apasati pe butonul de pornire.

Pasul 2. Apasati Previous pentru a merge inapoi.

XXXXXXX 1

1 2 3 4 5

Step5 Please click the button below to start the inverter.

Click to start.

Previous

- **Diagrame**

In acest meniu puteti verifica informatii de utilizare si curba de utilizare a energiei zilnic, lunar si anual.

1. Interogare date zilnice

Mergeti la Chart > Day, aici veti avea informatii despre productia zilnica si curba de utilizare. Navigarea se face stanga-dreapta.

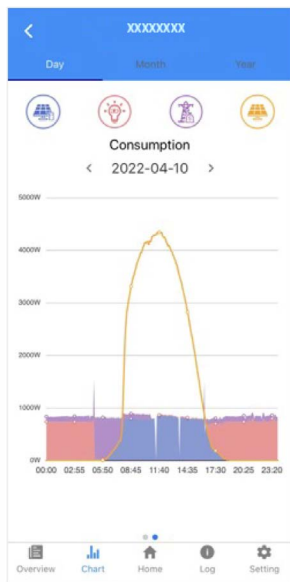
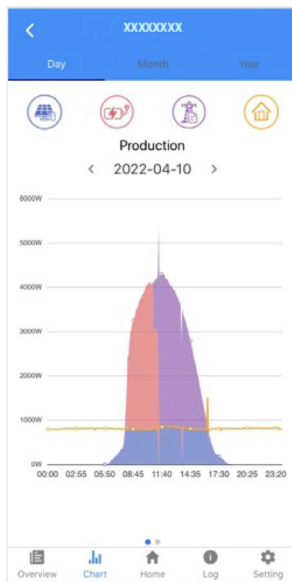

Colorile diferite reprezinta date despre fiecare element care consuma sau produce energie. Faceti click pe icoana pe care doriti sa o consultati.

In plus, puteti consulta o data specifica pe care doriti sa o verificati folosindu-va de sagetile stanga dreapta.

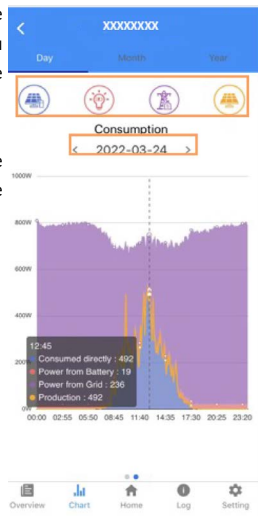

## 2. Interogare informatii lunare si anuale

Mergeti la Chart>Month sau Year, pentru a vedea consumul si productia pe intervalul de timp interogat. Navigati stanga dreapta pentru a schimba intre pagini.

Stocare informatii zilnice: 7 zile

Stocare informatii lunare: 36 luni

Stocare informatii anuale: 10 ani

- **Pagina principala Setari locale**

Aceasta pagina contine informatii generale despre invertor. Apasati pe  pentru a asculta eventualele mesaje de avertizare.

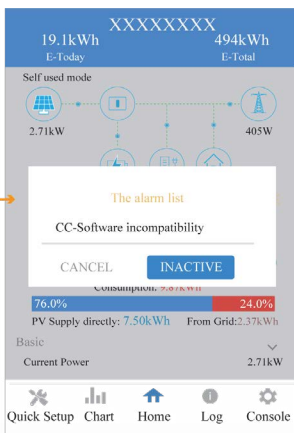
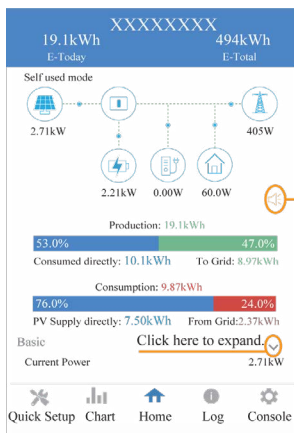

- **Istorie jurnal**

Apasati Log in josul ecranul si mergeti la date jurnal. Aici veti gasi diferite mesaje despre comportamentul invertorului.

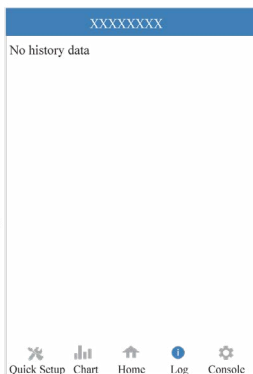
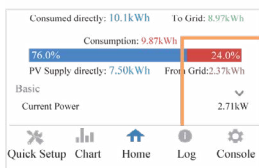

- **Mentenanata**

Mergeti la pagina Console si apasati Maintenance.

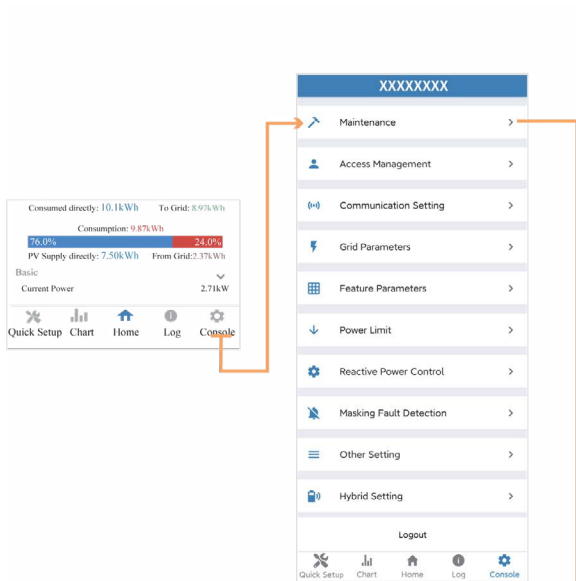

Apoi introduceti parola de administrator intr-o fereastra pop-up.

**Login As Administrator**

Enter administrator password



Aici veti avea informatii generale despre versiune, operatiuni simple de mentenanta si alte date.

**< Maintenance**

Basic information

**Model Name**  
SE 5000HB-100

**Serial number**  
2135-89030333DH

**Master DSP Version**

**Slave DSP Version**

**CSB Version**  
010403

**DC-DC converter Version**

---

Maintaining

**Power On**  
Turn on the inverter

**Power Off**  
Turn off the inverter

**Factory data reset**  
Parameters will be reset to factory data

**Clear historical information**  
Clear historical information

---

Data Management

**History export**  
All device history will be exported to root directory

**Daily energy output**  
The energy data will be exported to root directory

**Monthly Energy Yield Export**  
The energy data will be exported to root directory

**Annual output**  
The energy data will be exported to root directory

About

**App Version**  
6.5.1

- **Consola**

### Acces management

Mergeti la Console>Acces management si va puteti autentifica ca administrator sau vizitator.

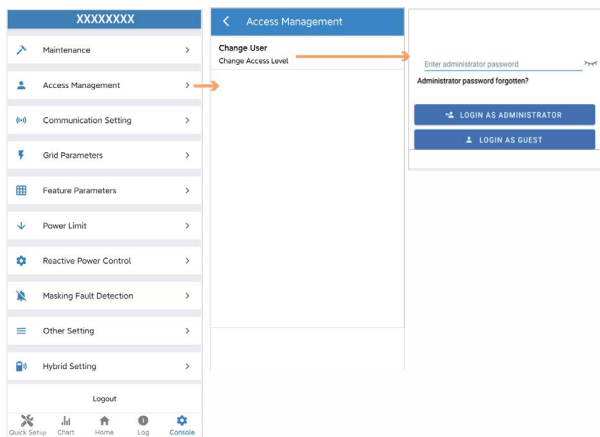

## Setari de comunicare

Mergeti la Console> Communication setting, in aceasta pagina puteti seta si schimba parametrii in care se realizeaza comunicarea, setari generale, setari RS485 si setare Ethernet

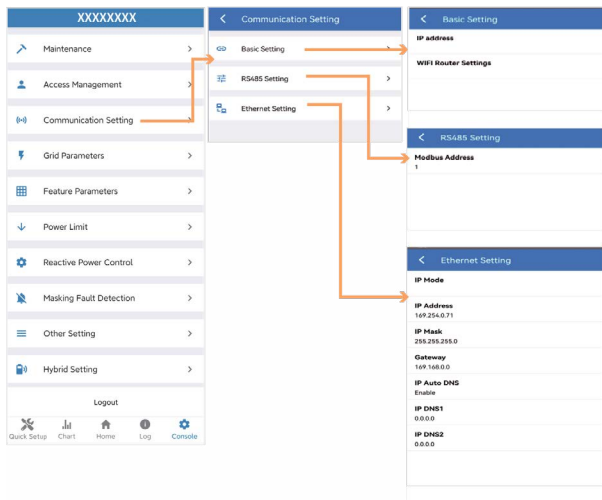

## Parametrii retea

Mergeti la Console> Grid Parameters, aici veti putea seta parametrii de retea, cum este ilustrat in figura.

## Parametrii caracteristici

Mergeti la Console>Feature Parameters, aici veti putea seta parametrii caracteristici, cum este ilustrat in figura.

## Limitare putere

Mergeti la Console> Power Limit, aici veti putea seta parametrii pentru limitatorul de putere, cum este ilustrat in figura.

The image shows a mobile application interface. At the top right is a main menu with the following items: Maintenance, Access Management, Communication Setting, Grid Parameters, Feature Parameters, Power Limit, Reactive Power Control, Masking Fault Detection, Other Setting, and Hybrid Setting. Below this menu are icons for Logout, Quick Setup, Chart, Home, Log, and Console. Three orange arrows originate from the 'Grid Parameters', 'Feature Parameters', and 'Power Limit' items in the main menu and point to three separate sub-menu screenshots below. The 'Power Limit' sub-menu shows settings for Power control, Meter location, Meter Type, Power flow direction, Digital meter modbus address, and Maximum feed in grid power(W). The 'Feature Parameters' sub-menu shows settings for Low Voltage Through, Island Detection, Isolation Detection, Leakage Current Detection(GFCI), Terminal Resistor, Derated Power(%), Power Factor, Insulation Impedance(kΩ), Leakage Current Point(mA), Unbalanced Voltage Point(%), and Moving Average Voltage Limit(V). The 'Grid Parameters' sub-menu shows settings for Standard Code, First Connect Delay Time(s), Reconnect Delay Time (s), Frequency High Loss Level\_1(Hz), Frequency Low loss Level\_1(Hz), Voltage High Loss Level\_1(V), Voltage Low Loss Level\_1(V), Frequency High Loss Time Level\_1(ms), Frequency Low loss Time Level\_1(ms), Voltage High Loss Time Level\_1(ms), Voltage Low Loss Time Level\_1(ms), Frequency High Loss Level\_2(Hz), Voltage High Loss Level\_2(V), Frequency High Loss Time Level\_2(ms), and Voltage High Loss Time Level\_2(ms).

Power Limit	Feature Parameters	Grid Parameters
<b>Power control</b> Digital Power Meter	Low Voltage Through <input type="checkbox"/>	<b>Standard Code</b> Unknown
<b>Meter location</b> On Grid	Island Detection <input type="checkbox"/>	<b>First Connect Delay Time(s)</b>
<b>Meter Type</b> CHINTDTSU666	Isolation Detection <input type="checkbox"/>	<b>Reconnect Delay Time (s)</b>
<b>Power flow direction</b> From grid to inverter	Leakage Current Detection(GFCI) <input type="checkbox"/>	<b>Frequency High Loss Level_1(Hz)</b> 0
<b>Digital meter modbus address</b> 200	Terminal Resistor <input type="checkbox"/>	<b>Frequency Low loss Level_1(Hz)</b> 0
<b>Maximum feed in grid power(W)</b> 70000	Derated Power(%) 0	<b>Voltage High Loss Level_1(V)</b> 0
	Power Factor 0.00	<b>Voltage Low Loss Level_1(V)</b> 0
	Insulation Impedance(kΩ)	<b>Frequency High Loss Time Level_1(ms)</b> 0
	Leakage Current Point(mA)	<b>Frequency Low loss Time Level_1(ms)</b> 0
	Unbalanced Voltage Point(%)	<b>Voltage High Loss Time Level_1(ms)</b> 0
	Moving Average Voltage Limit(V) 0	<b>Voltage Low Loss Time Level_1(ms)</b> 0
		<b>Frequency High Loss Level_2(Hz)</b> 0
		<b>Voltage High Loss Level_2(V)</b> 0
		<b>Frequency High Loss Time Level_2(ms)</b> 0
		<b>Voltage High Loss Time Level_2(ms)</b> 0

## Controlul puterii reactive

Mergeti la Console> Reactive Power Control, in veti putea seta parametrii pentru controlul puterii reactive.

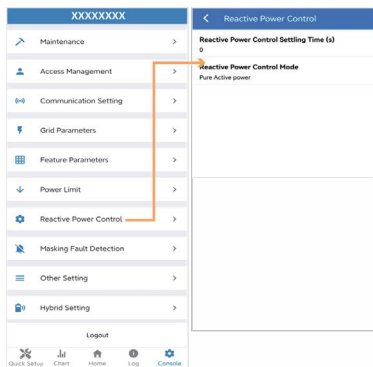

## Alter setari

Mergeti la Console> Other Setting, aici veti putea seta parametrii diversi.

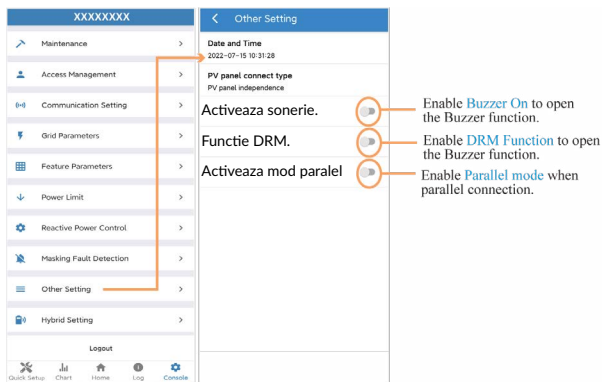

## Setari pentru functionalitate hibrid

Mergeti la Console>Hybrid Setting, aici veti putea seta parametrii specifici.

The image shows a two-panel interface. The left panel is a navigation menu with a header 'XXXXXXXX' and a footer with icons for 'Quick Set...', 'Chart', 'Home', 'Log', and 'Console'. The menu items are: Maintenance, Access Management, Communication Setting, Grid Parameters, Feature Parameters, Power Limit, Reactive Power Control, Masking Fault Detection, Other Setting, and Hybrid Setting. An orange arrow points to the 'Hybrid Setting' item. The right panel is titled 'Hybrid Setting' and contains the following configuration options:

- Hybrid work mode: Self used mode
- Battery type selection: Unavailable
- Maximum charger power(W): 0
- Capacity of charger end(%): 0
- Maximum discharger power(W): 555
- Capacity of discharger end(%): 0
- EPS Output:
- Rated output voltage(V): 220V
- Off-grid start-up battery capacity(%): 0
- Support Normal Load:
- Force Charge Start Capacity of charger Start(SOC %): 10
- Force Charge End Capacity of charger End(SOC %): 15

**ATENȚIONARE**

Înainte de verificare și punerea în funcțiune a invertorului împreună cu sistemul periferic de distribuție, închideți toate terminalele sub tensiune ale invertorului și așteptați cel puțin 10 minute după oprirea lui.

**8.1 Mentenanța de rutină**

Componente	Verificați conținut	Acțiune de întreprins	Interval de mentenanță
Stare ieșire invertor	Tineți sub observație randamentul electric și monitorizați de la distanță comportamente atipice	N/A	Săptămânal
Curățare invertor	Verificați ca ventilația invertorului să fie eliberată de praf sau alte bariere	Curățați ventilația frecvent	Anual
Starea de funcționare a invertorului	Verificați ca invertorul să nu fie deteriorat sau deformat Verificați sunetele emise de invertor în timpul funcționării. Asigurați-vă că legăturile de comunicație cu invertorul funcționează.	Dacă se observă comportamente atipice, înlocuiți componentele relevante.	Lunar
Conexiunile electrice ale invertorului	Asigurați-vă ca toate cablurile (CC, CA și cele de comunicare) sunt corect conectate. Asigurați-vă că PGND este corect conectat. Verificați ca toate cablurile să fie în stare bună.	Dacă există comportamente atipice, înlocuiți cablul sau reatașiți-l.	De 2 ori pe an

## 8.2 Depanare invertor

Cod	Informatie alarma	Sugestii
A0	Retea supra-tensiune	<ol style="list-style-type: none"><li>1. Daca alarma se declanseaza ocazional, e posibil ca reseaua sa fi fost temporar afectata si nu este necesara nicio actiune.</li><li>2. Daca alarma se declanseaza in mod repetat, contactati furnizorul local de energie pentru a cere aprobare de a face schimbari la parametrii de protectie setati.</li><li>3. Daca alarma persista, verificati daca siguranta de circuit CA este sarita sau daca reseaua are o perioada de inactivitate.</li></ol>
A1	Retea sub-tensiune	
A3	Retea supra-frecventa	
A4	Retea sub-frecventa	
A2	Lipsa retea	Asteptati pana reseaua este restabilita.
B0	Panouri fotovoltaice supra-tensiune	Verificati ca tensiunea de pe un singur sir de panouri nu depaseste pragul critic. Daca tensiunea depaseste pragul acceptat, modificati numarul de panouri conectate.
B1	Panouri fotovoltaice izolare atipica	<ol style="list-style-type: none"><li>1. Verificati rezistenta la izolare la impantare a panourilor PV. Daca exista scurtcircuit, rectificati eroarea.</li><li>2. Daca rezistenta la izolare la impantare este mai mica decat valoarea implicita intr-o zi ploioasa, setati protectia la rezistenta de izolare din aplicatie.</li></ol>
B2	Curent de scurgere atipic	<ol style="list-style-type: none"><li>1. Daca alarma se declanseaza ocazional, invertorul se va redresa fara interventie.</li><li>2. Daca alarma se declanseaza frecvent, contactati Suportul Tehnic.</li></ol>



B4	Panouri fotovoltaice sub-tensiune	<ol style="list-style-type: none"> <li>1. Daca alarma se declanseaza ocazional, este posibil ca circuitele exterioare sa aibe un comportament atipic, care nu necesita interventie.</li> <li>2. Daca alarma se declanseaza frecvent sau perioade lungi de timp, verificati daca rezistenta la izolarea la impamantare a panourilor PV este prea mica.</li> </ol>
C0	Alimentare interna atipica	<ol style="list-style-type: none"> <li>1. Daca alarma se declanseaza ocazional, nu necesita interventie</li> <li>2. Daca alarma se declanseaza frecvent, contactati Suportul Tehnic.</li> </ol>
C2	Valoare mare a curentului DC-polarizare	<ol style="list-style-type: none"> <li>1. Daca alarma se declanseaza ocazional, nu necesita interventie.</li> <li>2. Daca alarma se declanseaza frecvent, si inverterul nu genereaza curent, contactati Suportul tehnic</li> </ol>
C3	Releu inverter atipic	<ol style="list-style-type: none"> <li>1. Daca alarma se declanseaza ocazional, nu necesita interventie.</li> <li>2. Daca alarma se declanseaza in mod repetat, revedeti referinta pentru retea supra tensionata. Daca inverterul nu genereaza curent, contactati Suportul Tehnic. Daca nu exista probleme la retea, se pot face verificari ale echipamentului. Daca deschideti capacul inverterului si se identifica deteriorari se poate trage concluzia ca echipamentul este defect. Contactati Suportul Tehnic.</li> </ol>
CN	Oprire de la distanta	<ol style="list-style-type: none"> <li>1. Oprirea manuala a fost facuta in aplicatie.</li> <li>2. Programul de monitorizare a comandat inchiderea sistemului.</li> <li>3. Indepartati modulul de comunicare si confirmati daca alarma se opreste. In cazul asta, inlocuiti modulul. In caz contrar, contactati Suportul Tehnic</li> </ol>

C5	Invertor supraincalzire	<p>1. Daca alarma se declanseaza ocazional, nu necesita interventie.</p> <p>2. Daca alarma se declanseaza in mod frecvent, verificati locul de instalare sa nu fie in bataia directa a soarelui, ventilatia este corecta, temperatura ambientala este in parametrii acceptati (de exemplu cum este in cazul in care invertorul este instalat pe un perete). Daca temperatura ambientala este sub 45 de grade si disiparea este eficienta, contactati Suportul Tehnic.</p>
C6	GPCI atipic	<p>1. Daca alarma se declanseaza ocazional, nu necesita interventie.</p> <p>2. Daca alarma se declanseaza frecvent, contactati Suportul Tehnic.</p>
B7	Sir panouri inversate	Verificati polaritatea sirului de panouri
C8	Ventilator atipic	<p>1. Daca alarma se declanseaza rar, reporniti invertorul.</p> <p>2. Daca alarma se declanseaza frecvent, verificati ca ventilatorul sa nu fie blocat de obiecte straine. Daca nu este cazul, contactati Suportul Tehnic.</p>
C9	Dezechilibru tensiune dc-link	<p>1. Daca alarma se declanseaza ocazional, nu necesita interventie.</p> <p>2. Daca alarma se declanseaza frecvent, invertorul nu functioneaza corect. Contactati Suportul Tehnic.</p>
CA	Dc-link supra-tensiune	
CB	Eraore comunicare interna	<p>1. Daca alarma se declanseaza ocazional, nu necesita interventie.</p> <p>2. Daca alarma se declanseaza frecvent, invertorul nu functioneaza corect. Contactati Suportul Tehnic.</p>
CC	Incompatibilitate software	<p>1. Daca alarma se declanseaza ocazional, nu necesita interventie.</p> <p>2. Daca alarma se declanseaza frecvent, invertorul nu functioneaza corect. Contactati Suportul Tehnic.</p>

CD	Eroare stocare internă	<ol style="list-style-type: none"> <li>1. Dacă alarma se declanșează ocazional, nu necesită intervenție.</li> <li>2. Dacă alarma se declanșează frecvent, invertorul nu funcționează corect. Contactați Suportul Tehnic.</li> </ol>
CE	Date inconsecvente	<ol style="list-style-type: none"> <li>1. Dacă alarma se declanșează ocazional, nu necesită intervenție.</li> <li>2. Dacă alarma se declanșează frecvent, invertorul nu funcționează corect. Contactați Suportul Tehnic.</li> </ol>
CF	Invertor atipic	<ol style="list-style-type: none"> <li>1. Dacă alarma se declanșează ocazional, nu necesită intervenție.</li> <li>2. Dacă alarma se declanșează frecvent, invertorul nu funcționează corect. Contactați Suportul Tehnic.</li> </ol>
CG	Boost atipic	<ol style="list-style-type: none"> <li>1. Dacă alarma se declanșează ocazional, nu necesită intervenție.</li> <li>2. Dacă alarma se declanșează frecvent, invertorul nu funcționează corect. Contactați Suportul Tehnic.</li> </ol>
CJ	Lipsa meter	<ol style="list-style-type: none"> <li>1. Verificați setările acestui parametru.</li> <li>2. Local APP-verificați dacă adresa de comunicare este în concordanță cu adresa contorului de energie electrică.</li> <li>3. Firul de comunicare este atașat incorect sau nu are contact.</li> <li>4. Contorul de electricitate este stricat.</li> <li>5. Dacă nu este nicio opțiune de mai sus, contactați Suportul Tehnic.</li> </ol>
P1	Avertisment Parallel ID	Verificați cablul de conectare în paralel și verificați dacă invertorul este online. Închideți toate invertoarele, verificați conectarea apoi porniți-le pe toate și verificați dacă alarma s-a oprit.
P2	Avertisment semnal paralel SYN	Semnalul de sincronizare în paralele este slab. Verificați dacă cablul de conectare în paralel este atașat corect.
P3	BAT paralel atipic	Bateria paralel funcționează atipic. Verificați dacă bateria invertorului raportează tensiune scăzută sau nu este conectată.

P4	GRID paralel atipic	Grid paralel functioneaza atipic. Verificati daca retea prezinta erori.
D2	Baterie supra tensionata	<ol style="list-style-type: none"> <li>1. Daca alarma se declanseaza ocazional, nu necesita interventie.</li> <li>2. Verificati daca protectia la supra tensiune a bateriei este montata corect.</li> <li>3. Bateria se comporta atipic.</li> <li>4. In cazul in care nu e nicio varianta anterioara, contactati Suportul Tehnic.</li> </ol>
D3	Baterie sub tensionata	<ol style="list-style-type: none"> <li>1. Daca alarma se declanseaza ocazional, nu necesita interventie.</li> <li>2. Verificati calea de comunicatie dintre inverter si BMS (doar la baterii Litiu).</li> <li>3. Bateria este slaba iar tensiunea nu atinge parametrii de functionare si este cu valoare mai mica decat SOC.</li> <li>4. Protectia la sub tensiune a bateriei este setata incorect.</li> <li>5. Bateria cu comportament atipic.</li> <li>6. In cazul in care nu e nicio varianta anterioara, contactati Suportul Tehnic.</li> </ol>
D4	Supracurent de descarcare a bateriei	<ol style="list-style-type: none"> <li>1. Verificati daca parametrii bateriei sunt setati corect.</li> <li>2. Bateria sub tensiune.</li> <li>3. Verificati daca o alta baterie separata este incarcata, iar curentul de descarcare depaseste specificatiile bateriei.</li> <li>4. Bateria cu comportament atipic.</li> <li>5. In cazul in care nu e valabila nicio varianta anterioara, contactati Suportul Tehnic.</li> </ol>
D5	Baterie temperatura ridicata	<ol style="list-style-type: none"> <li>1. Daca alarma se declanseaza frecvent, va rugam verificati locatia de instalare sa nu fie in bataia directa a soarelui sau temperatura ambientală sa nu depaseasca parametru maxim acceptat (cum ar fi într-o camera închisă).</li> </ol>
D6	Baterie temperatura prea joasa	<ol style="list-style-type: none"> <li>2. Daca bateria are un comportament atipic, inlocuiti bateria.</li> <li>3. In cazul in care nu e valabila nicio varianta anterioara, contactati Suportul Tehnic.</li> </ol>

D7	Tensiune iesire EPS atipic	<ol style="list-style-type: none"> <li>1. Verificati daca tensiunea si frecventa sunt in parametrii de siguranta.</li> <li>2. Verificati ca portul EPS sa nu fie supraincarcat.</li> <li>3. Cand nu este conectat la retea, verificati daca iesirea EPS este in parametri normali.</li> <li>4. In cazul in care nu e valabila nicio varianta anterioara, contactati Suportul Tehnic.</li> </ol>
D8	Eroare de comunicare (Invertor-BMS)	<ol style="list-style-type: none"> <li>1. Verificati daca bateria este deconectata.</li> <li>2. Verificati daca bateria este conectata la invertor.</li> <li>3. Verificati daca bateria este compatibila cu invertorul. Folositi comunicare CAN.</li> <li>4. Verificati daca cablul sau portul de comunicare dintre baterie si invertor este defect.</li> <li>5. In cazul in care nu e valabila nicio varianta anterioara, contactati Suportul Tehnic.</li> </ol>
D9	Lipsa comunicatie interna (E-M)	<ol style="list-style-type: none"> <li>1. Verificati daca cablul de comunicare dintre EPS, contorul meter si invertor sunt conectate corect.</li> <li>2. Verificari daca distanta este in parametrii.</li> <li>3. Deconectati comunicarea externa si reconectati contorul electric si invertorul.</li> <li>4. In cazul in care nu e valabila nicio varianta anterioara, contactati Suportul Tehnic.</li> </ol>
DA	Lipsa comunicatie interna (M-D)	
CU	Dc-dc atipic	<ol style="list-style-type: none"> <li>1. Daca alarma se declanseaza ocazional, nu necesita interventie.</li> <li>2. Daca alarma se declanseaza in mod repetat va rugam verificati: daca terminalul MC4 al invertorului este conectat corect. Verificati daca tensiunea la invertor este in circuit deschis, scurtcircuit etc In cazul in care nu e valabila nicio varianta anterioara, contactati Suportul Tehnic.</li> </ol>
CP	EPS scurtcircuit	<ol style="list-style-type: none"> <li>1. Verificati daca nu exista un scurt circuit intre nul si faza la iesirea EPS.</li> <li>2. Daca nu este un scurtcircuit contactati Suportul Tehnic. (dupa depanare, intreruptorul EPS trebuie pornit manual.</li> </ol>

DB	EPS scurtcircuit	<ol style="list-style-type: none"> <li>1. Verificati daca nu exista un scurtcircuit intre nul si faza la iesirea EPS.</li> <li>2. Daca nu este un scurtcircuit contactati Suportul Tehnic. (dupa depanare, intreruptorul EPS trebuie pornit manual).</li> </ol>
DC	EPS supraincarcare	<ol style="list-style-type: none"> <li>1. Deconectati incarcarea EPS si observati daca alarma s-a oprit.</li> <li>2. Daca ati executat aceasta operatiuni si alarma persista va rugam contactati Suportul Tehnic. Dupa depanare, intreruptorul EPS trebuie pornit manual)</li> </ol>

### 8.3 Dezinstalarea invertorului



#### AVERTISMENT

Inainte de a indeparta conectorul de intrare DC, verificati ca siguranta DC sa fie pe pozitia OFF pentru a evita distrugerii si raniri grave.

Pentru a inlatura invertorul urmati procedura:

**Pasul 1.** Deconectati toate cablurile de la invertor, cabluri de comunicare, cabluri intrare DC, cablu iesire AC, cablu PGND cum este prezentat mai jos.

#### NOTIFICARE!

*Pentru a indeparta conectorii PV/GRID/EPS inserati unealta de indepartare in montura de tip baioneta cum este prezentata in schema, apasati spre interior si scoateti conectorul spre exterior*

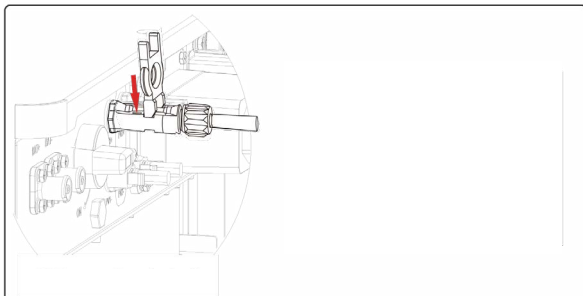

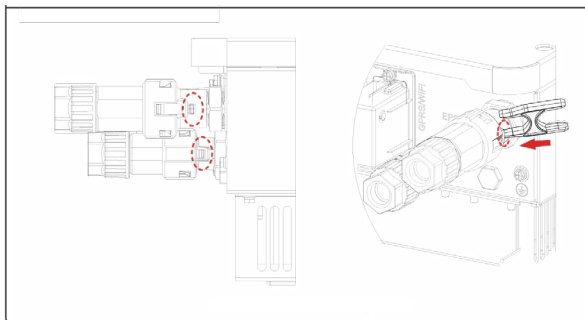

**Pasul 2.** Indepartati invertorul din brachetii de montare.

**Pasul 3.** Indepartati brachetii de pe perete.



### **Dezafectarea echipamentelor electrice si electronice vechi**

*(Se aplica pentru țările membre ale Uniunii Europene si pentru alte țări europene cu sisteme de colectare separata)*

Acest simbol aplicat pe produs sau pe ambalajul acestuia indica faptul ca acest produs nu trebuie tratat ca pe un deșeu menajer.

El trebuie predat punctelor de reciclare a echipamentelor electrice si electronice.

Asigurandu-va ca acest produs este dezafectat in mod corect, veți ajuta la prevenirea posibilelor consecințe negative asupra mediului si a sănătății umane, care ar fi putut surveni daca produsul ar fi fost dezafectat in mod necorespunzător.

Reciclarea materialelor va ajuta la conservarea resurselor naturale.





## Memo

A series of horizontal dotted lines for writing, spanning the width of the page below the header.



## Memo

A series of horizontal dotted lines for writing, spanning the width of the page below the header.



## Memo

A series of horizontal dotted lines for writing, spanning the width of the page below the header.

