

Product Summary

The OSMV 210/611/712 Outdoor Streaming Motion Viewer is a wireless, battery operated, motion activated or electrically activated outdoor camera designed for use in Videofied® security systems.

- Powered by 4 Lithium batteries for extended battery life.
- 90° multi-purpose lens (by default).
- Provided optional lenses: curtain, pet-immune or long range beam.
- 4 infrared LEDs for 12m night vision.
- Standard detection distance (up to 14 meters).
- Fully weatherproof (IP54) and temperature resistant (-25°C/+70°C).
- Wall, cover and movement tamper triggered by tilt sensor.
- Transmits check-in/status signal every 8 minutes.
- 3 wired programmable inputs.
- 1 wired programmable output triggered on detection.
- Video capture and transmission in «streaming mode» on user request.



Installation Guidelines

For easier installation, programming and RF testing should be done to check for good communication between the control panel and all system devices before mounting system devices.

Install the detector and other system devices in the order of the following steps:

- > Programming/RF Testing - program detector and all other devices into the control panel and test RF communication from each intended device location to the control panel.
- > Mounting - mount detector at the tested location.

Mounting

- > Use proper tools and hardware.
- > Mount camera between 2.5 m to 3,5 m height.
- > The OSMV MotionViewer detection distance may vary depending on mounting (height, tilt). The OSMV is not suitable to protect an area, it needs to be used to protect an access point or any property.
- > Mount detector aimed toward the spot to protect.
- > In order to reduce false alarms, do not aim the detector toward vegetation, a road, or unlimited space.
- > Do not cover the Fresnel lens. Use only the provided masking kit to block detection towards specific spots (trees, bushes, etc.).

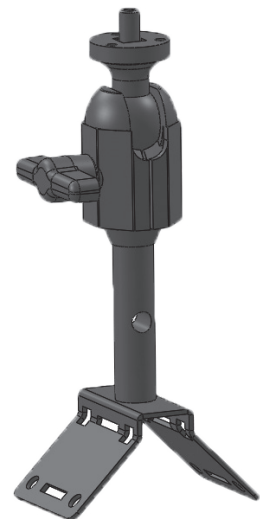

*MB110 Mounting kit for
Outdoor MotionViewer*

Programming/RF Testing/Mounting

The following provides summarized steps for device programming, testing, and mounting. For complete details, refer to the control panel installation manual.

1 Separate the base from the box

2 Install 4 3.6V LS14500 SAFT batteries observing correct polarity.

3 Put control panel into Programming/Configuration mode.

4 Using a programmed alphanumeric keypad, proceed through menus until the display shows ADD A NEW DEVICE.

5 Press OK/YES. the display shows PRESS PROGRAM BUTTON OF DEVICE.

6 Press and release program button on the OSMV MotionViewer.

The OSMV PIR flashes.

7 Wait for keypad display to show CAMERA(1 - 25) PROGRAMMED. Press OK/YES, the display shows RADIO RANGE TEST? Press OK/YES again. The camera LED starts flashing and keypad display shows RF TEST.

8 Take the OSMV camera to its intended mounting location and make sure LED flashes continuously or you receive a 9/9 indicating good communication with the control panel.



9 Press OK/YES to end radio range test then press ESC/NO.

10 The keypad displays :

AREA ALLOCATION :

AREA : 1

Press either arrow button repeatedly until desired area number appears then press OK/YES. By default all devices in Area 1 are automatically delayed.

11 The display shows NAME + LOCATION:

Enter appropriate device name/location (up to 16 characters), then press OK/YES. The display shows the device number and name for your verification.

12 Mount the OSMV on the MB110 or MBW110 Mounting kit. Follow the installation guidelines shown in this document.

13 Press OK/YES. The display shows FUNCTIONAL DEVICE TEST? Press OK/YES and verify camera operation. The activation of the LED will determine the detection field.

14 Press OK/YES to end detection verification.

15 The display shows OPERATION COMPLETED or ADD A NEW DEVICE? Press YES/OK. Repeat steps 1 – 14 for remaining cameras.

16 When finished, exit from configuration mode.



OSMV MotionViewer reset

To clear the OSMV memory in order to pair it with a new panel programming, please follow the procedure below :

1. Remove the batteries from the OSMV.
2. Leave the battery case empty for about 30 seconds.
3. Reinsert the batteries inside the OSMV.
4. Follow the programming procedure described above from bullet point 3.

Mounting Recommendations

Please direct the OSMV towards the **access point** or the **asset** you need to protect. The detector should not be mounted close or above an access point. Such installation increase the probability of a missed intrusion.

For optimal use, OSMV MotionViewer mounting shall respect the following recommendations:

Mounting height :

RSI Video Technologies recommends a **2,5 m to 3,5 m** mounting height.

When you install the MotionViewer higher, **the detection distance is raised**. However the sensitivity is reduced and the blind area under the MotionViewer is larger.

When you install the MotionViewer lower, **the sensitivity is raised** and the blind area under the detector is reduced. However the detection distance will be reduced.

Tilt :

Raising or reducing the tilt, even slightly, has a big impact on the detection distance and on the blind area under the MotionViewer. We recommend to slightly tilt the OSMV to **reduce its detection range** and avoid **false alarms**.

To precisely determine the tilt angle use a smartphone app like *Smart Protactor (Android)* or *Pitch Gauge (iOs)*.

Max detection distance : MULTI-PURPOSE 90° LENS		Tilt angle				
		5°	10°	15°	20°	30°
Mounting height	2.5 m	12m	9m	7m	6m	
	2.75 m	13m	9m	7,5m	6m	
	3 m	14m	10m	8m	7m	5m
	3.25 m	14m*	11m	9m	7m	5m
	3.5 m	14m*	12m	9m	8m	5,5m

Theoretical values estimated for default sensitivity.

These values only represent the physical limits of the OSMV detection and not its maximum detection range. Long range sensitivity is reduced and depends on infrared detection properties (see page 5).

** In some cases, false alarms can be triggered from outside the 14m detection limit (street, bushes, trees, etc). If that happens, please slightly tilt the OSMV downward to prevent false alarms.*

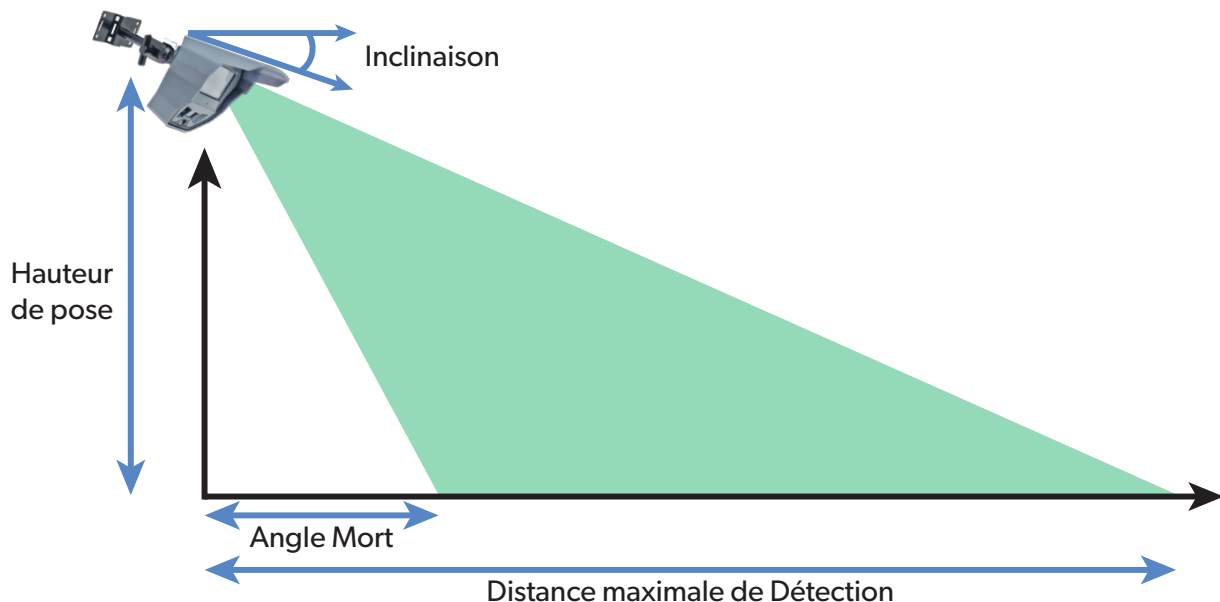

Tilt Tamper

The OSMV MotionViewer can detect manipulation thanks to its built-in electronic accelerometer.

This device can detect shocks, movements, wall or cover tamper but also changes in its orientation.

When a movement of the OSMV is detected, the LED lights up for 3 seconds.

When it is armed for the first time, the OSMV registers its position in space. If its orientation is significantly changed on its transverse or longitudinal axis, a tamper alarm is sent to the panel. As for every Videofied device, the tamper is active 24/7.

If the detector is moved, **the TAMPER notification will be displayed on the keypad the next time the system is armed. Press OK/YES to acknowledge that notification and confirm the detector new position.** If the TAMPER event is set as ALARM/END, a tamper restoral event is sent to the panel.



Tilt tamper disabling (only for OSMV version 07.06.04.XX and later)

Tamper disabling

The OSMV Motionviewer must be deleted from the panel memory to disable tamper.

1. Delete the OSMV from the device configuration menu.
2. Press and hold the OSMV initialization button for 5 seconds. The red LED will turn on for 2 seconds to confirm the setting.
3. Pair the OSMV back with your panel.

Tamper re-enabling

The tamper re-enabling procedure is the same

1. Delete the OSMV from the device configuration menu.
2. Press and hold the OSMV initialization button for 5 seconds. The red LED will turn on for 2 seconds to confirm the setting.
3. Press and hold the init button for 5 seconds. The red LED will turn on for 2 seconds, off for half a second and back on for 2 seconds.
4. Pair the OSMV back with your panel.

Wired inputs/output

The OSMV MotionViewer has 3 built-in wired inputs. With these inputs, other detection systems can be associated with the OSMV.

IN1 and IN2 inputs : Normally open wired inputs. These inputs are enabled when the OSMV is armed. When triggered, an INTRUSION event is sent to the panel and the OSMV captures a video.

IN3 input : Normally open wired input. This input is enabled 24/7. When triggered, a TAMPER event is sent to the panel.

The OSMV also has one built-in wired output. This output can activate a wired system when the OSMV infrared detection is triggered.

OUT output : 24 V/100mA open drain contact. When the OSMV is triggered, the output contact closes for 3 seconds and opens.

Inputs/outputs wiring

Two drilling punch marks are visible on the OSMV case. One under the case and one inside the box on the bottom right.

Drill a hole in one of these punch marks to pass the wire through and connect the inputs/outputs terminal.

IMPORTANT :

Once the wire is connected, protect the inside of the case with a silicone watertight seal.

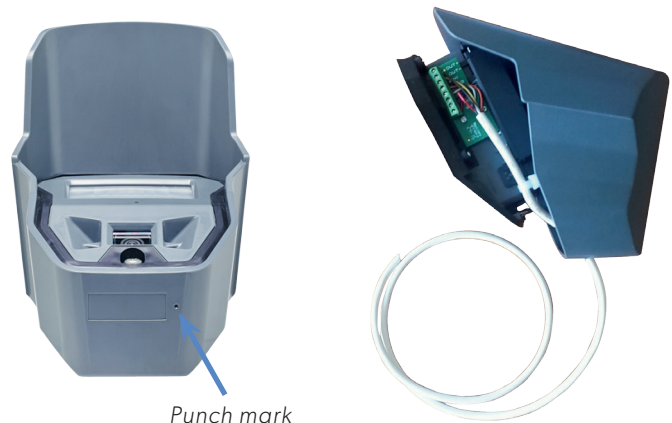

Infrared detection

The OSMV outdoor MotionViewer uses standard infrared detection. The PIR is optimized for the detection of individuals.

Several parameters affect the detection :

- Subject thermal signature (size, width, temperature and emissivity).
- Detection environment (ambient temperature, reflectivity of the surfaces, the presence of water or moist surfaces).
- Speed and direction of the movement.
- OSMV setup (tilt, height, lens type, sensitivity).

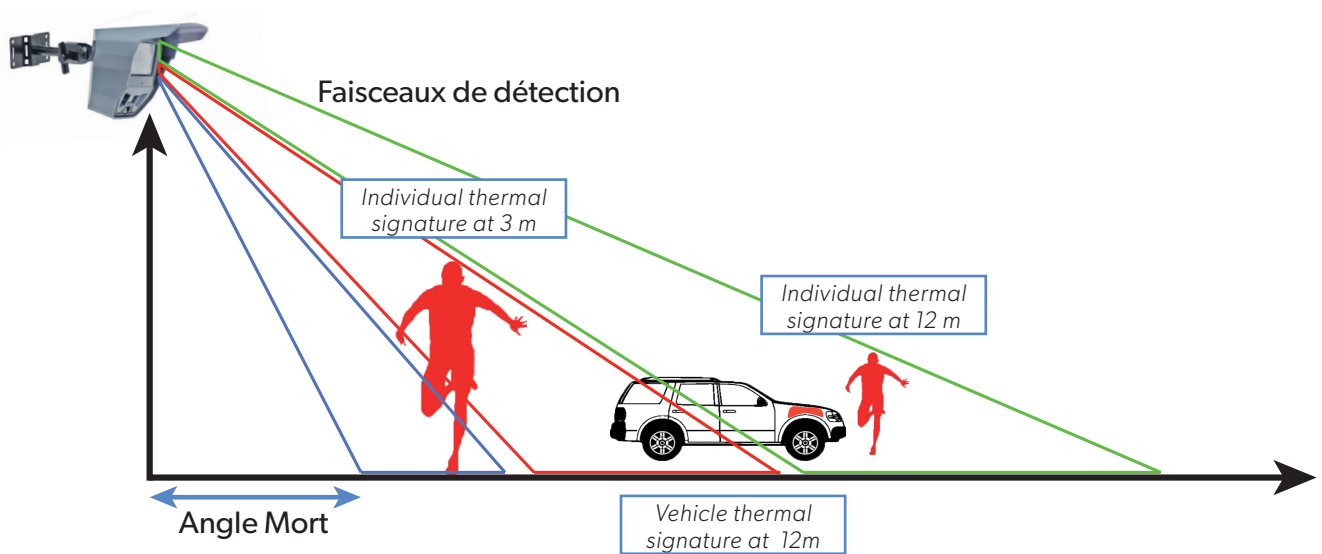

Important :

It is essential to monitor the proper functioning of the infrared detection using the FUNCTIONAL TEST feature in the panel MAINTENANCE menu.

A red status LED lights up when the OSMV is detecting. Use that test to determine the pattern of the detection field.

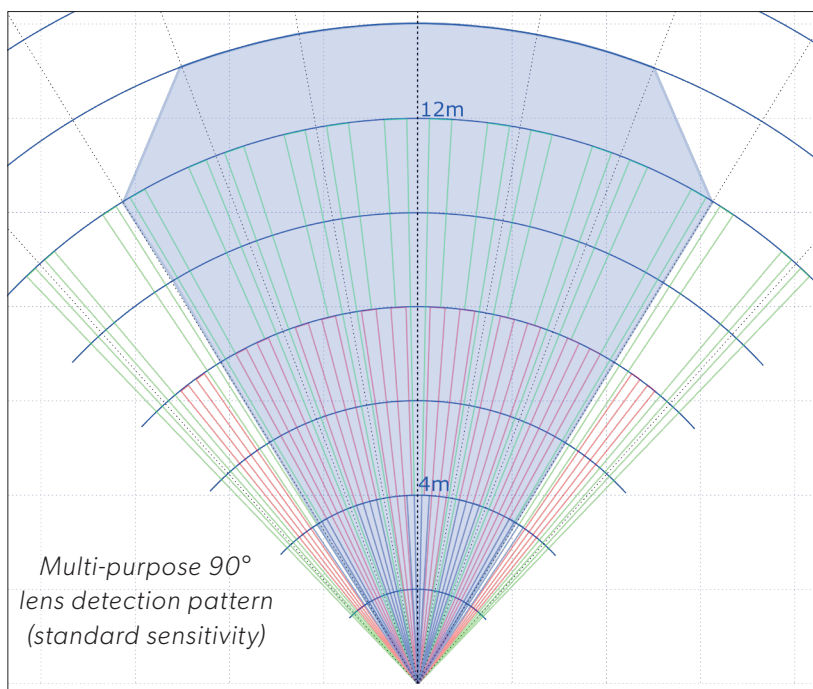

OSMV OUTDOOR STREAMING MOTION VIEWER

Optional lenses installation

The following steps describe the OSMV lens replacing procedure:

- 1 Carefully loosen the 4 screws of the lens frame. **Do not use an electric screwdriver.** This can damage the threads. Leave the screws on the threads in order not to lose them.
- 2 When the 4 screws are loose, push on each one with a screwdriver to remove the lens frame.
- 3 Remove the lens frame and the lens. Wipe the new lens with a soft dry cloth and install it. There is a fail-safe in the bottom right corner of the lens to ensure that the new lens is installed the right way round.
- 4 Replace the lens frame on the OSMV and gently tighten the screws using a mechanic screwdriver.
- 5 Replace the OSMV in its case, tighten the screw and install on site.
- 6 Adjust the PIR sensitivity according to the lens in the configuration menu (see below).
- 7 It is essential to monitor the proper functioning of the infrared detection using the FUNCTIONAL TEST feature in the panel MAINTENANCE menu. A red status LED lights up when the OSMV is detecting. Use that test to determine the pattern of the detection field.

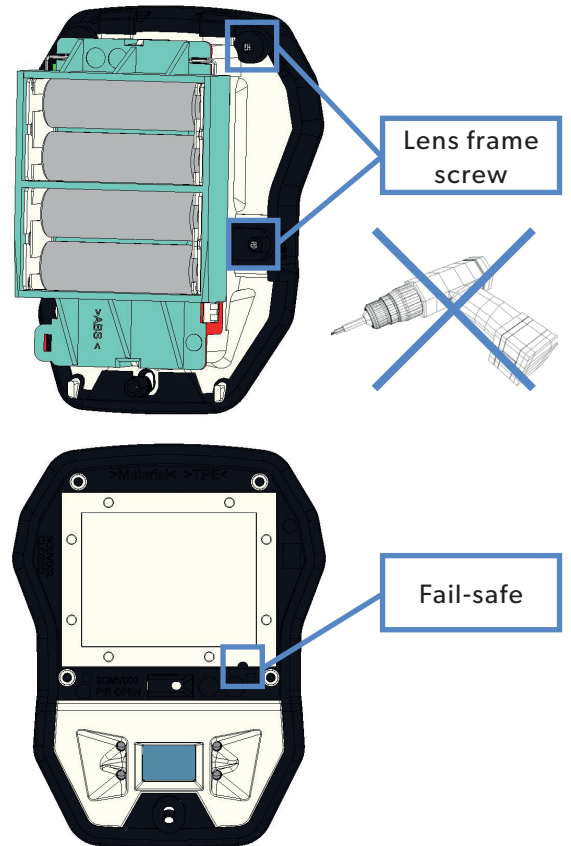

Adjust sensitivity to the optional lens

Curtain and beam lenses are more sensitive than the multipurpose lens, whereas pet-immune is less sensitive than multipurpose. Adjusting sensitivity to the lens type is mandatory. Use the \$ function.

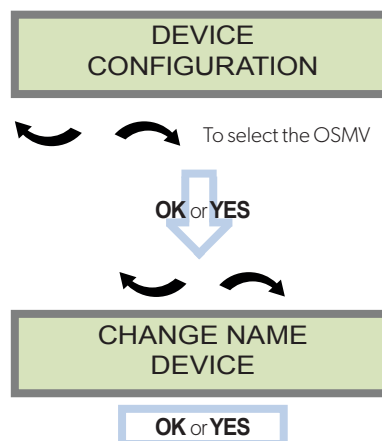

CURTAIN	detector_name\$1
PET-IMMUNE	detector_name\$8
BEAM	detector_name\$2

OSMV OUTDOOR STREAMING MOTION VIEWER

Optional lenses

The OSMV MotionViewer is provided with 3 optional lenses. With these lenses the detection can be adapted to the site environment.

Curtain lens (vertical)

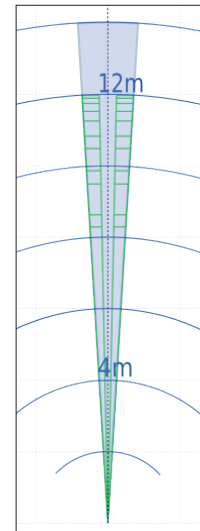
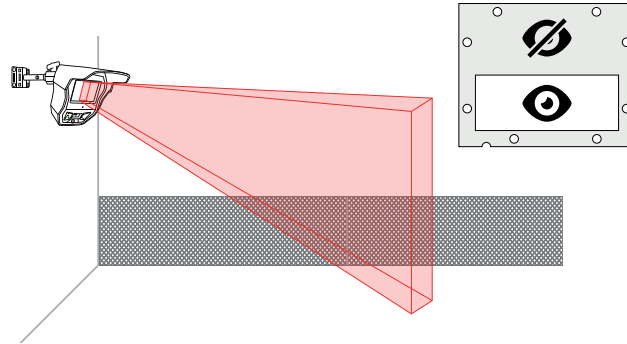
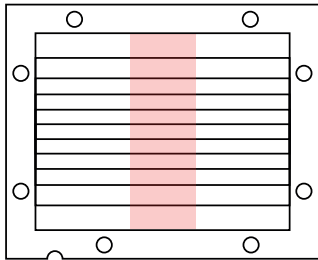

Max detection distance : CURTAIN LENS		Tilt angle				
		5°	10°	15°	20°	30°
Mounting height	2.5 m	14m*	11m	8m	6,5m	
	2.75 m	14m*	12m	9m	7m	5m
	3 m	14m*	13m	9,5m	7,5m	5,5m
	3.25 m		14m	10m	8m	5,5m
	3.5 m		14m*	11m	8,5m	6m

Pet-immune lens (horizontal curtain)

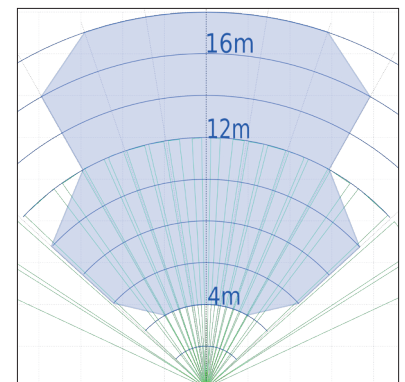
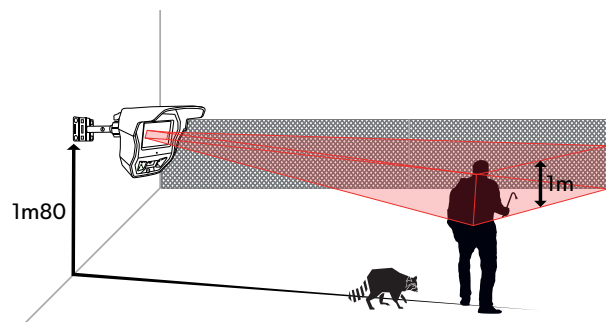
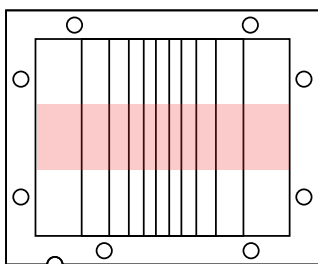

Long range beam lens

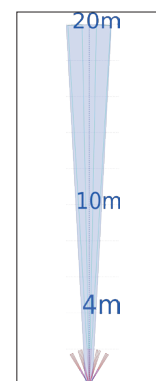
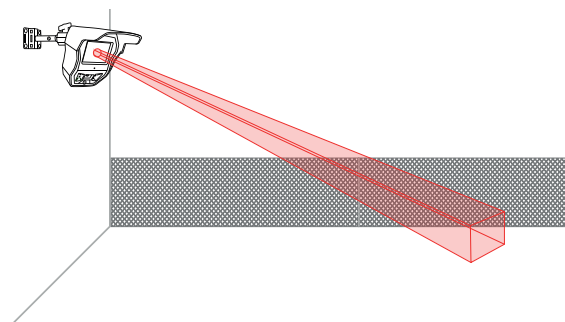
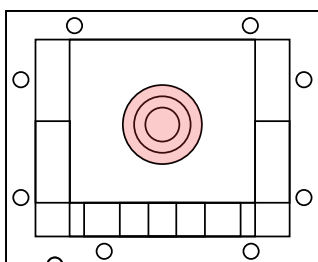

Sensitivity adjustment

The OSMV detector comes with the capability of adjusting the sensitivity level of the PIR. It can improve the detection or, on the contrary, reduce false alarms. Raising sensitivity will raise detection range, the detection field will be larger and smaller thermal signatures will be detected. You should only use this feature when the site has been diagnosed as needing this adjustment. It cannot be used to optimize detection as the adjustment may be too high and generate either false alarms or missed intrusions.

Examples : Plant growth, pets.

Please note that the detector must be installed to prevent intrusions (aim the detector towards an access point), sensitivity adjustment will have no effect if the installation doesn't comply with the installation recommendations described in this document.

Adjust sensitivity for the OSMV MotionViewer

To change the OSMV sensitivity, you need to change the **detector name**:

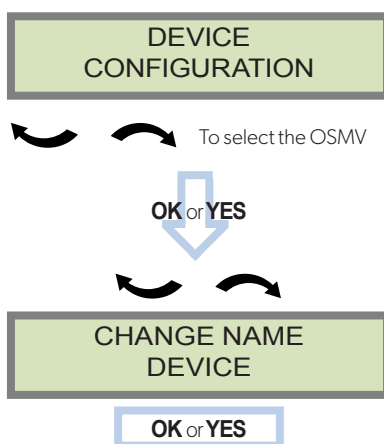

Enter the detector name then enter the \$ symbol at the end and the chosen digit (without space). The number following \$ will depend on the necessary adjustment:

	MULTI-PURPOSE 90°	CURTAIN	PET-IMMUNE	BEAM
MINIMAL SENSITIVITY	detector_name\$2		detector_name\$1	
LOW SENSITIVITY	detector_name\$1	detector_name\$2	detector_name\$0	
DEFAULT SENSITIVITY	detector_name	detector_name\$1	detector_name\$8	detector_name\$2
HIGH SENSITIVITY	detector_name\$8	detector_name\$0	detector_name\$9	detector_name\$0
MAXIMAL SENSITIVITY	detector_name\$9	detector_name\$8		detector_name\$8

\$ Symbol

CMA keypad : Press @ repeatedly until \$ is displayed

XMA/XMB keypad : Press 1 repeatedly until \$ is displayed

OSMV OUTDOOR STREAMING MOTION VIEWER

90° masking kit

The OMV MotionViewer is provided with a 90° masking kit (only compatible with the multi-purpose 90° lens).

With this kit you can inhibit specific zones in the detection field because elements in those zones can generate false alarms, like a tree or a road.

Detach the precut elements from the kit to only leave the zones that will be masked, as shown below. Use the lens replacing procedure shown previously and place the masking kit directly behind the 90° lens. Close the lens frame.

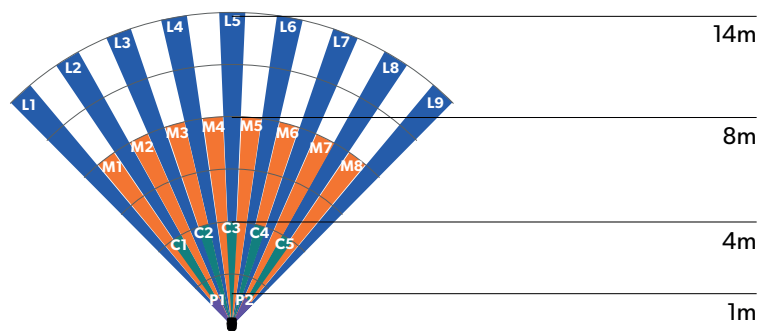
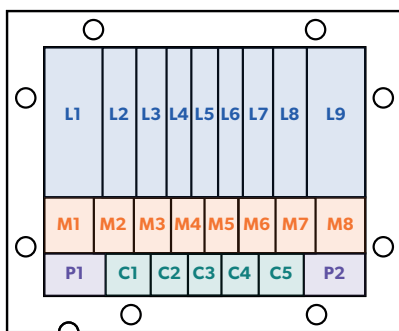
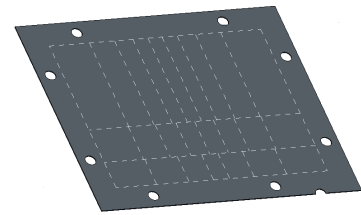

Curtain masking kit

A masking kit for curtain lens is provided as well.

Installing this kit is highly recommended for open air installations. As shown below, it will reduce false alarms.

Use the lens replacing procedure shown previously and place the masking kit behind the curtain lens.

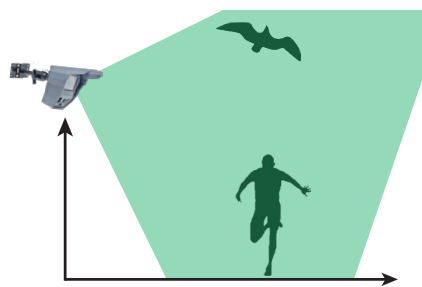
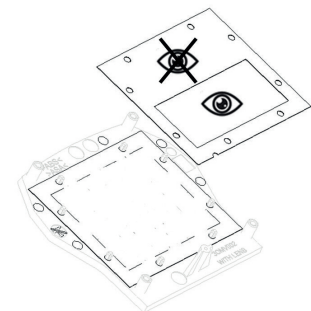

Curtain detection without masking kit

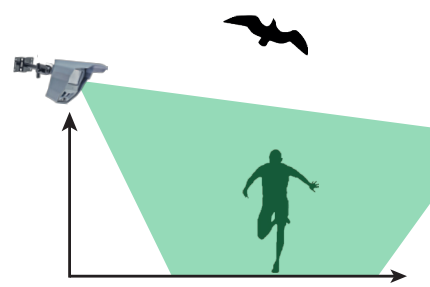

Curtain detection with masking kit

Streaming option

The new OSMV MotionViewer allow the user to request a live video session.

The OSMV is the first battery-powered wireless camera detector emitting on 868MHz able to provide a **live video stream from its camera.**

The 868 MHz frequency has excellent range and allow for excellent battery-life.

Security notes / (FR) Notes de sécurité / (DE) Hinweise zur Sicherheit

English

- Remove the batteries before any maintenance !
- **WARNING, there is a risk of explosion if a battery is replaced by an improper model !**
- Observe polarity when setting up the batteries!
- Do not litter the batteries when they are used! Dispose of them properly according to Lithium Metal requirements

Français

- Retirez les piles avant toute opération de maintenance !
- **Attention ! Il ya un risque d'explosion si la batterie utilisée est remplacée par un mauvais modèle !**
- Respectez la polarité lors de la mise en place des piles !
- Ne jetez pas les batteries usagées ! Ramenez-les à votre installateur ou à un point de collecte spécialisé.

Deutsch

- Batterien vor jeglichen Wartungsarbeiten entfernen!
- **Vorsicht, es besteht Explosionsgefahr, wenn eine Batterie durch eine Batterie falschen Modells ersetzt wird!**
- Achten Sie beim Einsetzen der Batterien auf die Polung!
- Entsorgen Sie Batterien nicht im normalen Haushaltsmüll! Bringen Sie Ihre verbrauchten Batterien zu den öffentlichen Sammelstellen.

FCC Regulatory Information for USA and CANADA

FCC Part 15.21 Changes or modifications made to this equipment not expressly approved by RSI Video Technologies may void the FCC authorization to operate this equipment.

FCC Part 15.105 Class B

This equipment has been tested and found to comply with the limits for a Class B digital device, pursuant to Part 15 of the FCC Rules. These limits are designed to provide reasonable protection against harmful interference in a residential installation. This equipment generates, uses and can radiate radio frequency energy and, if not installed and used in accordance with the instructions, may cause harmful interference to radio communications. However, there is no guarantee that interference will not occur in a particular installation. If this equipment does cause harmful interference to radio or television reception, which can be determined by turning the equipment off and on, the user is encouraged to try to correct the interference by one or more of the following measures:

- > Reorient or relocate the receiving antenna.
- > Increase the separation between the equipment and receiver.
- > Connect the equipment into an outlet on a circuit different from that to which the receiver is connected.
- > Consult the dealer or an experienced radio/TV technician for help.

Radio frequency radiation exposure information according 2.1091 / 2.1093 / OET bulletin 65

This equipment complies with FCC radiation exposure limits set forth for an uncontrolled environment. This equipment should be installed and operated with minimum distance of 20 cm between the radiator and your body.

Cet équipement est conforme aux limites d'exposition aux rayonnements IC établies pour un environnement non contrôlé.

Cet équipement doit être installé et utilisé avec un minimum de 20 cm de distance entre la source de rayonnement et votre corps.

This transmitter must not be co-located or operating in conjunction with any other antenna or transmitter.

This device complies with Part 15 of the FCC Rules and with Industry Canada licence-exempt RSS standard(s)

Operation is subject to the following two conditions:

- 1 This device may not cause harmful interference, and
- 2 This device must accept any interference received, including interference that may cause undesired operation.

Le présent appareil est conforme aux CNR d'Industrie Canada applicables aux appareils radio exempts de licence.

L'exploitation est autorisée aux deux conditions suivantes :

- 1 L'appareil ne doit pas produire de brouillage, et
- 2 L'utilisateur de l'appareil doit accepter tout brouillage radioélectrique subi, même si le brouillage est susceptible d'en compromettre le fonctionnement.

ELECTRICAL PROPERTIES

Panel compatibility	
Streaming option	W panels
Without streaming option	X and VISIO panels
Power requirements	
Type C - 4 Lithium batteries 3,6 V LS14500	
Battery life	
Standard usage (up to 5 videos per month)	4 years
High usage (about 30 videos per month)	2 years
Standby current consumption	130 μ A
Max current consumption	320 mA

RADIO PROPERTIES

RF S2View® technology	
Radio type	Spread spectrum bidirectionnal
Operating frequency	<ul style="list-style-type: none"> • 868MHz - OSMV 210 (Europe, Africa, Asia) • 915 MHz - OSMV 611 (USA, Canada, South America) • 920 MHz - OSMV 712 (Australia, South America)
Transmission security	AES encryption algorithm
Supervision	Radio, batteries, tamper, position
Radio antenna	Integrated

VIDEO PROPERTIES

Camera	
Angle	90°
Sensor type	CMOS
Lighted video	Programmable : Color or B&W
Night vision video	Black & white automatic infrared
Infrared illumination	Automatic with 4 IR LEDs
Infrared illumination distance	Up to 12m
Video	
Video format	H264 (MPEG if not available)
Framerate	5 images per second
Video resolution	QVGA (320x240)
Average video file size	220 ko
Snapshot	
Format	JPEG
Resolution	VGA (640x480)
Average snapshot file size	8 ko

DETECTION PROPERTIES

Infrared detection specifications	
Technology	Passive infrared DSP
Type	Dual element sensor
Detection lens	<ul style="list-style-type: none"> • 90° • 1 m wide curtain (vertical or pet-immune) • Long distance beam (up to 1m diameter)
Tamper detection	
Tilt	Position change, shock, wall and cover tamper

BOX

Physical properties	
Material	Polycarbonate UL94
Dimensions	130,5mm x 102,44mm x 141,5mm
Weight	261g (without batteries)
Environmental data	
Operating temperature	-25° / +70°C
Max. relative humidity	95%, without condensing
Protection marking	IP 54 / IK 06
Installation / Mounting	
Mounting height	2.5 m to 3.5 m
Mounting angle	5° to 10°
Mounting	Use mounting kit (sold separately)

STANDARDS AND CERTIFICATIONS



868MHz (OSMV 210)

Compliant with the annex IV of the R&TTE Directive 1999/5/EC



915MHz (OSMV 611)

USA FCC

Part 15C

Canada IC

RSS-247 Issue 1



920MHz (OSMV 712)

Australia C-Tick

AS/NZS4268



This symbol on the product or on its packaging indicates that this product should not be treated as household waste. It must be handed over to the applicable collection point for the recycling of electrical and electronic equipment. By ensuring this product is disposed of correctly, you will help prevent potential negative consequences for the environment and human health. The recycling of materials will help to conserve natural resources.

For more information about recycling of this product, please contact your local municipality, your waste disposal service or the company that installed the product.

EMEA SALES

23, avenue du Général Leclerc
 92340 BOURG-LA-REINE
 FRANCE
 E-Mail : emeasales@rsivideotech.com

North American Headquarters

1375 Willow Lake Blvd, Suite 103
 Vadnais Heights, MN 55110
 USA
 E-Mail : usasales@rsivideotech.com

The EC declaration of conformity of this product is available by flashing that QR code :

