

Quick Start Guide

ProFace X

Version: 1.0

Date: May 2019

1 Overview

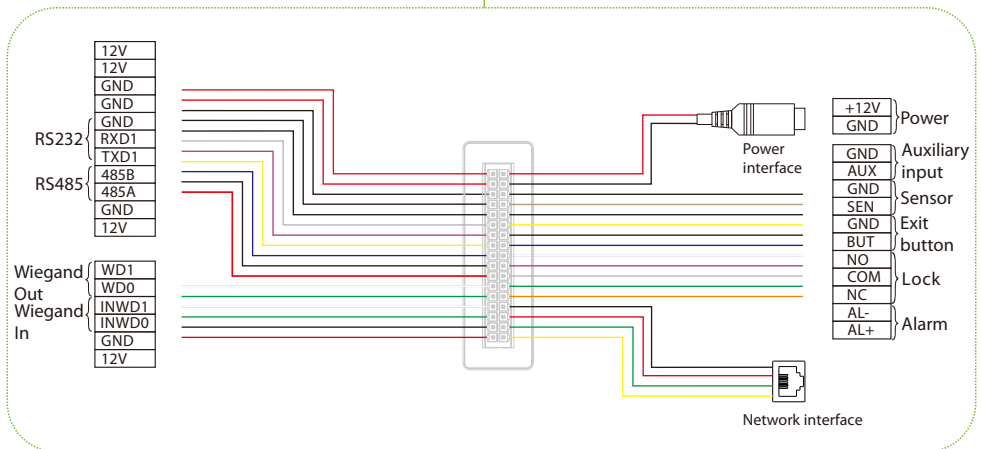
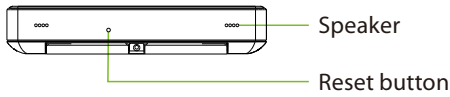
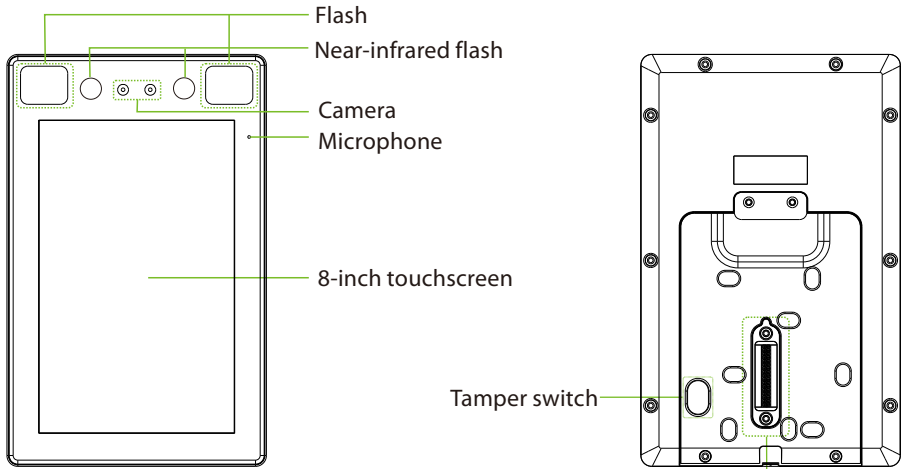

2 Device Installation

❖ Install on the wall

- ① Attach the mounting template sticker to the wall, and drill holes according to the mounting paper.
- ② Fix the back plate on the wall using wall mounting screws.
- ③ Attach the device to the back plate.
- ④ Fasten the device to the back plate with a security screw.

1

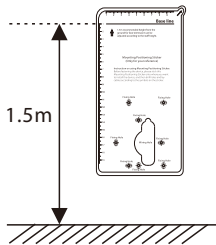

2

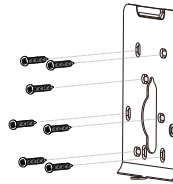

3

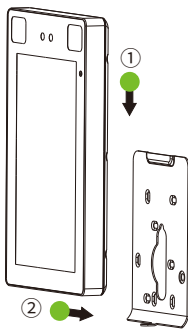

4

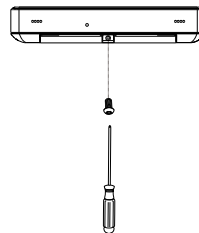

2 Device Installation

❖ Install on the barrier gate

Please thread the wire through the bracket before installation.

- ① Drill a hole on the barrier gate, insert the bracket into the hole and fix it with a nut.
- ② Adjust the angle of the device.

①

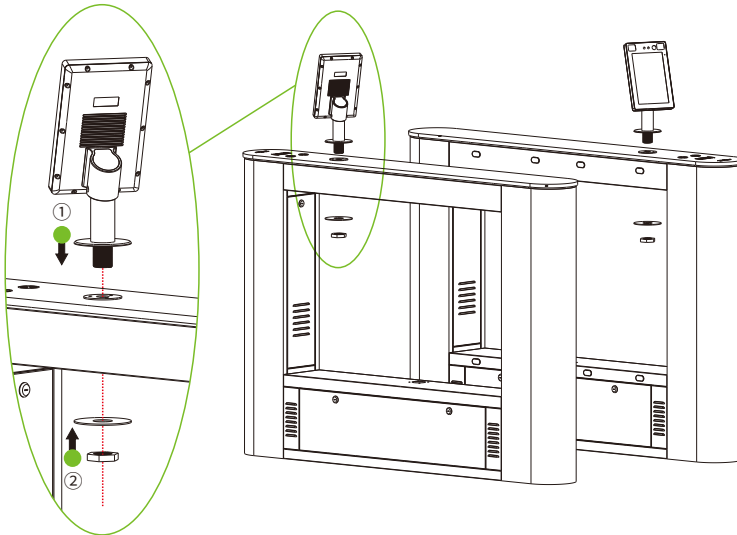

②

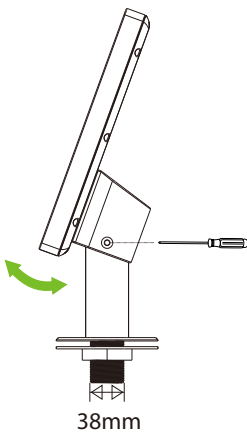

3 Standalone Installation

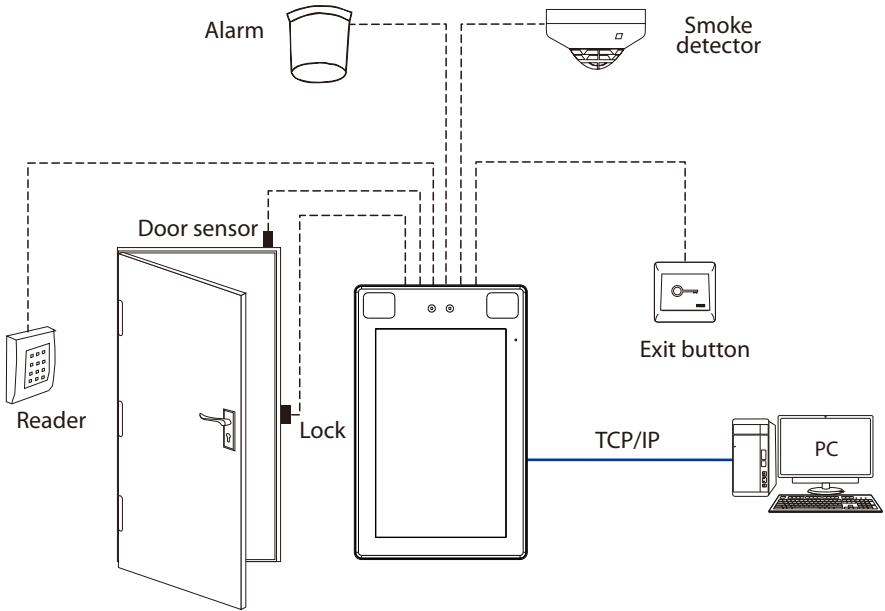

4 Door Sensor, Exit Button & Alarm Connection

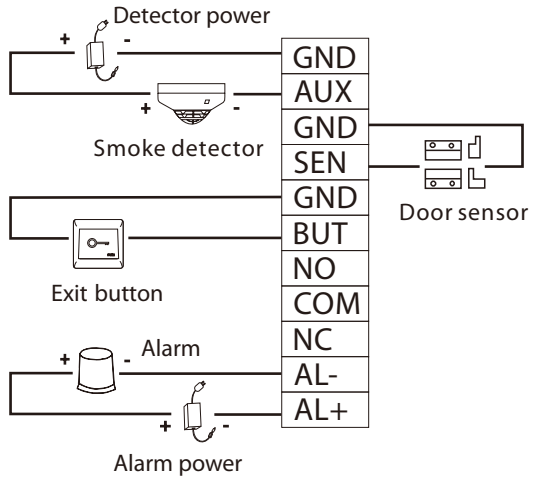
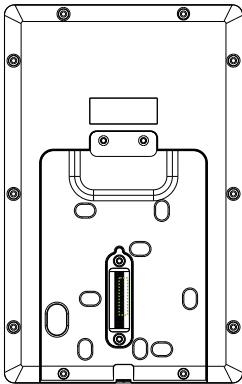

5 Lock Relay Connection

The system supports Normally Opened Lock and Normally Closed Lock.

The NO LOCK (normally unlocked when power-on) is connected with 'NO' and 'COM' terminals, and the NC LOCK (normally locked when power-on) is connected with 'NC' and 'COM' terminals. Take NC Lock as an example below:

1) Device not sharing power with the lock

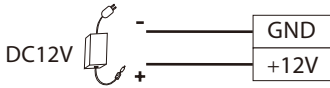

Maximum 30V 3A input.

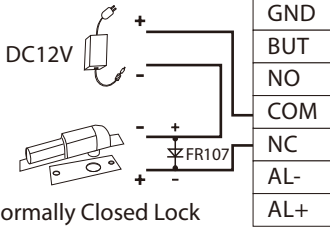

Do not reverse the polarity.

2) Device sharing power with the lock

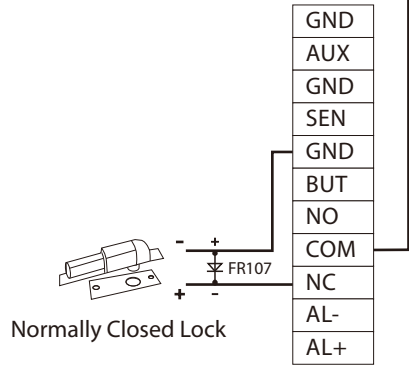
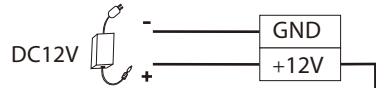

6 Wiegand Reader Connection

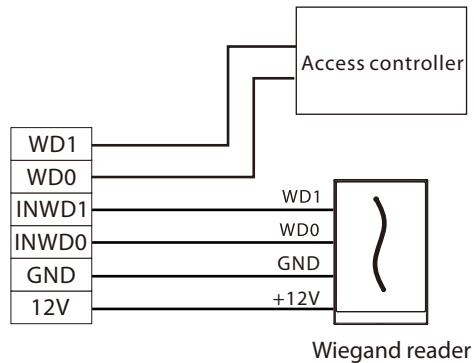
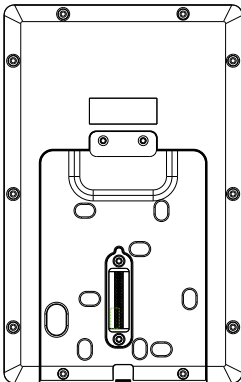

7 Barrier Connection

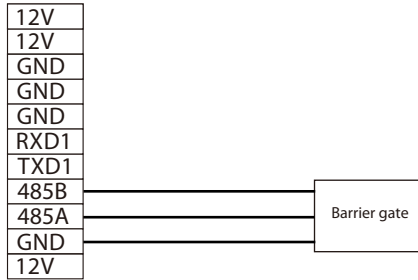
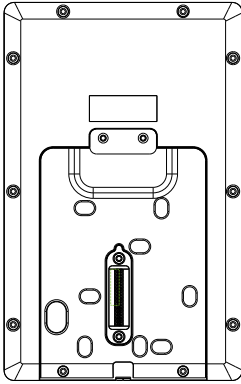

8 RS485 Connection

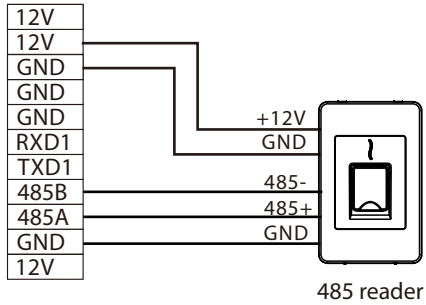
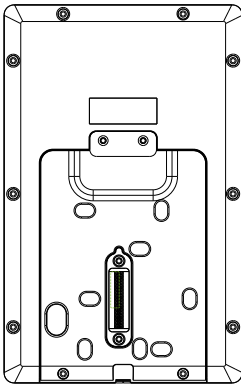

Note: 485A and 485B can be connected to the barrier gate or the 485 reader, but cannot be connected to the gate and the reader at the same time.

9 Power Connection

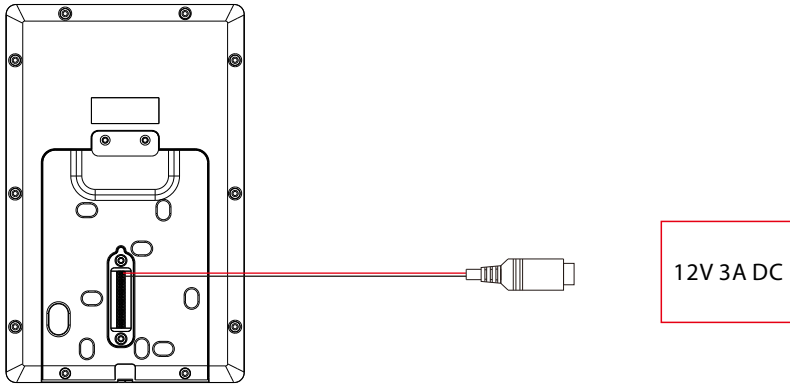

- Recommended power supply: 12V - 3A
- To share the power with other devices, use a power supply with higher current ratings.

10 Ethernet Connection

Connect the device and computer software over an Ethernet cable. An example is shown below:

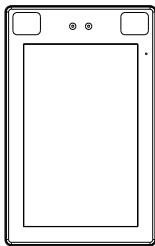

Default IP address: 192.168.1.201
Subnet mask: 255.255.255.0



IP address: 192.168.1.130
Subnet mask: 255.255.255.0

Note: In LAN, IP addresses of the server (PC) and the device must be in the same network segment when connecting to ZKBioSecurity software.

Click on [Comm.] > [Ethernet] > [IP Address], input the IP address and click on [OK].

11 User Registration

When there is no super administrator set in the device, click on ☰ to enter the menu. After setting the super administrator, the system will request for the administrator's verification before entering the menu. For the security purpose, it is recommended to register a super administrator at the first time you use the device.

Method1: Register on the device

Click on ☰ > [User Mgt.] > [New User] to register a new user. Settings include entering user ID and name, registering a face, password and user photo, setting user role and access control role.

Method2: Register on the phone

Cloud server IP address Server port
Login in to <http://X.X.X.X:XX/app/v1/adreg> with a mobile phone to register users.

Method3: Register on ZKBioSecurity software

Click on [Personnel] > [Person] > [New] to register users on the software.

For specific operation, please refer to the 'ZKBioSecurity User Manual'.

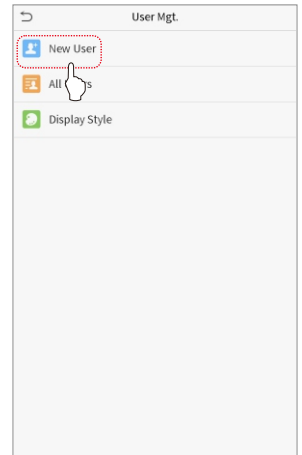
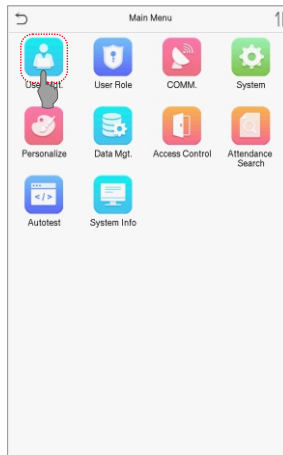
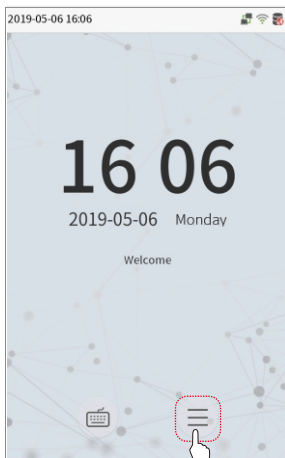

| New User | |
|---------------------|-------------|
| User ID | 2 |
| Name | |
| User Role | Normal User |
| Face | 0 |
| Password | |
| User Photo | 0 |
| Access Control Role | |

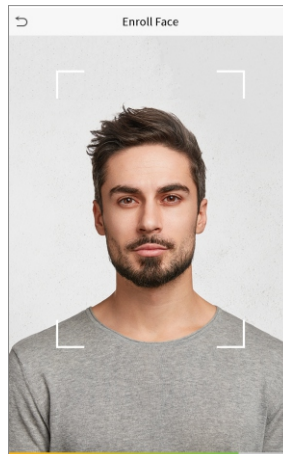

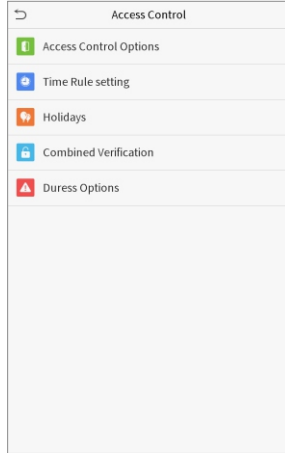
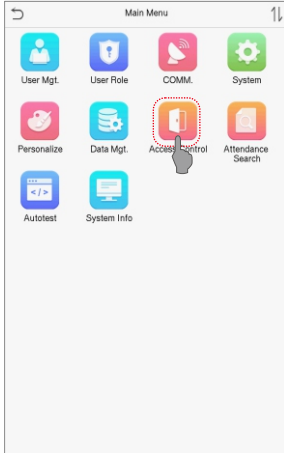

12 Access Control Settings

Click on  > [Access Control] to enter the access control management interface and set relevant parameters of access control.



13 Ethernet and Cloud Server Settings

Click on  > [Comm.] > [Ethernet] to set the network parameters. If the TCP/IP communication of the device is successful, the icon  will be displayed in the upper right corner of the standby interface.

Click on  > [Comm.] > [Cloud Server Setting] to set the server address and server port, that is, the IP address and port number of the server after the software is installed. If the device communicates with the server successfully, the icon  will be displayed in the upper right corner of the standby interface.

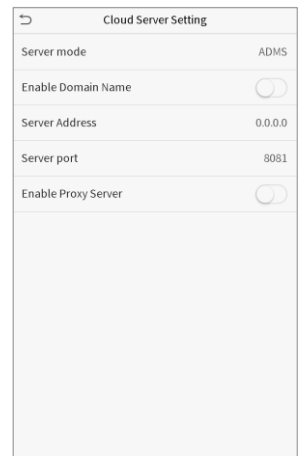
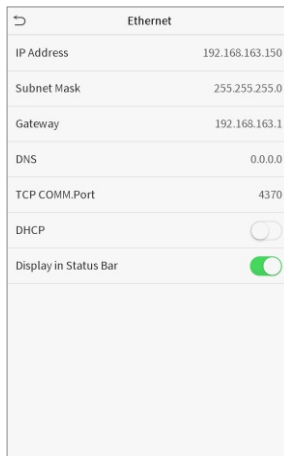
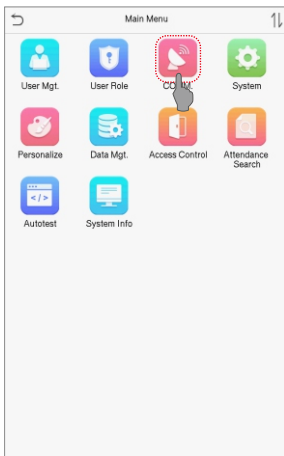

Green
Label

www.zkteco.eu

Copyright©2019 ZKTeco CO., LTD. All rights reserved.