

AC-425

Multi-Advanced Scalable Networked Access Controller

Hardware Installation and User Guide



November 2011

ROSSLARE
SECURITY PRODUCTS

Table of Contents

1 Introduction.....5

1.1 Features 7

1.2 AxTraxNG™..... 7

1.3 Compatible Readers 9

2 Technical Specifications10

3 AC-425 Panel Set-Up.....12

3.1 Inputs Wiring – Non-Supervised Inputs 13

3.2 Inputs Wiring – Supervised Inputs 14

3.3 Outputs Wiring 14

3.4 Power Supply 15

3.5 Reader 16

3.6 MD-IO84..... 17

3.7 MD-D04 17

4 Input and Output Connections.....19

4.1 Input Types..... 19

4.2 Inputs Description 24

4.3 Outputs 26

4.4 Card Readers and Keypads..... 27

5 AC-425 Hardware Settings.....30

5.1 DIP Switch Configuration 32

5.2 AC-425 Panel Baud Rate 33

5.3 AC-425 Panel Type 34

5.4 AC-425 Panel Address 34

6 Communications37

6.1 Serial Network Connection 37

6.2 TCP/IP Network Connection..... 39

6.3 Modem Network Connection 41

Appendix A. Limited Warranty43

Appendix B. Technical Support45

Notice, Copyright and Disclaimer

This manual's sole purpose is to assist installers and/or users in the safe and efficient installation and usage of the system and/or product, and/or software described herein.

Before attempting to install and/or use the system, the installer and the user must read this manual and become familiar with all safety requirements and operating procedures.

- ❖ THE SYSTEM MUST NOT BE USED FOR PURPOSES OTHER THAN THOSE FOR WHICH IT WAS DESIGNED.
- ❖ THE USE OF THE SOFTWARE ASSOCIATED WITH THE SYSTEM AND/OR PRODUCT, IF APPLICABLE, IS SUBJECT TO THE TERMS OF THE LICENSE PROVIDED AS PART OF THE PURCHASE DOCUMENTS.
- ❖ REL, RSP INC. AND/OR THEIR RELATED COMPANIES AND/OR SUBSIDIARIES' (HEREAFTER: "ROSSLARE") EXCLUSIVE WARRANTY AND LIABILITY IS LIMITED TO THE WARRANTY AND LIABILITY STATEMENT PROVIDED IN AN APPENDIX AT THE END OF THIS DOCUMENT.
- ❖ THIS MANUAL DESCRIBES THE MAXIMUM CONFIGURATION OF THE SYSTEM WITH THE MAXIMUM NUMBER OF FUNCTIONS, INCLUDING FUTURE OPTIONS. THEREFORE, NOT ALL FUNCTIONS DESCRIBED IN THIS MANUAL MAY BE AVAILABLE IN THE SPECIFIC SYSTEM AND/OR PRODUCT CONFIGURATION YOU PURCHASED.
- ❖ INCORRECT OPERATION OR INSTALLATION, OR FAILURE OF THE USER TO EFFECTIVELY MAINTAIN THE SYSTEM, RELIEVES THE MANUFACTURER (AND SELLER) FROM ALL OR ANY RESPONSIBILITY FOR CONSEQUENT NON-COMPLIANCE, DAMAGE, OR INJURY.
- ❖ THE TEXT, IMAGES AND GRAPHICS CONTAINED IN THE MANUAL ARE FOR THE PURPOSE OF ILLUSTRATION AND REFERENCE ONLY.
- ❖ IN NO EVENT SHALL MANUFACTURER BE LIABLE FOR ANY SPECIAL, DIRECT, INDIRECT, INCIDENTAL, CONSEQUENTIAL, EXEMPLARY, OR PUNITIVE DAMAGES (INCLUDING, WITHOUT LIMITATION, ANY AND ALL DAMAGES FROM BUSINESS INTERRUPTION, LOSS OF PROFITS OR REVENUE, COST OF CAPITAL OR LOSS OF USE OF ANY PROPERTY OR CAPITAL OR INJURY).
- ❖ ALL GRAPHICS IN THIS MANUAL ARE FOR REFERENCE ONLY, SOME DEVIATION BETWEEN THE IMAGE(S) AND THE ACTUAL PRODUCT MAY OCCUR.
- ❖ ALL WIRING DIAGRAMS ARE INTENDED FOR REFERENCE ONLY, THE PHOTOGRAPH OR GRAPHIC OF THE PCB(S) ARE INTENDED FOR CLEARER ILLUSTRATION AND UNDERSTANDING OF THE PRODUCT AND MAY DIFFER FROM THE ACTUAL PCB(S).

COPYRIGHT 2011 by Rosslare. All rights reserved.

This manual and the information contained herein are proprietary to ROSSLARE. Only ROSSLARE and its customers have the right to use the information.

No part of this manual may be re-produced or transmitted in any form or by any means, electronic or mechanical, for any purpose, without the express written permission of ROSSLARE.

ROSSLARE owns patents and patent applications, trademarks, copyrights, or other intellectual property rights covering the subject matter in this manual.

TEXTS, IMAGES, AND ILLUSTRATIONS INCLUDING THEIR ARRANGEMENT IN THIS DOCUMENT ARE SUBJECT TO THE PROTECTION OF COPYRIGHT LAWS AND OTHER LEGAL RIGHTS WORLDWIDE. THEIR USE, REPRODUCTION, AND TRANSMITTAL TO THIRD PARTIES WITHOUT EXPRESS WRITTEN PERMISSION MAY RESULT IN LEGAL PROCEEDINGS.

The furnishing of this manual to any party does not give that party or any third party any license to these patents, trademarks, copyrights or other intellectual property rights, except as expressly provided in any written agreement of ROSSLARE.

ROSSLARE reserves the right to revise and change this document at any time, without being obliged to announce such revisions or changes beforehand or after the fact.

1. Introduction

The AC-425 access control panel is a state-of-the-art networked access controller, employing the latest technology to meet the requirements of the market.

The state-of-the-art dual/quad door AC-425 networked access controller is the backbone of medium scale security systems handling up to 30,000 users and 8184 doors.

Each AC-425 Access Control Unit (ACU) supports four readers (In/Out) of various formats including standard Wiegand 26-bit. Installations can also have one reader per door.

Driven by Rosslare's powerful, flexible and easy to use AxTraxNG™ software, the system provides an ideal, modular and expandable solution for commercial and institutional needs. It provides seamless integration with Rosslare's range of RFID proximity, PIN, PIN & PROX, smartcard and biometric readers with Rosslare's selection of RFID credentials.

The AC-425 is ready for installation with a mountable & lockable metal enclosure integrated with transformer, power supply/charger, sounder and control board.

Using onboard RS-232/485, Ethernet TCP/IP, multiple local or remote site door sub-networks can connect to the AxTraxNG Client/Server PC software running on Microsoft® Windows® 98/ME & NT/2000/XP/7 operating systems.

The AC-425 consists of the following components:

- AC-425 controller board
- Panel enclosure
- PS-33 power supply
- Power Transformer
- 4 x 2.2 kOhm and 4 x 8.2 kOhm resistors for the supervised inputs.

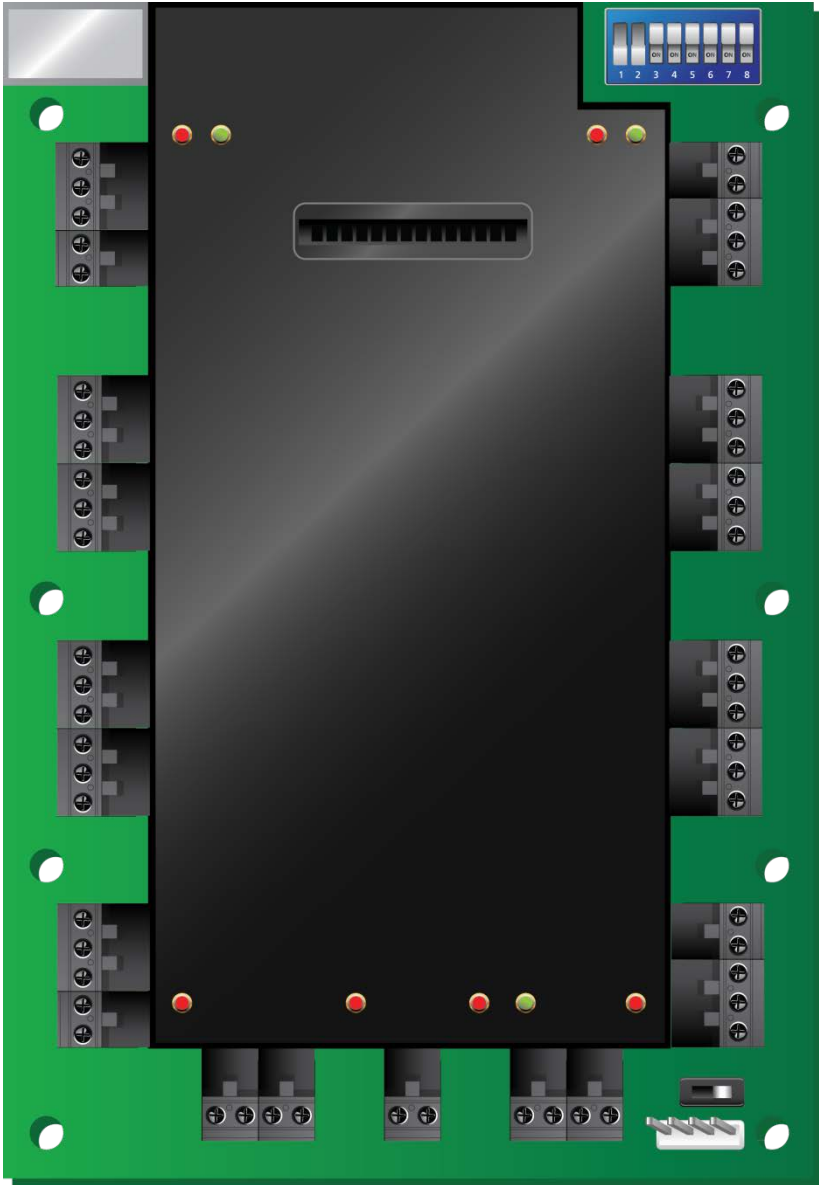

Figure 1: AC-425 panel

1.1 Features

The AC-425 is a powerful and adaptable access control solution with a range of powerful features.

- Controls 1 to 4 doors (DIP switch controlled) or 1 to 8 doors when the optional MD-D04 is installed
- Four IN/OUT readers, with tamper switch and LED control
- Four inputs, selectable as supervised or non-supervised
- Four Form-C relay outputs (rated 5 A)
- Optional MD-IO84 with an additional 4 relay outputs and 8 inputs, selectable as supervised or non-supervised
- Optional MD-D04 with 4 readers, 4 relay outputs, and 4 inputs selectable as supervised or non-supervised
- Built-in sounder generator for chime, bell and siren signals
- Panel configuration DIP switch
- Up to 32 access control panels in every network (128 doors in every network or a 256-door network when optional MD-D04 installed)
- 30,000 users
- 20,000 FIFO, history event log
- RS-232 or RS-485 serial communication (up to 115200 bps)
- On-board TCP/IP communication
- Remote firmware upgrades
- Removable terminal blocks
- Real-time clock keeps time for up to 2 weeks without power (no batteries to replace)

1.2 AxTraxNG™

The AxTraxNG™ software system is custom designed to set up, manage, and supervise all aspects of an access panel network.

Introduction

It offers the following capabilities:

Parameter	Value
Users capacity	30,000
Unauthorized Users	30,000
Access groups	30,000
Number of panels in system	1023
Number of doors in system	8184



Note:

These options are software and firmware dependent, and may change in later releases or revisions.

1.2.1 Client-Server Structure

AxTraxNG™ operates through a dedicated AxTraxNG™ server computer, which communicates with the access control panels and can serve an unlimited number of network clients.

The server also runs the system's SQL database, which contains settings and definitions for access control across the entire facility. System users can define new cards holders and users, and control access permissions. The system includes tools for database backup, input, and export of previous configurations and automatic backup on a periodic basis.

AxTraxNG™ supports all panel types and offers scalability and flexibility in addition to a range of advanced control features.

1.2.2 Configurable Links

The system's configurable links model makes it possible to trigger any chosen output automatically or report a configurable alarm, based on a selected input. This allows easy integration with other access systems such as intruder alarms, CCTV systems, and elevator controls.

AxTraxNG™ can also define a selected set of operations, which are defined in configurable links, when a panel registers a specified user or group of users. This can be useful, for

example, in elevator control systems. The system can assign users with counters, allowing a limited number of entries to each panel.

1.2.3 Fingerprint Recognition

AxTraxNG™ can share user details with Rosslare's BioTrax software system. The BioTrax system can then download all selected user information to an AYC-W6500 fingerprint reader.

**Note:**

Fingerprint recognition was not evaluated by UL.

1.3 Compatible Readers

For UL-compliant installations, use any of the following UL-listed PIN and PROX card readers made by Rosslare:

AY-H12, AY-J12, AY-K12, AY-L12, AY-M12, AY-Q12, AYC-F54, AYC-F64, AYC-G54, AYC-G64, AYC-Q54B, or AYC-Q64B

2. Technical Specifications

Parameter	Description/Value
Electrical Characteristics	
Operating Voltage	13.8 VDC 1.5 A from PS-33
Maximum Input Current	Standby: 80 mA Maximum: 325 mA
General Inputs	4 supervised high impedance inputs. 8 or 12 supervised inputs when using MD-D04 or MD-IO84 expansion boards Maximum voltage: 5 VDC
Relay Outputs	4 relay outputs 8 supervised outputs when using MD-D04 or MD-IO84 expansion boards 5A relay N.O. and N.C. options
Reader Ports	Standard = 4 reader ports With MD-D04 = 8 reader ports Output voltage: 12 VDC Max. current: 245 mA LED control output D0/D1, tamper input
Visual Indicators	9 LEDs (14 LEDs with MDD04)
Audio	Built-in sounder (bell, chime, and siren)
Battery Standby Time	3 hours (with 12 V battery)
Communication Characteristics	
RS-232	Terminal Block
RS-485	Molex and Terminal Block
TCP/IP	On-board RJ-45 connector Internal IP module
Speed Options	9600, 19200, 57600, 115200 bps
Environmental Characteristics	
Operating Temperature Range	32°F – 120°F (0°C – 49°C)
Operating Humidity	0 – 85% (non-condensing)

Technical Specifications

Parameter	Description/Value
Dimensions	
Height x Width x Depth	10.4 x 13.2 x 3.4 in. 264 x 334 x 84.5 mm
Weight	8.38 lbs. (3.80 kg)
PS-33 Power Supply Specifications	
Input Voltage	16.5 VAC, 3 A
Backup Battery Charger Output	12 VDC, 300 mA
To Access control panel – Output Voltage 1	13.8 VDC, 1.5 A
To Relay Outputs Output Voltage 2	13.8 VDC, 0.9 A
PS-33 Power Supply Indication	
Tamper Output (open collector)	Indicates faulty power
PS-33 Power LEDs	
Power In (AC) Green LED1	Main power
Power Out (DC) Red LED2	Low voltage
Low Battery Red LED3	Backup battery low voltage

3. AC-425 Panel Set-Up

Each AC-425 panel controls 2 or 4 doors (up to 8 doors with MD-D04). The panels connect together in a network and are controlled by a central server computer, running the AxTraxNG™ software system.

The following diagram shows an example setup for a network of AC-425 access control panels.

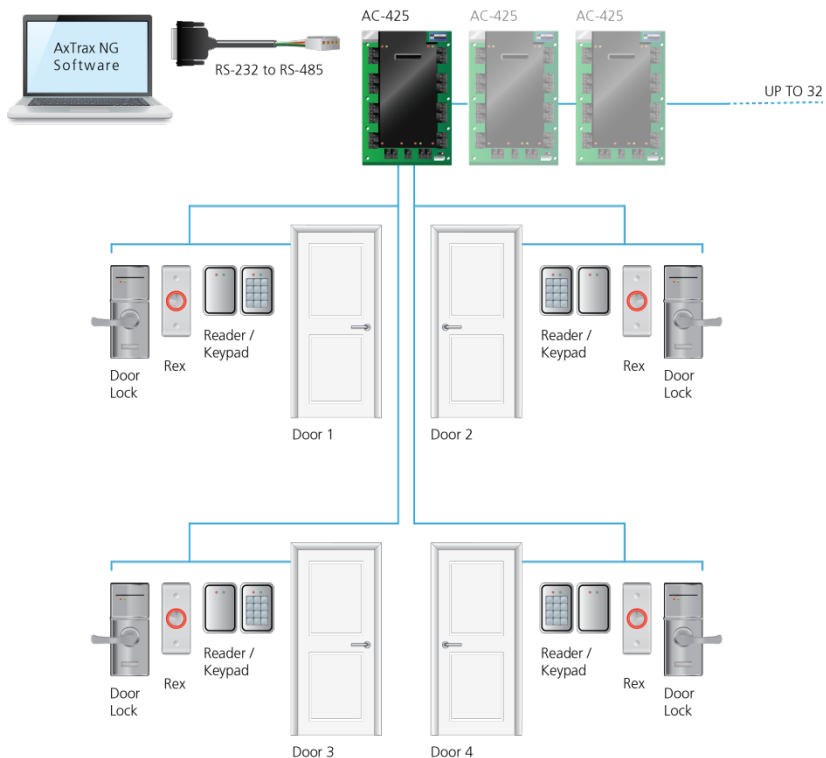

Figure 2: Sample AC-425 Configuration



Note:

Bushings are needed for any conductors leaving the enclosure through the provided openings.

3.1 Inputs Wiring – Non-Supervised Inputs

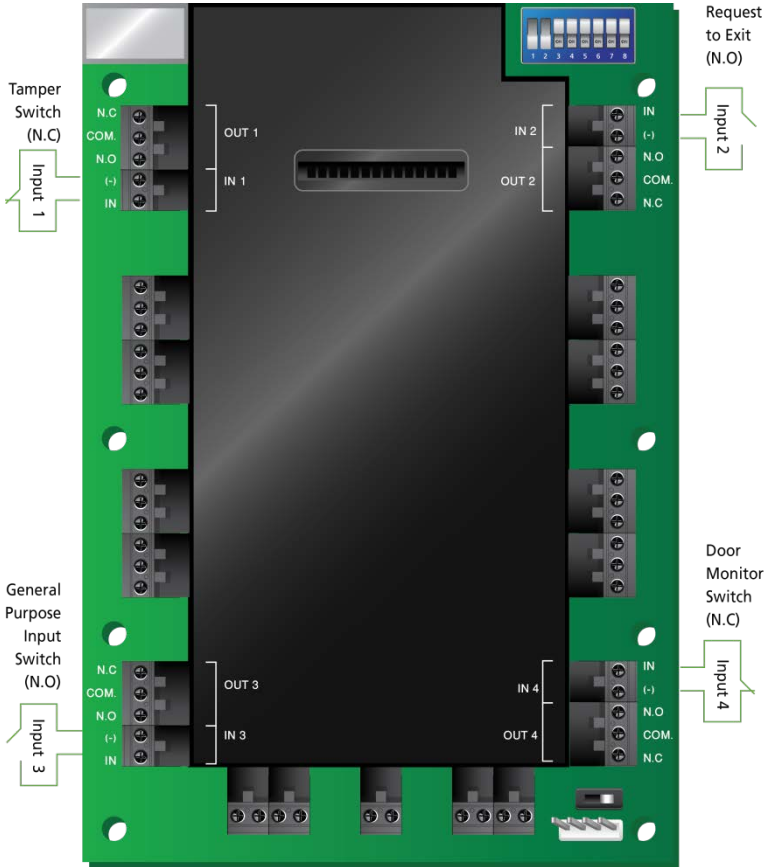

Figure 3: Inputs Wiring – Non-supervised Inputs

3.2 Inputs Wiring – Supervised Inputs

When wiring the AC-425 for supervised inputs, resistors should be placed on the input switch and not on the terminal block.

For more details, refer to Input and Output Connections on page 19.

3.3 Outputs Wiring

The following diagram illustrates wiring for two main types of 12 VDC electrical release mechanisms. Other electrical devices can be switched using the voltage free relay contacts.

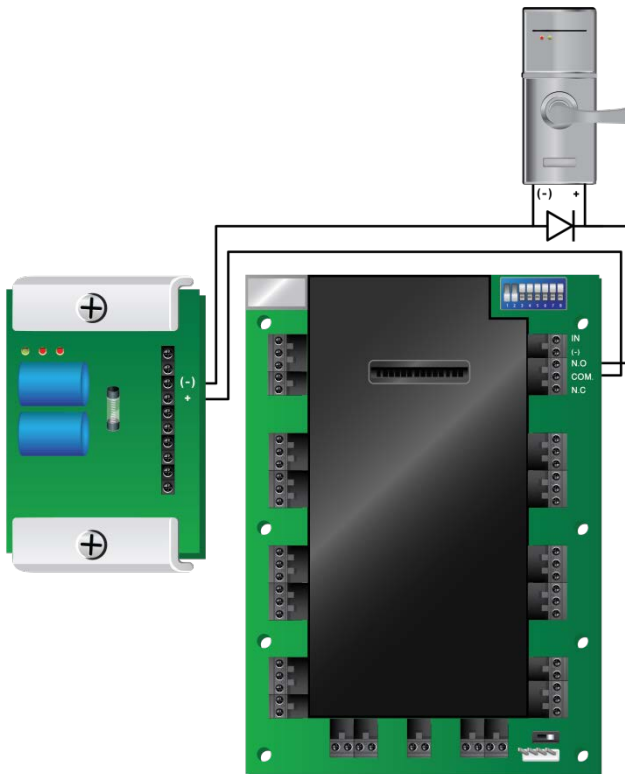

Figure 4: Door Lock – Failed Close

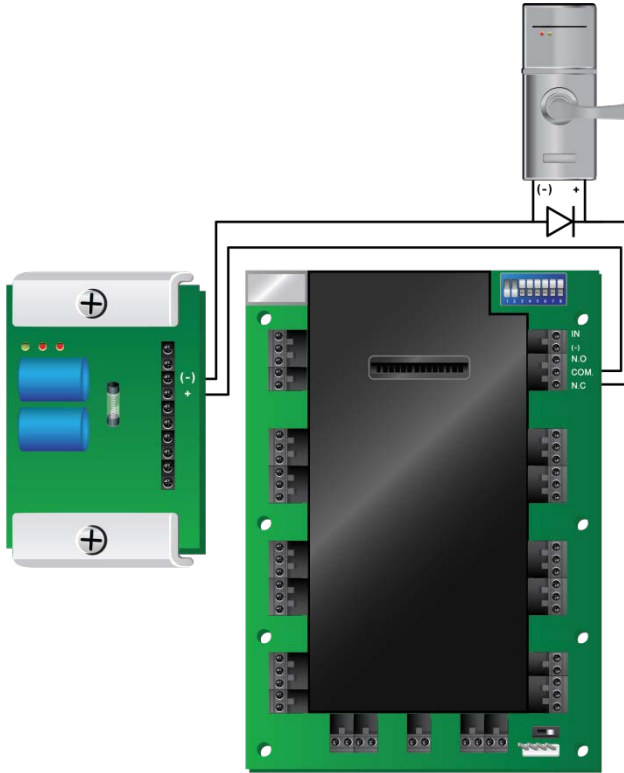

Figure 5: Door Lock – Failed Open

3.4 Power Supply

The following diagram illustrates wiring between the PS-33 power supply and the AC-425. It is recommended to add a 12 VDC lead acid backup battery if the main power supply fails. If the main output is 12 VDC, wire it to the PS-33, whose load ratings are 1.5 A/0.9 A/0.3 A; otherwise, you should support your power supply according to the output requirements. For more information, refer to the Outputs on page 26. A 12 V 7 AH battery will provide 3 hours of backup operation.

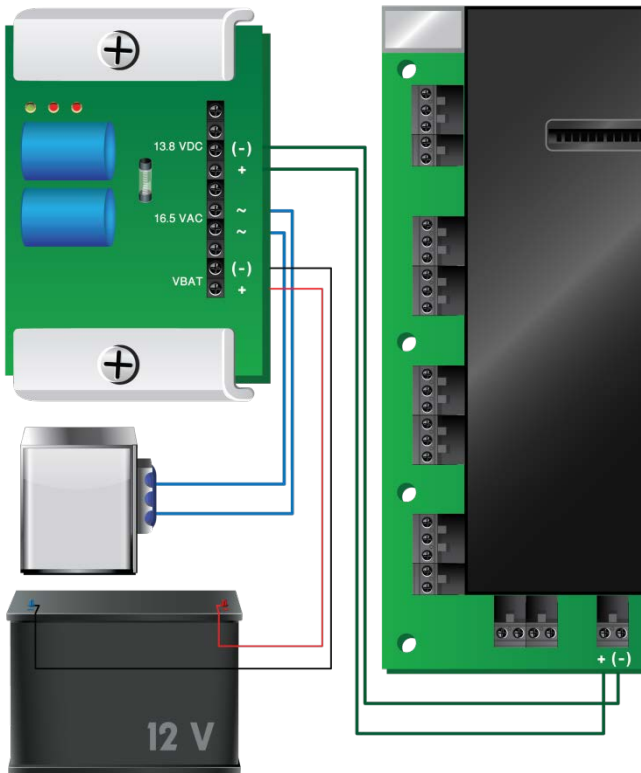

Figure 6: Wiring Between PS-33 and AC-425

3.5 Readers

Proximity & keypad readers are supplied with a limited cable. The color of the cable cover represents the cable's function according to Wiegand standards.



Note:

When extending the cable distance, be careful with the color of the cable cover.

Refer to the reader specifications for the maximum cable length (typically 150 m with an 18 AWG cable).

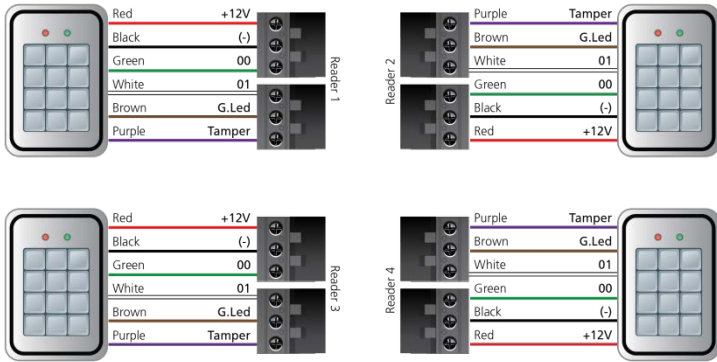

Figure 7: Reader Wiring

3.6 MD-IO84

The MD-IO84 is an optional I/O expansion board that adds 4 relay outputs and 8 supervised inputs to the Access Control Panel. Attach the MD-IO84 to the AC-425's expansion slot, as marked in red in Figure 8). For more information, see the MD-IO84 Installation and User Guide.

3.7 MD-D04

The MD-D04 is an optional reader expansion board that adds 4 readers, 4 relay outputs and 4 supervised inputs to the Access Control Panel. Attach the MD-D04 to the AC-425's expansion slot, as marked in red in Figure 8. For more information, see the MD-D04 Installation and User Guide.

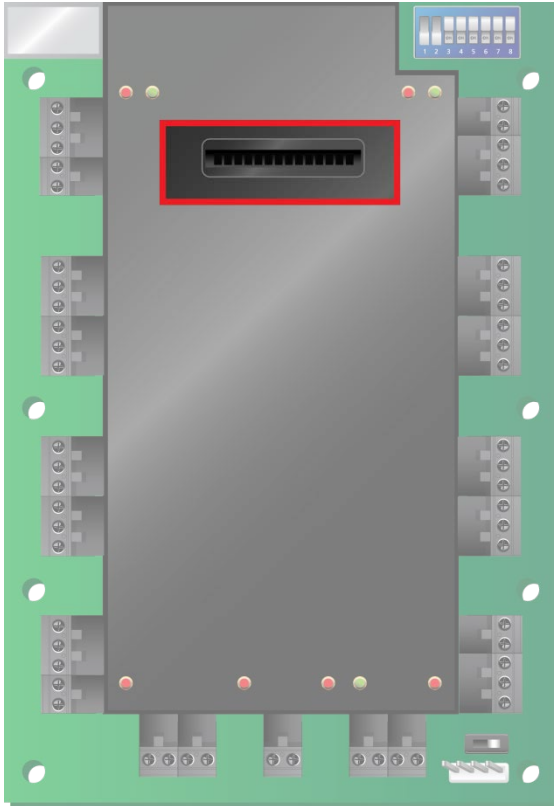

Figure 8: Connector Location for MD-IO84 or MD-D04 Expansions

4. Input and Output Connections

This chapter describes the AC-425 access control panel's input and output connections.

4.1 Input Types

There are four input types:

- N.C.
- N.O.
- Single EOL resistor
- Double EOL resistor

Inputs IN1, IN2, IN3, and IN4 may be configured individually as either supervised or non-supervised inputs. Use the AxTraxNG™ system to configure each input separately.

Non-supervised inputs have two states:

- Normal
- Abnormal

Supervised inputs have three states:

- Normal
- Abnormal
- Trouble

The Trouble state is caused by either tampering with the input circuit or by faulty hardware installation. Once an input is configured as a supervised input, add a resistor of 2.2 k Ω , of 8.2 k Ω , or both on the input circuit. See the following diagrams.

4.1.1 Normally Open Input Connection

A Normally Open Input has 2 states:

- Switch Open – Normal State:
Loop resistance = Infinite (open circuit)
- Switch Closed – Abnormal State:
Loop resistance = 0 (short circuit)

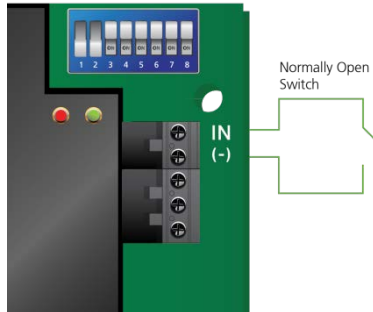

Figure 9: Normally Open Input Connection

4.1.2 Normally Closed Input Connection

A Normally Closed Input has two states:

- Switch Closed – Normal State:
Loop resistance = 0 (short circuit)
- Switch Open – Abnormal State:
Loop resistance = Infinite (open circuit)

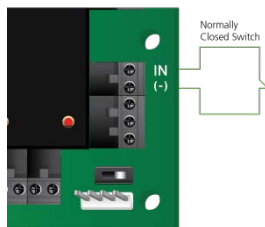

Figure 10: Normally Closed Input Connection

4.1.3 Normally Open Supervised Single EOL Resistor Input Connection

Connect an 8.2 k Ω resistor in parallel to the input switch contacts.

A Normally Open Supervised Input has 3 states:

- Switch Open – Normal State:
Loop resistance = 8.2 k Ω
- Switch Closed – Abnormal State:
Loop resistance = 0 (short circuit)
- Open circuit across input terminals – Trouble State:
Loop resistance = Infinite (open circuit).

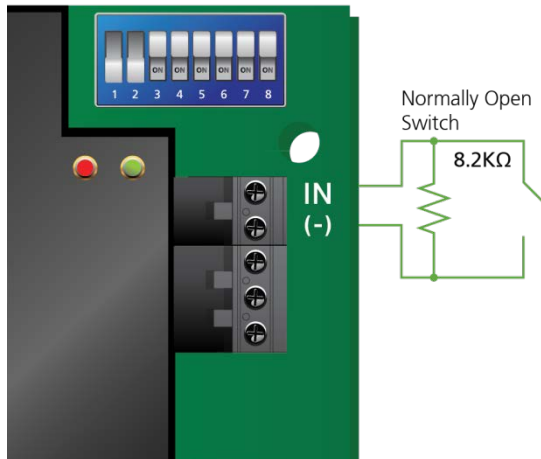

Figure 11: Normally Open Supervised Input (Single Resistor)

4.1.4 Normally Open Supervised Double EOL Resistor Input Connection

Connect a 2.2 k Ω resistor in series to the input switch contacts.

Connect an 8.2 k Ω resistor parallel to the input switch contacts.

Input and Output Connections

A Normally Open Supervised Input has 3 states:

- Switch Open – Normal State:
Loop resistance = $10.4\text{ k}\Omega$
- Switch Closed – Abnormal State:
Loop resistance = $2.2\text{ k}\Omega$
- Open circuit (infinite loop resistance) or short circuit (0 resistance) across input terminals – Trouble State

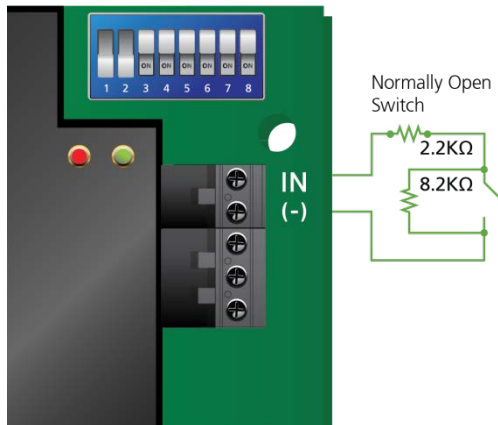

Figure 12: Normally Open Supervised Input (Double Resistor)

4.1.5 Normally Closed Supervised Single EOL Resistor Input Connection

Connect a $2.2\text{ k}\Omega$ resistor in series to the input switch contacts.

A Normally Closed Supervised Input has 3 states:

- Switch Closed – Normal State:
Loop resistance = $2.2\text{ k}\Omega$
- Switch Open – Abnormal State:
Loop resistance = Infinite (open circuit)
- Short circuit across input terminals – Trouble State:
Loop resistance = 0 (short circuit)

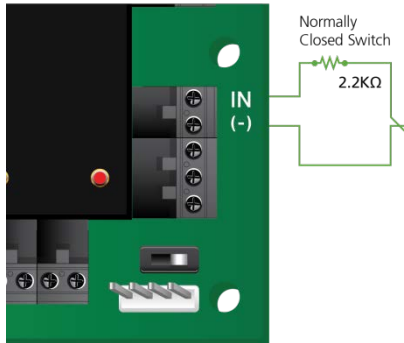

Figure 13: Normally Closed Supervised Input (Single Resistor)

4.1.6 Normally Closed Supervised Double EOL Resistor Input Connection

Connect a 2.2 kΩ resistor in series to the input switch contacts.

Connect an 8.2 kΩ resistor parallel to the input switch contacts.

A Normally Closed Supervised Input has 3 states:

- Switch Closed – Normal State:
Loop resistance = 2.2 kΩ
- Switch Open – Abnormal State:
Loop resistance = 10.4 kΩ
- Open circuit (infinite loop resistance) or short circuit (0 resistance) across input terminals – Trouble State

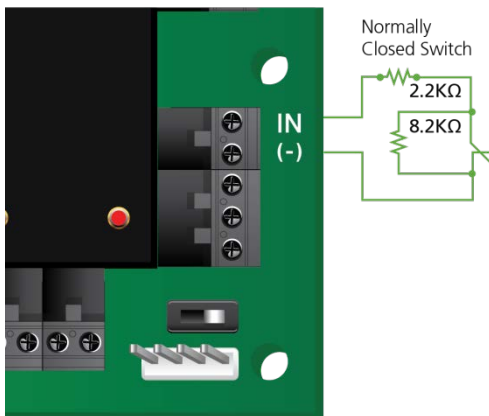

Figure 14: Normally Closed Supervised Input (Double Resistor)

4.2 Inputs Description

4.2.1 Request to Exit Button (REX) Input

Use the REX Input to open a door directly. Typically, the REX input is connected to a Normally Open push button that is located inside the premises. The push button is generally located in an easy-to-access position and opens a door without reading a proximity card or PIN code.

Scenario	Setting
Two readers per door	Door 1 – IN 1
	Door 2 – IN 2
One reader per door	Door 1 – IN 1
	Door 2 – IN 2
	Door 3 – IN 3
	Door 4 – IN 4

REX Inputs functions when using MD-D04:

Scenario	Setting
Two readers per door	Door 1 – IN1
	Door 2 – IN2
	Door 5 – IN5
	Door 6 – IN6
One reader per door	Door 1 – IN1
	Door 2 – IN2
	Door 3 – IN3
	Door 4 – IN4
	Door 5 – IN5
	Door 6 – IN6
	Door 7 – IN7
	Door 8 – IN8

4.2.2 Door Monitor Input

The Door Monitor Input typically connects to a Normally Closed door sensing micro-switch for door status monitoring. Using Door Monitor enables many advanced options such as door forced alarm, door held open warnings, interlocking doors and more. Door monitor feature is only available when the system is defined as a two reader per door. The following should be defined:

Scenario	Setting
Two readers per door	Door 1 – IN3
	Door 1 – IN4

Dedicated Inputs functions when using MD-D04:

Scenario	Setting
Two readers per door	Door 1 – IN3
	Door 2 – IN4
	Door 3 – IN7
	Door 4 – IN8

Input and Output Connections

4.2.3 General Purpose Inputs

These are free inputs that can be used for various functions. This function is only available with the MD-IO84 expansion. The following should be defined:

Scenario	Setting
Single door controller	Door 1 – IN 2 Door 1 – IN 2A
Double door controller	(no general purpose inputs available)

General purpose inputs are suitable for most uses. For example, they might be used to detect tampering, to activate alarm sensors, or to monitor a power supply failure.

General purpose inputs functions when using MD-IO84 or MD-D04:

Unit	Expansions
MD-IO84	IN5 to IN12
MD-D04	IN5 to IN8 except the dedicated inputs

4.3 Outputs

Rosslare Security recommends the use of suppression diodes for all outputs that activate an inductive load.

4.3.1 Door Lock

There are two types of door locking devices:

- Fail open (fail secure)
- Fail close (fail safe)

The following should be defined:

Scenario	Setting
Two readers per door	Door 1 – OUT 1
	Door 2 – OUT 2
One reader per door	Door 1 – OUT 1
	Door 2 – OUT 2
	Door 3 – OUT 3

Scenario	Setting
	Door 4 – OUT 4

Door outputs when using MD-D04:

Scenario	Setting
Two readers per door	Door 1 – OUT 1
	Door 2 – OUT 2
	Door 3 – OUT 5
	Door 4 – OUT 6
One reader per door	Door 1 – OUT 1
	Door 2 – OUT 2
	Door 3 – OUT 3
	Door 4 – OUT 4
	Door 5 – OUT 5
	Door 6 – OUT 6
	Door 7 – OUT 7
	Door 8 – OUT 8

The output can sink current from any power supply (see page 15).



Note:

For UL installations, the installer must configure the system as fail-safe to comply with NFPA (National Fire Protection Association) regulations.

4.4 Card Readers and Keypads

Each access control panel can be connected to a maximum of four readers or 8 readers when using MD-D04. There are three available types of reader:

- Card readers
- Keypads
- Dual keypad card readers

A keypad is required for any reader mode that requires PIN code entries, such as "Card or PIN", "PIN Only" or "Card and PIN (Secured mode)".

When connecting a reader, the following should be defined:

Input and Output Connections

Scenario	Setting
Two readers per door	Door 1 – Reader 1 IN/OUT
	Door 1 – Reader 3 IN/OUT
	Door 2 – Reader 2 IN/OUT
	Door 2 – Reader 4 IN/OUT
One readers per door	Door 1 – Reader 1 IN/OUT
	Door 2 – Reader 2 IN/OUT
	Door 3 – Reader 3 IN/OUT
	Door 4 – Reader 4 IN/OUT

When using the MD-D04, the following should be defined:

Scenario	Setting
Two readers per door:	Door 1 – Reader 1 IN/OUT
	Door 1 – Reader 3 IN/OUT
	Door 2 – Reader 2 IN/OUT
	Door 2 – Reader 4 IN/OUT
	Door 3 – Reader 5 IN/OUT
	Door 3 – Reader 7 IN/OUT
	Door 4 – Reader 6 IN/OUT
	Door 4 – Reader 8 IN/OUT
One readers per door:	Door 1 – Reader 1 IN/OUT
	Door 2 – Reader 2 IN/OUT
	Door 3 – Reader 3 IN/OUT
	Door 4 – Reader 4 IN/OUT
	Door 5 – Reader 5 IN/OUT
	Door 6 – Reader 6 IN/OUT
	Door 7 – Reader 7 IN/OUT
	Door 8 – Reader 8 IN/OUT

Use the AxTraxNG™ software to set the readers for IN or OUT use and to set the data transmission format for each reader.

The reader's tamper output connects to the access control panel's Reader-Tamper input. If the reader is interfered with, an alarm can be generated.

The panel's Reader G.LED output activates the reader's green LED input when operating in "Card and PIN" secure mode.

While this mode is in force, users must enter a PIN on the keypad immediately after entering the card.

The controller activates the LED control for 2 seconds when an access granted event occurs.

5. AC-425 Hardware Settings

Each AC-425 panel controls an entrance. The behavior of the panel is controlled by DIP switch settings.

Select the appropriate DIP switch setting to operate the panel as either a single door, a double door, or four doors. Refer to AC-425 Panel Type, on page 34.

Access control panels, configured as either single door or double door controllers, have two readers, IN or OUT. Access control panels configured with the MD-D04 expansion as either double door or four-door controllers have four readers.

Connectors	Description	Setup
Two readers per door:		
Outputs	Door 1 Lock output	(OUT 1)
	Door 2 Lock output	(OUT 2)
	General purpose output	(OUT 3)
	General purpose output	(OUT 4)
Inputs	Door 1: Request to exit	(IN 1)
	Door monitor input	(IN 3)
	Door 2: Request to exit	(IN 2)
	Door monitor input	(IN 4)
Readers	Reader1 – Door1	Door Entry or Exit
	Reader2 – Door2	Door Exit or Entry
	Reader3 – Door1	Door Entry or Exit
	Reader4 – Door2	Door Exit or Entry
One reader per door:		
Outputs	Door1 Lock output	(OUT 1)
	Door2 Lock output	(OUT 2)
	Door3 Lock output	(OUT 3)
	Door4 Lock output	(OUT 4)
Inputs	Door1 Request to exit	(IN 1)
	Door2 Request to exit	(IN 2)
	Door3 Request to exit	(IN 3)
	Door4 Request to exit	(IN 4)

Connectors	Description	Setup
Readers	Reader1	(Door1 IN/OUT)
	Reader2	(Door2 IN/OUT)
	Reader3	(Door3 IN/OUT)
	Reader4	(Door4 IN/OUT)

Two readers per door with 8 readers (MD-D04):

Outputs	Door1 Lock output	(OUT 1)
	Door2 Lock output	(OUT 2)
	Door3 Lock output	(OUT 5)
	Door4 Lock output	(OUT 6)
Inputs	Door1 Request to exit	(IN 1)
	Door1 monitor input	(IN 3)
	Door2 Request to exit	(IN 2)
	Door2 monitor input	(IN 4)
	Door3 Request to exit	(IN 5)
	Door3 monitor input	(IN 7)
	Door4 Request to exit	(IN 6)
	Door4 monitor input	(IN 8)
Readers	Reader1	(Door1 IN/OUT)
	Reader2	(Door2 OUT/IN)
	Reader3	(Door1 IN/OUT)
	Reader4	(Door2 OUT/IN)
	Reader5	(Door3 IN/OUT)
	Reader6	(Door4 OUT/IN)
	Reader7	(Door3 IN/OUT)
	Reader8	(Door4 OUT/IN)

One reader per door with 8 readers (MD-D04)

Outputs	Door1 Lock output	(OUT 1)
	Door2 Lock output	(OUT 2)
	Door3 Lock output	(OUT 3)
	Door4 Lock output	(OUT 4)
	Door5 Lock output	(OUT 5)
	Door6 Lock output	(OUT 6)
	Door7 Lock output	(OUT 7)
	Door8 Lock output	(OUT 8)

AC-425 Hardware Settings

Connectors	Description	Setup
Inputs	Door1 Request to exit	(IN 1)
	Door2 Request to exit	(IN 2)
	Door3 Request to exit	(IN 3)
	Door4 Request to exit	(IN 4)
	Door5 Request to exit	(IN 5)
	Door6 Request to exit	(IN 6)
	Door7 Request to exit	(IN 7)
	Door8 Request to exit	(IN 8)
Readers	Reader1	(Door1 IN/OUT)
	Reader2	(Door2 OUT /IN)
	Reader3	(Door3 IN/OUT)
	Reader4	(Door4 OUT /IN)
	Reader5	(Door5 IN/OUT)
	Reader6	(Door6 OUT /IN)
	Reader7	(Door7 IN/OUT)
	Reader8	(Door8 OUT /IN)

5.1 DIP Switch Configuration

The AC-425 panel DIP switch controls a number of operating parameters, including the device address and baud rates for serial communication.

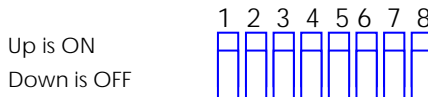

Figure 15: DIP Switch

The following is a list of DIP switch numbers and their functions:

DIP Switch	Function
1	Panel's communication baud rate.
2	
3	Panel type Defines the number of readers for each door – one or two readers per door. This will also affect the number of doors controlled by the panel.

4	AC-425 panel's RS-485 network address.
5	
6	
7	
8	



Note:

Power off the access control panel before changing the DIP switch settings.

After changes have been made, reboot the panel. The new settings are automatically defined after power up.

5.2 AC-425 Panel Baud Rate

The AC-425 panel serial port baud rate, set in DIP switches 1 and 2, defines the communication speed for connecting with a PC in a network connection.

The default baud rate is set to 9600 bits per second.

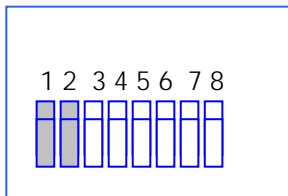

Figure 16: DIP Switch with Baud Rate Setting

The following lists the status of Switches 1 and 2 and the baud rate:

Switch 1	Switch 2	Baud Rate
Off	Off	9600
Off	On	19200
On	Off	115200
On	On	57600



Note:

The access control panel baud rate must be identical to the AxTraxNG™ Network configuration of baud rate.

5.3 AC-425 Panel Type

The AC-425 panel type is defined using the third DIP switch. There are two panel types: a panel with one reader per each door or a panel with two readers per each door. This DIP switch setting influences the number of readers per door in the panel.

The default AC-425 panel setting is for two readers per each door.

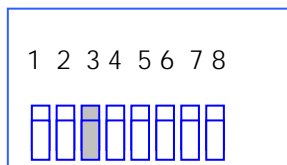

Figure 17: DIP Switch for Door Setting

- **Off** – Defines using two readers for each door. Panel controls two or four doors when MD-D04 is installed.
- **On** – Using one reader for each door. Panel controls four doors or eight doors when MD-D04 installed.

5.4 AC-425 Panel Address

The last 5 DIP switches are used to set the binary code of the access control panel internal network address.

The default access control panel address is "1".

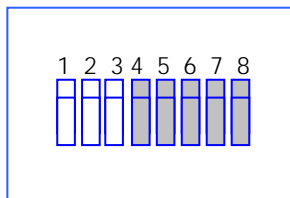

Figure 18: DIP Switch with Internal Network Address Setting

**Note:**

For successful communications, the DIP switch must match the address set in the AxTraxNG™ software.

The following table displays the 32 address settings available:

Address	Switch 4	Switch 5	Switch 6	Switch 7	Switch 8
1	Off	Off	Off	Off	Off
2	Off	Off	Off	Off	On
3	Off	Off	Off	On	Off
4	Off	Off	Off	On	On
5	Off	Off	On	Off	Off
6	Off	Off	On	Off	On
7	Off	Off	On	On	Off
8	Off	Off	On	On	On
9	Off	On	Off	Off	Off
10	Off	On	Off	Off	On
11	Off	On	Off	On	Off
12	Off	On	Off	On	On
13	Off	On	On	Off	Off
14	Off	On	On	Off	On
15	Off	On	On	On	Off
16	Off	On	On	On	On
17	On	Off	Off	Off	Off
18	On	Off	Off	Off	On
19	On	Off	Off	On	Off
20	On	Off	Off	On	On
21	On	Off	On	Off	Off
22	On	Off	On	Off	On

AC-425 Hardware Settings

Address	Switch 4	Switch 5	Switch 6	Switch 7	Switch 8
23	On	Off	On	On	Off
24	On	Off	On	On	On
25	On	On	Off	Off	Off
26	On	On	Off	Off	On
27	On	On	Off	On	Off
28	On	On	Off	On	On
29	On	On	On	Off	Off
30	On	On	On	Off	On
31	On	On	On	On	Off
32	On	On	On	On	On



Note:

The AC-425 panel address is defined in the AxTraxNG™ software.

The DIP switch and the software must be set to the same address.

6. Communications

Communication lines are used to upload and download information between the AC-425 panel and the AxTraxNG™ server. When the access control panel and the computer are communicating, the system's two LEDs flash accordingly.

- The RX LED flashes when the controller receives data
- The TX LED flashes when the controller transmits data

There are three connection modes:

- Serial Network (RS-232 or RS-485)
- Modem Network
- TCP/IP Network

6.1 Serial Network Connection

The computer serial port controlling the access control panel is set from within the AxTraxNG™ server. The default baud rate is 9600 bps for direct connection to the computer.

When using an RS-232 connector, only one AC-425 panel can be linked to each communication port on the computer. Use an RS-485 if you wish to connect more than one panel on one communication port.



Note:

The J1 switch must be set to the correct position to select the RS-232 communication.

6.1.1 RS-232 Connection to the Computer

Set the J1 switch to the RS-232 position.

Access control panel	DB9 Connector	DB25 Connector
GND	Pin 5	Pin 7
Tx	Pin 2	Pin 3
Rx	Pin 3	Pin 2

**Note:**

The RS-232 connects the computer to only a single AC-425 panel.

The distance between the computer and the AC-425 panel must be no more than 150 feet (50 meters).

If the baud rate is increased to 57600 or beyond, the distance must be no more than 30 feet (10 meters).

6.1.2 RS-485 Connection to the Computer

Set the J1 switch to the RS-485 position.

Up to 32 access control panels (AC-425, AC-225, AC-215, or AC-525) can be linked together and connected to a single communication port on the computer.

Use the RS-485 interface for situations where there are multiple controllers connected. The serial port used to control the access control panel is assigned within the AxTraxNG™ software.

The AC-425 panel supports a 2-wire RS-485 interface. Using the RS-485 interface can increase the distance between server and panels up to 4,000 feet.

To use the RS-485 interface, the panels must be connected in a daisy-chain formation with an MD-14 adapter.

6.1.3 Daisy Chaining

You can connect up to 32 panels to a single serial line using a daisy-chain formation.

The first panel is connected directly to the server using an MD-14 adaptor, while the second panel connects to the first panel. Additional panels are connected in the same way, one after another. The maximum distance from the PC to the last panel in the chain is 4,000 ft (1,219.2 m).

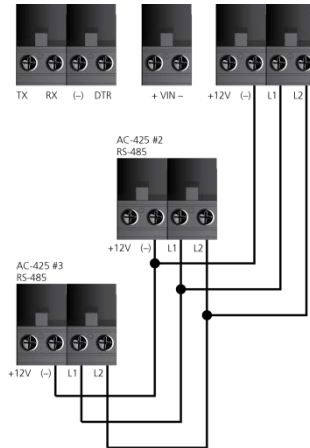
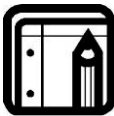

Figure 19: Daisy Chaining

At each end of the data line, both where the panel connects to the server and on the last panel in the network, a termination resistor of 120 Ω may be required. Apply the resistor across the L1 and L2 connections.



Note:

These termination resistors are especially important in long cable runs.

6.2 TCP/IP Network Connection

The computer running the AxTraxNG™ server can communicate with the access control panels via a TCP/IP network. The connection settings are controlled within the AxTraxNG™ Client software.

AC-425 panels connect to the TCP/IP network (LAN or WAN) directly, using an on-board network module. When an access control panel network is connected using RS-485, up to 32 panels can be connected on each TCP/IP network.

6.2.1 LAN and WAN Requirements

The devices can be connected to a TCP/IP network using any valid network address.

Use a TCP/IP connection when a LAN network already exists and the long RS-485 network is not required. The following schematic illustrates the connection of a single AC-425 to a computer via a LAN network.

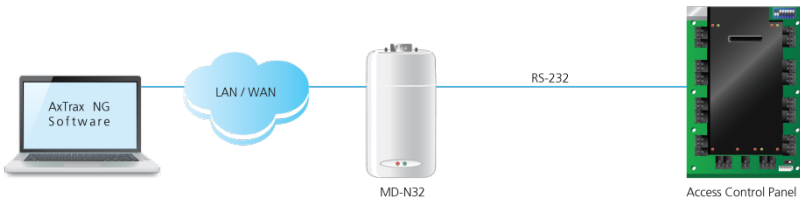

Figure 20: MD-N32 Configuration connecting a single panel

The maximum distance from the Ethernet port of the panel to the LAN/WAN connection is 328 ft. (99.97 m).

When the TCP/IP connection is implemented over a Wide Area Network (WAN), it becomes possible to connect through the Internet. This makes it possible to control multiple access control panels worldwide, all from a single server.



Figure 21: Connecting Multiple Access control panels with AC-425

Before connecting a panel by TCP/IP connection for the first time, the AxTraxNG™ software must configure the device. Settings are then stored in non-volatile memory on the device (see the AxtraxNG™ Software Manual).

6.3 Modem Network Connection

Access control panels can be controlled from the computer's modem. The modem is assigned from within the AxTraxNG™ software.

Use a modem when the access control panel is too far from the computer to use a serial connection and an alternative RS-232/RS-485 network or TCP/IP network is unavailable.

The following diagram illustrates remote site modem configuration with AC-425.



Figure 22: Remote Site Modem Configuration



Note:

For more information on modem connections, refer to the MD-N33 User Manual and the AxTraxNG™ Software Manual.

6.3.1 Hardware Requirements

- 2 standard telephone cables – RJ11 plugs in both sides
- Crossed 9-pin RS-232 cable (female jack on both sides)
- Rosslare MD-14 (RS-232 to RS-485 converter)
- 2 Rosslare MD-N33 (modem to serial gateway)
- Rosslare AC-425 panel

6.3.2 Prerequisites

Before performing permanent modem installations, the modem that will be connected to the panel must be initialized from the computer running the AxTraxNG™ software.

6.3.3 Computer Connections

The MD-N33 must connect to the computer via a serial port.

To connect to the PC:

1. Connect a 9 VDC adapter to the first MD-N33. Make sure that the power LED (red) is on.
2. Connect the PC using an available COM port to the MD-N33 with a **crossed 9-pin RS-232 cable**.
3. Connect the MD-N33's RJ11 jack to the telephone line using the telephone cable.

6.3.4 AC-425 Panel Connections

1. Connect a 9 VDC adapter to the second MD-N33. Make sure that the power LED (red) is on.
2. Connect the MD-N33's RJ11 jack to the telephone wall mount using the telephone cable.
3. Connect the MD-N33 DB9 female jack to the MD-14 DB9 female jack.
4. Connect the AC-425 RS-485 outlet to the MD-14 4 wires cable. Make sure the J1 switch (on the AC-425) is set to RS-485 Mode.

Appendix. A Limited Warranty

ROSSLARE ENTERPRISES LIMITED (ROSSLARE) TWO-YEAR LIMITED WARRANTY is applicable worldwide. This warranty supersedes any other warranty. ROSSLARE'S TWO-YEAR LIMITED WARRANTY is subject to the following conditions:

Warranty

Warranty of ROSSLARE'S products extends to the original purchaser (Customer) of the ROSSLARE product and is not transferable.

Products Covered By This Warranty and Duration

ROSSLARE ENTERPRISES LTD. AND/OR SUBSIDIARIES (ROSSLARE) warrants that the AC-425 Access Control Panel is free from defects in materials and assembly in the course of normal use and service. The warranty period commences with the date of shipment to the original purchaser and extends for a period of 2 years (24 months).

Warranty Remedy Coverage

In the event of a breach of warranty, ROSSLARE will credit Customer with the price of the Product paid by Customer, provided that the warranty claim is delivered to ROSSLARE by the Customer during the warranty period in accordance with the terms of this warranty. Unless otherwise requested by ROSSLARE representative, return of the failed product(s) is not immediately required.

If ROSSLARE has not contacted the Customer within a sixty (60) day holding period following the delivery of the warranty claim, Customer will not be required to return the failed product(s). All returned Product(s), as may be requested at ROSSLARE'S sole discretion, shall become the property of ROSSLARE.

To exercise the warranty, the user must contact ROSSLARE to obtain an RMA number after which, the product must be returned to the Manufacturer freight prepaid and insured.

In the event ROSSLARE chooses to perform a product evaluation within the sixty (60) day holding period and no defect is found, a minimum US\$ 50.00 or equivalent charge will be applied to each Product for labor required in the evaluation.

ROSSLARE will repair or replace, at its discretion, any product that under normal conditions of use and service proves to be defective in material or workmanship. No charge will be applied for labor or parts with respect to defects covered by this warranty, provided that the work is done by ROSSLARE or a ROSSLARE authorized service center.

Exclusions and Limitations

ROSSLARE shall not be responsible or liable for any damage or loss resulting from the operation or performance of any Product or any systems in which a Product is incorporated. This warranty shall not extend to any ancillary equipment not furnished by ROSSLARE, which is attached to or used in conjunction with a Product, nor to any

Limited Warranty

Product that is used with any ancillary equipment, which is not furnished by ROSSLARE.

This warranty does not cover expenses incurred in the transportation, freight cost to the repair center, removal or reinstallation of the product, whether or not proven defective.

Specifically excluded from this warranty are any failures resulting from Customer's improper testing, operation, installation, or damage resulting from use of the Product in other than its normal and customary manner, or any maintenance, modification, alteration, or adjustment or any type of abuse, neglect, accident, misuse, improper operation, normal wear, defects or damage due to lightning or other electrical discharge. This warranty does not cover repair or replacement where normal use has exhausted the life of a part or instrument, or any modification, abuse of, or tampering with the Product, if Product disassembled or repaired in such a manner as to adversely affect performance or prevent adequate inspection and testing to verify any warranty claim.

ROSSLARE does not warrant the installation, maintenance, or service of the Product. Service life of the product is dependent upon the care it receives and the conditions under which it has to operate.

In no event shall ROSSLARE be liable for incidental or consequential damages.

Limited Warranty Terms

THIS WARRANTY SETS FORTH THE FULL EXTENT OF ROSSLARE WARRANTY.

THE TERMS OF THIS WARRANTY MAY NOT BE VARIED BY ANY PERSON, WHETHER OR NOT PURPORTING TO REPRESENT OR ACT ON BEHALF OF ROSSLARE.

THIS LIMITED WARRANTY IS PROVIDED IN LIEU OF ALL OTHER WARRANTIES. ALL OTHER WARRANTIES, EXPRESSED OR IMPLIED, INCLUDING WITHOUT LIMITATION, IMPLIED WARRANTIES OF MERCHANTABILITY AND FITNESS FOR A PARTICULAR PURPOSE, ARE SPECIFICALLY EXCLUDED.

IN NO EVENT SHALL ROSSLARE BE LIABLE FOR DAMAGES IN EXCESS OF THE PURCHASE PRICE OF THE PRODUCT, OR FOR ANY OTHER INCIDENTAL, CONSEQUENTIAL OR SPECIAL DAMAGES, INCLUDING BUT NOT LIMITED TO LOSS OF USE, LOSS OF TIME, COMMERCIAL LOSS, INCONVENIENCE, AND LOSS OF PROFITS, ARISING OUT OF THE INSTALLATION, USE, OR INABILITY TO USE SUCH PRODUCT, TO THE FULLEST EXTENT THAT ANY SUCH LOSS OR DAMAGE MAY BE DISCLAIMED BY LAW.

THIS WARRANTY SHALL BECOME NULL AND VOID IN THE EVENT OF A VIOLATION OF THE PROVISIONS OF THIS LIMITED WARRANTY.

Appendix. B Technical Support

Asia Pacific, Middle East, Africa

Rosslare Security Products
Headquarters
905-912 Wing Fat Industrial Bldg
12 Wang Tai Road,
Kowloon Bay Hong Kong
Tel: +852 2795-5630
Fax: +852 2795-1508
support.apac@rosslaresecurity.com

United States and Canada

1600 Hart Court, Suite 103
Southlake, TX, USA 76092
Toll Free: +1-866-632-1101
Local: +1-817-305-0006
Fax: +1-817-305-0069
support.na@rosslaresecurity.com

Europe

Global Technical Support &
Training Center
HaMelecha 22
Rosh HaAyin, Israel 48091
Tel: +972 3 938-6838
Fax: +972 3 938-6830
support.eu@rosslaresecurity.com

South America

Presbitero Actis 567 Of. 31 San
Isidro
Buenos Aires, Argentina 1642
Tel: + 54 11 5273 6383
Fax: +54 11 4763 6505
support.la@rosslaresecurity.com

India

Rosslare Security India Ltd.
707, High Land 4,
Akurli Road,
Lokhandwala Township,
Kandivali (East),
Mumbai – 400101
Tel: +0091 22 2966 1130
Fax: +0091 22 2966 1130
support.in@rosslaresecurity.com

China

Beijing Office
Room 1408, 14F, Building 315
Huizhong North Road, Chaoyang
District
Beijing, China
Tel: +86 10 64808945
support.cn@rosslaresecurity.com

Shanghai Office

Room K, 19F, Ladoll Building
831 Xinzha Road, Jing'an, District
Shanghai, China
Tel: +86 21 32313299
support.cn@rosslaresecurity.com

Website: www.rosslaresecurity.com

ROSSLARE
SECURITY PRODUCTS

0706-0960432+00

