



ELECTRONIC ENGINEERING LTD.

Serenity™

CONTROL PANEL

Technician's Handbook

PIN 7107960

IMPORTANT NOTICE

All information and data contained in this document is proprietary and confidential. CROW Electronic Engineering Ltd. shall not be liable, in any event, for any claims for damages or any other remedy in any jurisdiction whatsoever, whether in an action in contract, tort (including negligence and strict liability) or any other theory of liability, whether in law or equity including, without limitation, claims for damages or any other remedy in whatever jurisdiction, and shall not assume responsibility for patent infringements or other rights to third parties, arising out of or in connection with this document.

Further, CROW Electronic Engineering Ltd. reserves the right to revise this publication and to make changes to its content, at any time, without obligation to notify any person or entity of such revision changes. These materials are copyrighted and any unauthorized use of these materials may violate copyright, trademark, and other laws. Therefore, no part of this publication may be reproduced, photocopied, stored on a retrieval system, or transmitted without the express written consent of CROW Electronic Engineering Ltd. Any new issue of this document invalidates previous issues.

©CROW Electronic Engineering Ltd. 2005. All rights reserved.

Information in this document is subject to change without notice. No part of this document may be reproduced or transmitted in any form or by any means, electronic or mechanical, without express written permission of CROW Electronic Engineering Ltd..

Technician Handbook content

SERENITY Installation Guide

Installation Instructions.....	4
--------------------------------	---

How to use this handbook

Touch Panel structure description	8
Keypad Function + Alphanumeric Keys.....	9
Table 1: Keypad keys description.....	9
Table 2: Main screen buttons and symbols description	10
Table 3: Alarm/Trouble Graphic Symbols.....	11
Using Keypad Helpful Tips.....	13

Control Panel Programming Types

Local Configuration Mode.....	15
Quick Programming Mode	17
Installer Program Mode.....	20
User Programming Mode.....	21
End User Permissions Programming.....	21

Serenity Quick Programming Guide

Quick programming recommended steps list	23
--	----

Setting of Zone Configuration

.....	27
-------	----

Installation summary tables

All program addresses list	29
----------------------------------	----

SERENITY Installation Guide

This Installation manual is a part of manuals set. Please refer to technician manual for configuration of the panel.

1. Warnings

This product is designed for indoor use only. Read carefully all manuals before installing the product.

2. Connection Diagram

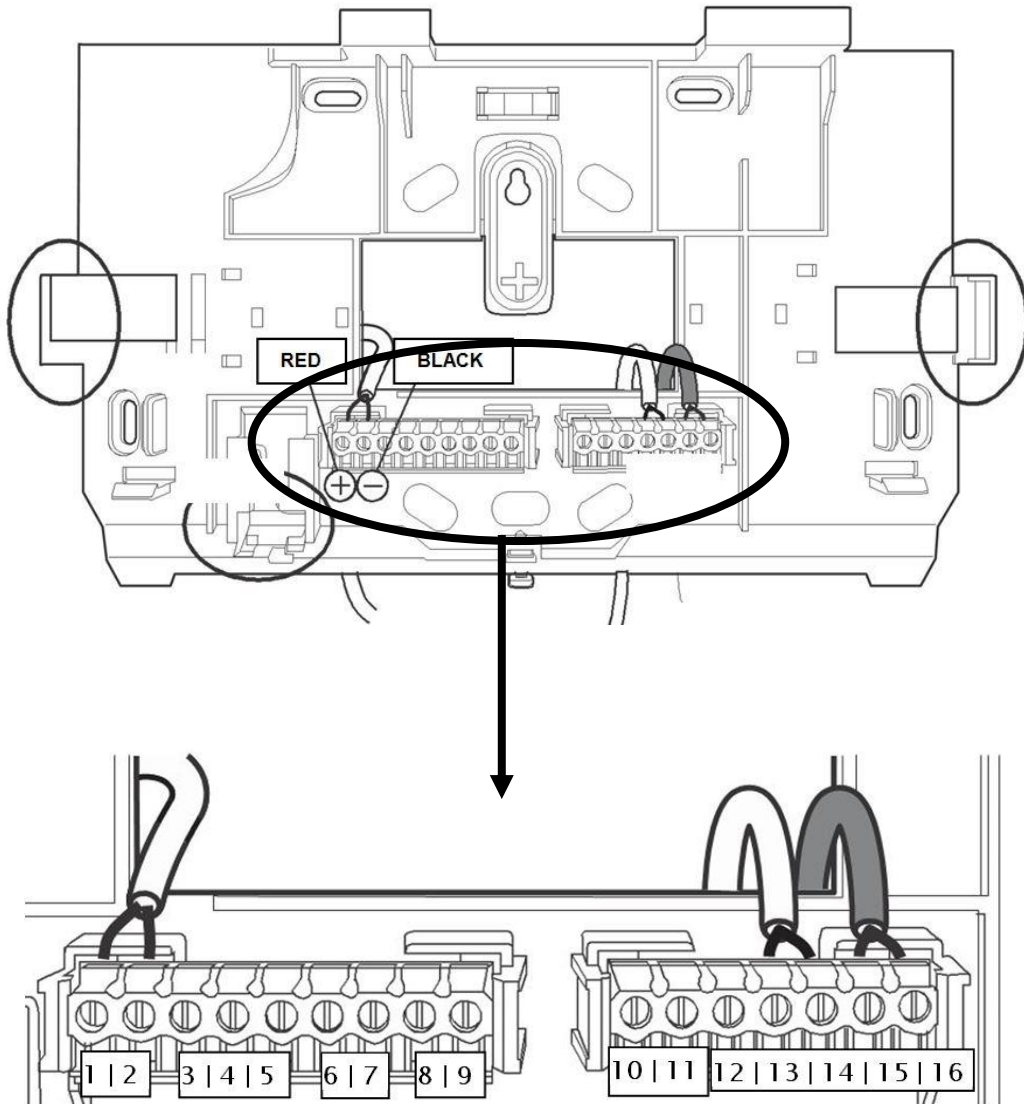

3. Connection Diagram

1	Connect the RED wire of the power adapter (supplied)
2	Connect the BLACK wire of the power adapter (supplied)
3	Zone 31 wire connection
4	Common connection for wired Zone 31 & Zone 32
5	Zone 32 wire connection
6	Wire connection for "Output 3"
7	Wire connection for "Output 2"
8	Positive 12V voltage output (for external devices)
9	Negative 12V voltage output (for external devices)
10	"High" CAN BUS connector
11	"Low" CAN BUS connector
12	Ground connection
13	Phone Line IN.
14	
15	
16	Phone Line OUT

4. Panel Mounting

Unscrew the bracket from the panel

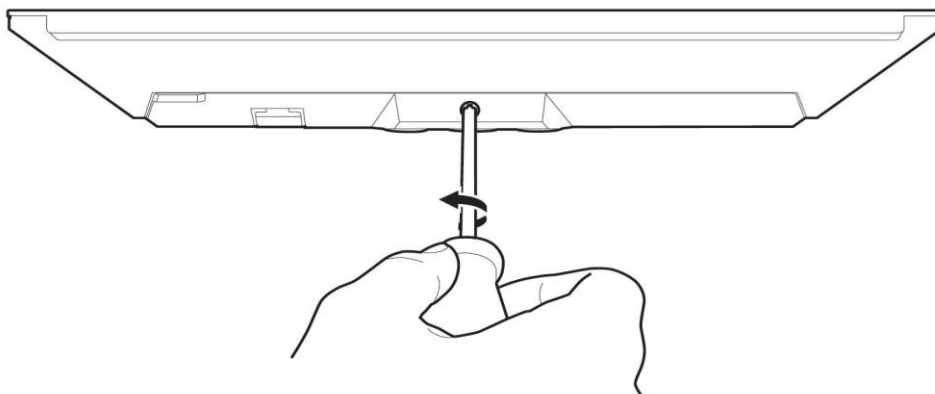

Lift the two notches located on the both sides of the bracket

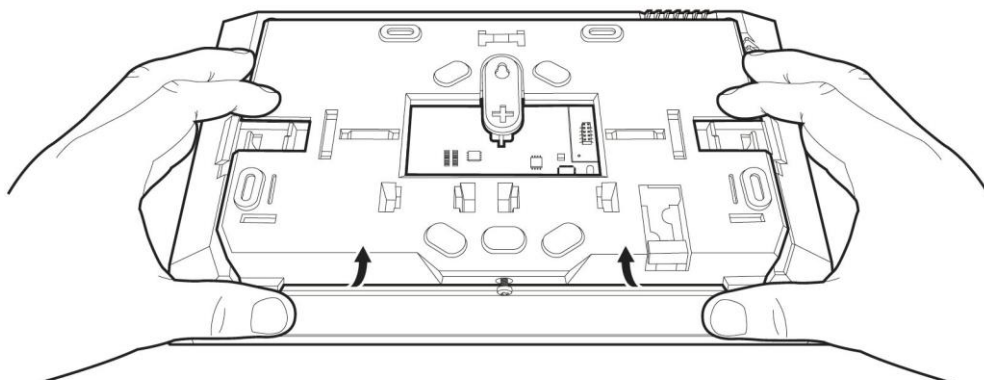

Remove the bracket from the panel

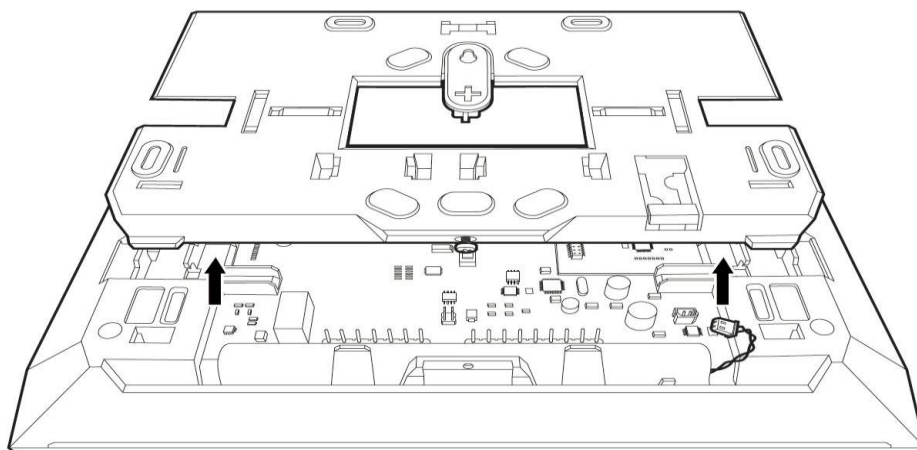

Connect wires into terminal blocks according configuration requirements (see "Connection Diagram") and screw the bracket on the wall.

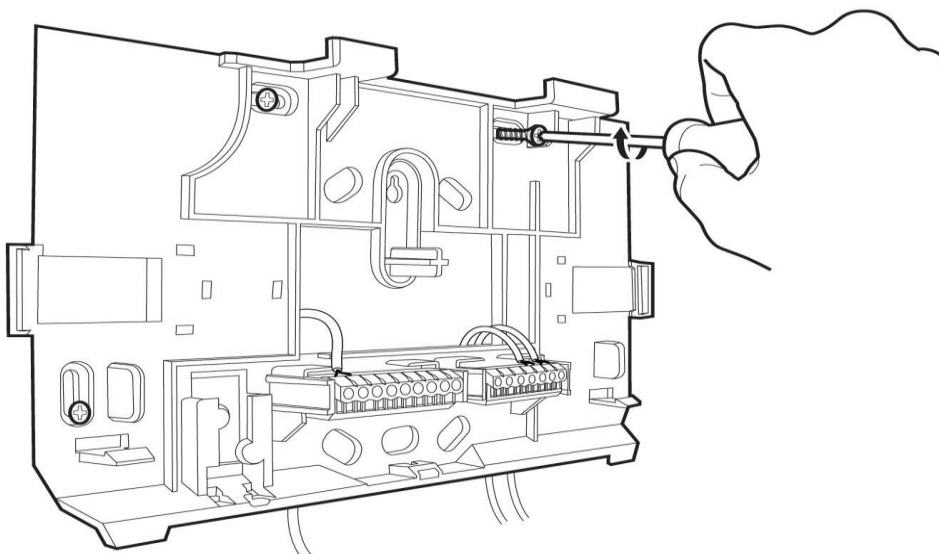

Once all connections are made, connect the battery and mount the panel on its bracket.

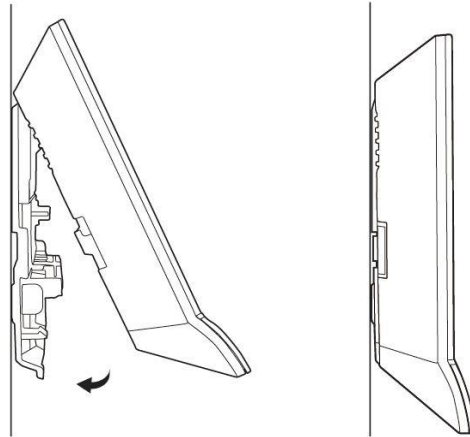

Screw the bracket to the panel.

4. Rear View

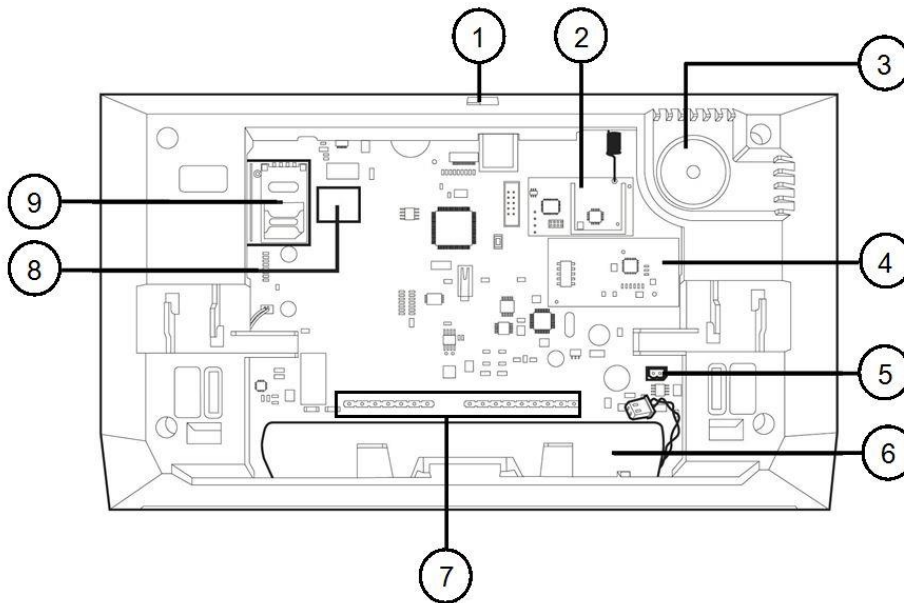

1	USB Port (USB cable supplied)
2	Wireless Radio Module
3	Internal Piezo Sounder
4	RFID Module
5	Battery Connector
6	NI-MH battery Back-up (supplied)
7	Wires connection
8	Ethernet Port (RJ45 cable supplied)
9	GSM/GPRS Module (SIM card not included)

How to Use this Handbook

The following program summary is an abridged version of the Installation Guide, describing the panel program definitions and command addresses. It is intended as a quick guide for finding a program address and entering parameters rapidly. Enter the installer programming mode by using the keypad numerical keys, or by the main menu Display, using the touch panel buttons, and select from the drop list the required programming mode, then use the buttons on the touch panel screen (see picture 1 & picture 2) to search the required menu, and to define the system's parameters. The program addresses are in numerical order, making them easy to find.

Integrated touch panel structure description

Picture 1

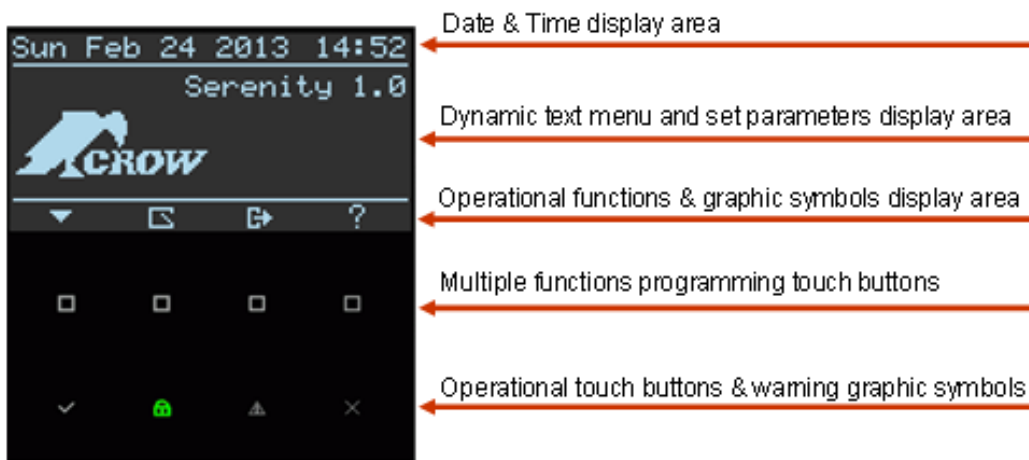

Picture 2

Example 1: Main display Buttons/symbols and Keypad keys (see table 1 & table 2)















Important Note: Multiple programming function touch buttons (above marked in red) change functionality according to menu level. Functionalities are displayed on status symbols display area.

Keypad Function + Alphanumeric Keys

These keys are used to arm the system, enter commands to alter system settings, view status events, scroll through the history events and more.

In addition the keys are used to enter codes, initiate Emergency and used for programming. Please review the next 2 tables table 1 and table 2.











Table 1: Keypad Keys Description

Keys	Description
1,2,3....0	Used for insertion of numbers or letters, key no.1 can be also used for creation actions such as <space >, (+)and (.)
	The P key is used for: 1. Entering programming mode (e.g. P00000E) 2. Dot (.) symbol 3. Entering a command address (e.g. P1E) P=program E=ENTER
	ENTER key
	The A key-used for ARM - pre-programmed
	The B key-used for zone STAY ARM action - pre-programmed
	1.The C key-used to Bypass zones- pre-programmed 2. Can be used to check all boxes for specific parameter by one press.
	1. The D key-used to enter to memory display - pre-programmed. 2.Delete input, and deselects all boxes in an open parameter by one press.
	A "Fire" alarm will be generated if "A" & "B" keypad keys are pressed simultaneously 
	A "Medical" alarm will be generated if "B" & "C" keypad keys are pressed simultaneously 
	A "Panic" alarm will be generated if "C" & "D" keypad keys are pressed simultaneously 
	The A...B...C...Z letters used for editing names and words

NOTE: A, B, C and D are programmable keys, (see command address P114). Can be programmed by entering P00000E and entering P114E or from main menu → programming → Keypads → function buttons

NOTE: See page 09 for helpful tips and examples on how to use the keypad to quickly select specific number from multiple choices such as zones, outputs, users and more.

Table 2: Main Screen Buttons & Symbols Description

Button/ Graphic indication	Description
	ENTER and save action touch button
	ARM OR DISARM Touch Button and Disarm status indication light.
	Alarm/troubles status display Touch Button , and Warning alert indication
	ESC or EXIT touch button
	View of A,B,C, and D keys function
	Output Control function and status view
	View Open Zones
	Main Menu List
	Executable Touch button
	ARM/Disarm status indication light

Important Note: The <Lock> and <A> keys can DISARM only during Exit Delay.

Control Main Menu Commands

Press on the Main Menu Button  and review all control main menu levels

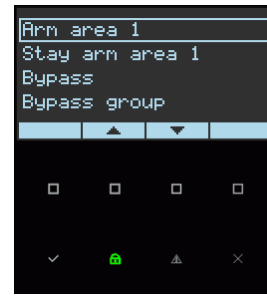
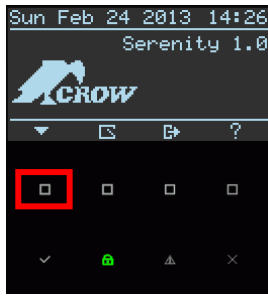

By default the control menu has the following commands list:

- Mmemory
- Arm area 1
- Stay arm area 1
- Bypass
- Bypass group
- Local configuration
- Quick Programming
- Dial phone number
- Voice mail
- Active time zones

Customizing the Main Menu Level List





The installer allows customizing the control menu commands list and adapting its commands and behaviour to the requirements of the particular user per each keypad.























In order to perform the commands customization list, installer has two options:







1. **Programming Mode --> Keypads --> Control Menu**
2. **Using command Address P113E** (see description in installation summary tables chapter in this guide).

Important Note: Voice mail message record time is 2 Min. total

Table 3: Alarm/Trouble Graphic Symbols

Alarm Symbols Display		Description
Main Display screen	Alarm Status view screen	
		Flashing Symbol –Exit delay Time Stable Symbol - AREA is in ARM state
		AREA is in STAY Armed state
		Flashing Symbol - indicates Critical Alarm Stable Symbol - indicates Trouble alarm
		Open Zone

		Zone Tamper Open or Low Battery or zone sensor-watch
		Main Power Fail
		Fuse Fail
		Low Battery (panel)
		CAN BUS Fail
		Ethernet Fail
		GSM/GPRS Fail
		Communication Fail
		Panel Tamper
		RF Jamming
		Radio Zones Low Battery
		Pendant low battery
		AREA is not ready – the number 1 indicates AREA number 1
		Zone Tamper
		Output Tamper
		Output Low Battery
		Output Monitor Fail
		Ten code attempts
		Area 4 Armed
		Zone Bypass
		Alarm in Arm Mode
		EX. Open Zone in Area 4

		Zone Missing
		Time Zone Password active Indication
		System date and time not set
		C.P is connected to Cloud
		C.P is controlled by TCP/IP , USB or Serenity connect Application remote connection
		C.P is controlled by PSTN or GSM Remote connection
		C.P is controlled by SMS Remote connection

Audible Signals

When the keypad is used to activate or deactivate the different functions it emits different audible beeps. Their meaning is described in the table 4.

Table 4: List of Audible Signals

Sound	Description
Short beep	When a key in the keypad has been pressed.
Triple beeps	For ARM/DISARM/WARNING/STAY operations.
Long beep	For alarms/warning corresponded configuration parameters.
Slow beeping	At arming(start exit delay) and warning (entry delay)
Fast beeping	At the last 5 seconds of arming.

Using Keypad Helpful Tip

Example 1: Select Zone Number



1. Option 1: Installer can use the buttons " + or - " to move between zone numbers

2. Option 2: Installer can use the Keypad keys to move between zone numbers by typing the zone number "08", installer must type two digits

Example 2: Select Output Number

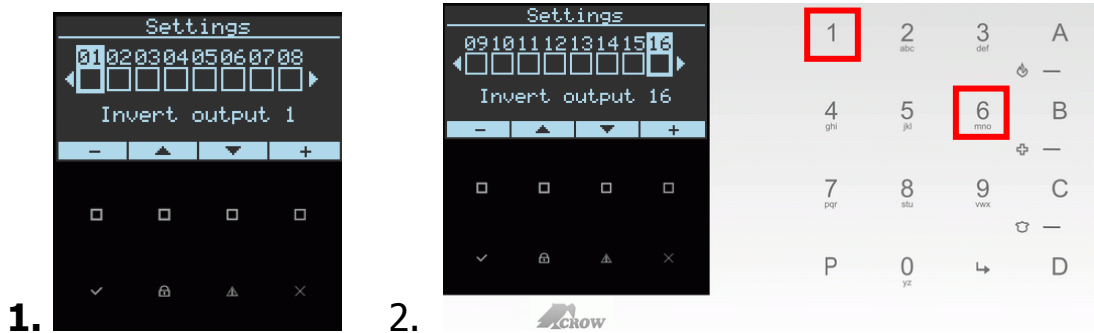

Option 1: Installer can use the buttons " + or - " to move between output numbers

Option 2: Installer can use the Keypad keys to move between output numbers by typing the output number "16", installer must type two digits

Example 3: Select Bypass Zone Number

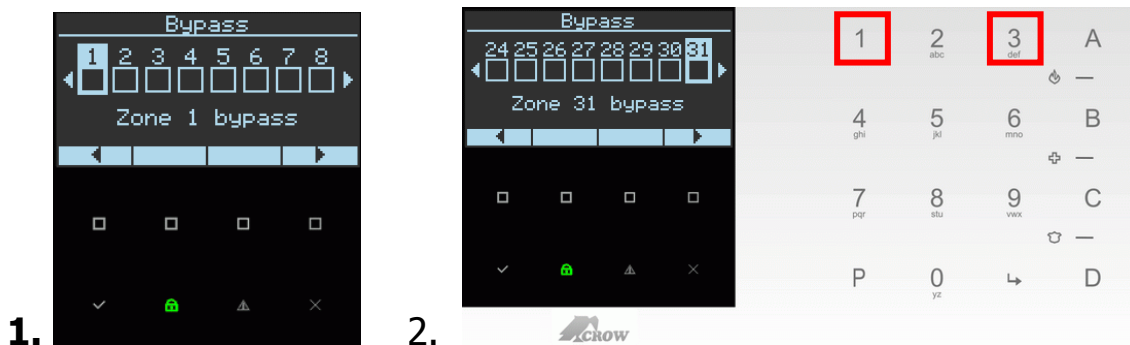

Option 1: Installer can use the buttons " + or - " to move between output numbers

Option 2: Installer can use the Keypad keys to move between output numbers by typing the output number "16", installer must type two digits

AREAS Display

The <View Area number> icon will be displayed on the LCD if you first assign at least one Zone to each of the Areas (P137) and then assign Areas to the keypad (P1097).

To display the Area, use the top right-most button to switch between areas

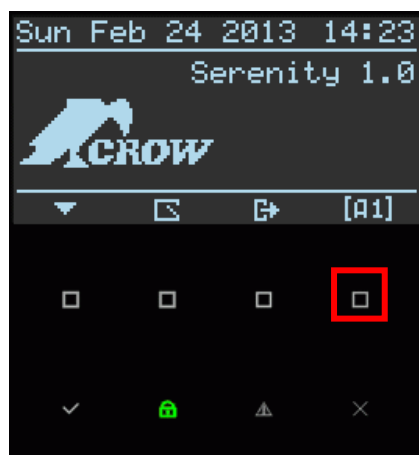

Users and Codes

The system provides up to 32 user codes selectable as either 4 to 8 digits. User 1 is a master user which is assigned 1234 code by default, and has certain permissions to manage the system. User codes are used mainly to arm and disarm the system or to access information that is restricted only to authorized users. Each code can be assigned to one of several authority levels. Moreover, you can program pendant users (keyfob transmitters) that will allow you and the other users to easily arm, disarm and control the system without accessing the panel.

Proximity Tags

The serenity control panel responds to valid proximity tags enrolled to the system. The proximity tag enables user to perform a certain functions without entering user code, for instance, arming, disarming, operating an output on/off. Presenting a valid proximity tag to the control panel which is on disarmed state, will immediately start the arm procedure. Presenting the proximity tag once again will DISARM the system. Installer must note that ARM/DISARM functions are not enabled by default, but if installer learns tags (explained later on in the guide) via quick programming mode or by user mode, ARM/DISARM are enabled by default.

The Next symbol presents the **RFID** location on the Panel



Warning!!!!!!

Note: After factory default the only user in the system is by default user 1 (1234)

Make sure not to delete it before enter new password or learn RMT

in addition mark at least one of the users (password user) as keypad user.



Avoid of assigning user 1 as an output code

PROGRAMMING TYPES

There are 4 different programming types:

1. Local Configuration
2. Quick Programming
3. Installer Program Mode
4. User Program mode

The first 2 (1, 2) types are accessible from Main Menu touch button on the main display of the panel screen (see pages 10-11), the third and fourth types (3, 4) are accessible from keypad keys, refer to the next pages and learn about all 4 programming types and login options.

Note: Use the   buttons to move up and down to select the required programming type, and then use the **Enter** touch button

1. Local Configuration – contains the following functions:

- **Language**
- **keypad Sound**
- **Backlight** (screen and keypad backlight)
- **Microphone** (microphone sensitivity)
- **Speaker** (speaker volume)

How to enter to the Local Configuration mode

1. Press on the Main Menu button of the main panel screen

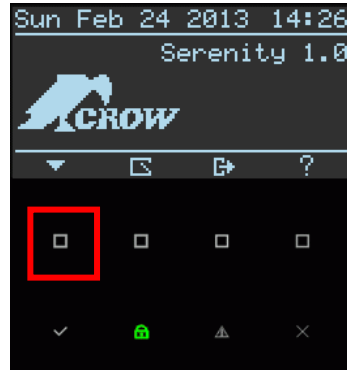

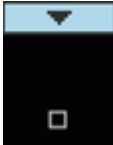
2. Use the  button to scroll down until the desired option **local Configuration** mode is displayed

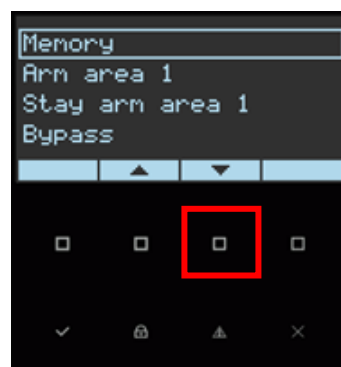

Note: The Arm area 1 is displayed by default, each of the other areas' options should be displayed respectively when you change the <view area number> in the main menu to the requested area.

3. Press on the Enter button

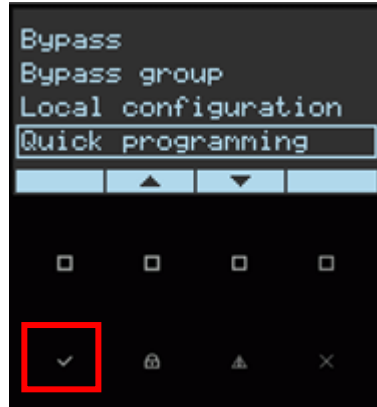

4. Use the scroll buttons to select the required function

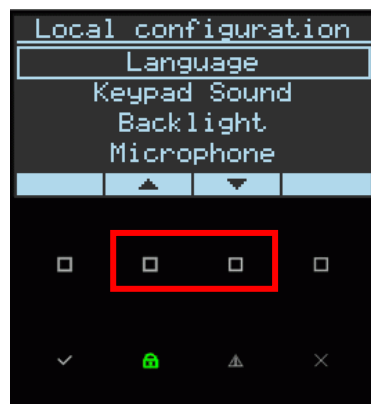

5. Press on the Enter button



6. Select the required language and press the Enter button

2. Quick Programming –

This programming mode is used for a rapid and focused programming of the panel. Further on is a list of the functions available in this programming mode.

For more details on the parameters below, refer to installation summary table section in this manual, you can easily find the command description by using the Command number which appears in command number column in this page.

Note: if this level is used for the first system configuration, it is recommended to use the installer mode after that.

Parameter

1. **Installer code.**
2. **System date and time.**
3. **Report channels type**-> Choose
CID PSTN or CID GSM or SIA PSTN or SMS or
Voice message PSTN, Voice message GSM.
4. **Report channels phone number
Or server IP addresses** 1-4.
5. **Backup channels** 1-4.
6. **Area 1 acc numbers CH** 1-4.
7. **Area 2 acc numbers CH** 1-4.
8. **Area 3 acc numbers CH** 1-4.
9. **Area 4 acc numbers CH** 1-4.
10. **Area names** 1-4.
11. **Area exit delay time** 1-4.
12. **Learn radio zone** 1-32.
13. **Exit Delay zone** 1-32.
14. **Stay mode zone** 1-32.
15. **Zone names** 1-32.
16. **Zone 1-32 assigned to area 1.**
17. **Zone 1-32 assigned to area 2.**
18. **Zone 1-32 assigned to area 3.**
19. **Zone 1-32 assigned to area 4.**
20. **Zone entry delay time** 1-32.
21. **User names** 1-4.
22. **User codes** 1-4.
23. **Learn Pendant user** 1-4.
24. **Learn user 1-4 Access tag.**
25. **User 1-4 assigned to area 1.**
26. **User 1-4 assigned to area 2.**
27. **User 1-4 assigned to area 3.**
28. **User 1-4 assigned to area 4.**
29. **Remote access password.**
30. **Zone walk test.**

Note: Installer password is required for this level (please use the keypad to insert the password). Default password is 000000 (6 zeros).

How to enter to the Quick Programming mode

1. Press on the Menu button of the main panel screen

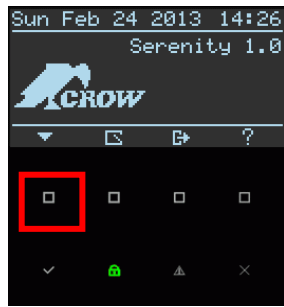

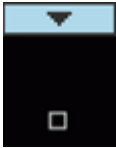
2. Use the button  to move down until the desired option **Quick programming** mode is displayed

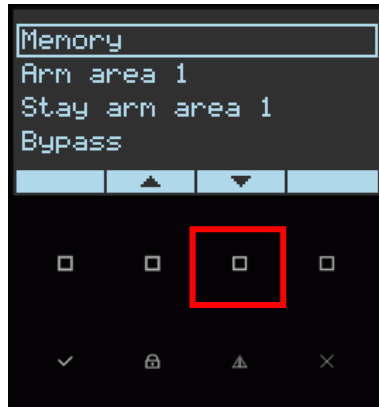

3. Press on the Enter button

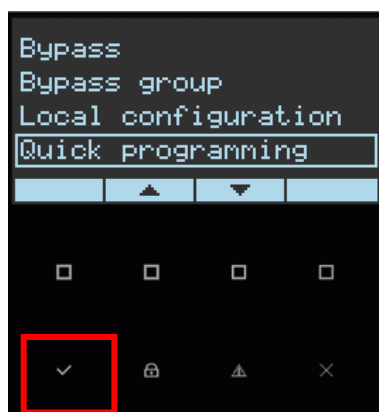

4. Insert the installer password and press on the 'Enter' button

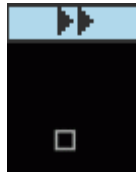
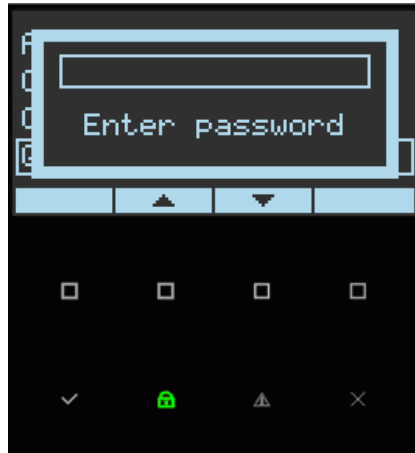

5. Use the touch button  to move through all Quick programming menu

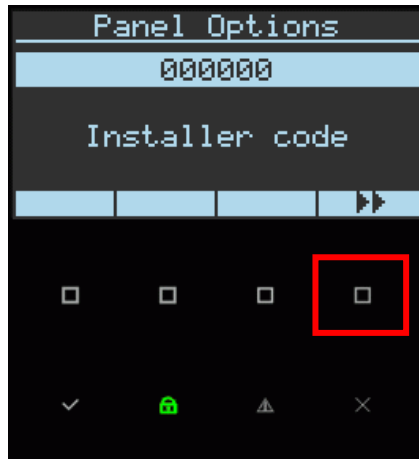

3. Installer Program Mode – This programming mode is the full programming version mode and it is accessible from keypad keys.

Note: You can find the full programming address in this guide on "installation summary tables" chapter, page no. 33

How to Enter to the Programming Mode





To enter Installer Programming mode

- To Enter installer programming mode by using the keypad :
Press **P<000000>Enter** (notice : P=Program E=Enter)

Note: Default installer password is 6 zeros (000000)

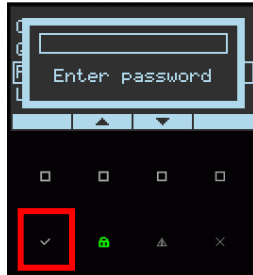
1. Insert the installer password and press on the enter button



2. Use the buttons  to select the required function and programming level

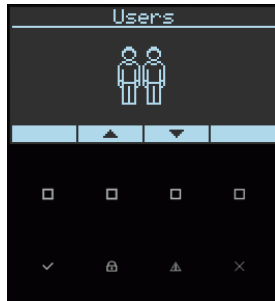

4. **User Programming Mode** – A pre-programmed level which is for programming level of end user (User mode), and it is restricted to certain programming actions which will be described on the next page. Access to this level is allowed from: a) A command from keypad keys or b) from Main menu (if enabled). All programming actions (User program mode) permissions are enabled for **USER 1** (code 1234) by default, any other user permissions should be enabled by the installer.

User 1 is a super user according to P22 (User can change all code).
for regular user not all screens are available.

User programming access options

1. Insert a syntax command From Keypad keys: P<user code>E (e.g. **P1234E**)

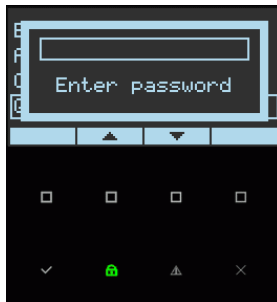

If the 'Programming' level was enabled from Keypads level by the installer:

2. From Main Menu→ Programming→Enter→Insert User Code (1234)



End User Permissions Programming

Default permissions for User 1

1. **Users**->User setting->select User # code 1-32. (User 1 code: 1234)
 - >User name 1-32.
 - >Time zone assignment-> User 1 controlled by time zone 1-8
 - > Permissions->User 1 can allow access to Installer.
 - > Pendants ->Learn pendent 1-32
 - >Find pendent
 - >delete user pendent 1-32.
 - > Access tag ->Learn user tag 1-32
 - >Find access tag
 - >delete user tag 1-32.
2. **Outputs**->radio output->Learn radio output 1-16.
 - >Find radio output.
 - >delete radio output 1-16.
3. **Clock and timers**->System date and time->
 - >System date and time
 - > Daylight saving
 - >GMT zone->Date format->
 - >European DD.MM.YYYY
 - >American MM.DD.YYYY
4. **Time zones**->Settings->Time zone start 1-8
 - >Time zone end 1-8.
 - >Time zone 1-8 day.
 - >Time zone password 1-8.
 - >Holidays 1-8.->Area assignment->Time zone 1-8 assigned to area 1-4.
 - >Output assignment->Time zone 1-8 assigned to output 1-16.
 - >User assignment->User 1-64 controlled by time zone 1-8.
5. **Zones**->Radio zones->Learn radio zone 1-32.
 - >Find radio zone.
 - >Delete radio zone 1-32.
6. **Report channels**->Settings-> channel 1-8 phone number
7. **Communication**->Remote access ->
 - > Remote access password.
 - > Remote access only if disarmed.
 - > Enable direct remote access.

-
-
8. **Misc** ->Panel options ->direct access to config for installer.
- >Voice guide ON/OFF
 - > Control panel title.
- > User options->Hide user codes from installer.
- > Voice mail at disarm.
- >diagnostic->battery voltage.
- >Zone walk test.
 - >RSSI test.
 - >GSM module info.
 - >Ethernet module info.
 - >Manual test connect 1-8 ch.

Serenity Quick Programming Guide

The default settings of this panel have been chosen to allow the system to be up and running with a minimum of programming. As a result, there are normally only a handful of program definitions that need to be changed to get the system fully functional.

Thinking of the immediate needs of the customer, we created the "Quick Programming" as a way to quickly set up the Serenity system.

Note: Quick programming menu covers selected parts of the programming options in the Serenity. To access all options, you will mostly need Installer mode (for more details, see the "Installation Summary Tables" section of the guide)

Note: you can always return the system to factory default from installer programming level (see address P340E)

Programming the Unit

Important Notice: Installer can choose whether he/she wishes to use the **quick programming** through the main menu as described previously in this manual (see **How to enter to quick programming mode** on page 19) or to use the address command directly as will be shown in the "Installation Summary Tables" section. Installer may use the following recommended steps sequence or can select specific requested steps according the installation type.

!!!!!! Note: By default there are no detectors assigned or learned in the control panel, so any attempt of arming the system will be denied until a detector is learned

Quick Programming mode: Main menu → Quick Programming → 000000 → Enter

Step 1: Program the Installer Code

Address	Description	Default
P310E	Installer Code - This code is used to enter full Installer Programming mode. The default installer code is 000000. The Installer Code must be between 4-8 digits in length if parameter is enabled in (P327)	The default installer code is 000000

Step 2: Set the System Date & Time

Address	Description	Default
P120E	System Date - The Real Time Clock controls the Time-zones, the timing of automatic test connections and is used to Time and Date stamp the events in the Event Buffer. Ensure this is set correctly at the time of installation so that the functions affected by it will work properly. The clock is programmed in 24 hour format (e.g. 00:00-23:59)	Disable

Step 3: Report Channels Type

Installer should choose and enable the report channel type

Address	Description	Default
P195E	CID PSTN - Set channel type as CID PSTN. Need to set PSTN enabled to use this type of channel. Default assignment: channels 1,2 - ContactID PSTN, channels 3,4, - voice message PSTN, channel 5, 6 - SMS, channel 7 - TCP/IP and channel 8 - GPRS.	(see Description)

Address	Description	Default
P196E	CID GSM - Set channel type as CID GSM. Need to set PSTN enabled to use this type of channel. Default assignment: channels 1,2 - ContactID PSTN, channels 3,4, - voice message PSTN, channel 5, 6 - SMS, channel 7 - TCP/IP and channel 8 - GPRS.	CID GSM works if GPRS is disable
P197E	SIA PSTN - Set channel type as SIA PSTN. Need to set PSTN enabled to use this type of channel. Default assignment: channels 1,2 - ContactID PSTN, channels 3,4, - voice message PSTN, channel 5, 6 - SMS, channel 7 - TCP/IP and channel 8 - GPRS.	(see Description)
P198E	SMS - Set channel type as SMS. Need to set PSTN enabled to use this type of channel. Default assignment: channels 1,2 - ContactID PSTN, channels 3,4, - voice message PSTN, channel 5, 6 - SMS, channel 7 - TCP/IP and channel 8 - GPRS.	SMS works if CID GSM is enable
P199E	Voice Message PSTN Set channel type as Voice Message PSTN. Need to set PSTN enabled to use this type of channel. Default assignment: channels 1,2 - ContactID PSTN, channels 3,4, - voice message PSTN, channel 5, 6 - SMS, channel 7 - TCP/IP and channel 8 - GPRS.	(see Description)
P200E	Voice Message GSM - Set channel type as Voice Message GSM. Need to set PSTN enabled to use this type of channel. Default assignment: channels 1,2 - ContactID PSTN, channels 3,4, - voice message PSTN, channel 5, 6 - SMS, channel 7 - TCP/IP and channel 8 - GPRS.	(see Description)

Step 4: Report Channels Phone

Address	Description	Default
P202E	Phone Number or Server Address - Phone Number or Server Address - Can be up to 8 phone numbers (for channels defines as PSTN/GSM/Voice/SMS) or 8 server addresses (for channel defined as TCP-IP/GPRS) or DNS Name. The length is up to 50 characters long (digits only for phone numbers and characters/digits for server address).	Ch-7 and Ch-8 set to panel.crowcloud.com Ch-8 is set to backup Ch-7

Step 5: Backup Channel

Address	Description	Default
P203E	Channel Backup - This channel will be selected if main channel has failed to open connection or deliver a message. Note: A Main channel can directly have only one backup channel. You can indirectly set more than one backup channel by creating a chain of backup channels (For example, Active channel 1 has channel 2 set as backup, channel 2 has channel 3 as backup and so on)	Disable

Step 6: Areas Account Number

Address	Description	Default
P206E	<p>Account Number- - When reporting to a monitoring Station there must be a unique account code programmed to identify the area\s reported.</p> <p>Each area has an account code. The account code is up to 4 characters for all protocols, except SIA and Voice message\SMS (see notes below).</p> <p>Each character can be a number from 0-9 as well as the special characters B, C, D, E & F.</p> <p>Take note that the number must be different than zero (0000 or 000000).</p> <p>NOTE:</p> <ol style="list-style-type: none"> 1. SIA protocol- 6 characters 2. All other protocols – 4 characters 3. You can use the characters 0-9 B,C,D,E,F 4. You don't need an ACC number When channel is programmed as Voice message/SMS protocol 	<p>All Zeros</p> <p>A letter - not in use</p>

Step 7: Area Names

Address	Description	Default
P93E	Area Name - Enter the Area name, up to 16 characters	" Area #"

Step 8: Area Exit Delay Time

Address	Description	Default
P74E	Exit Delay Time (sec) - Each Area can have its own exit delay time. The delay can be programmed from 1-255 seconds in one second increments. If the exit delay is set to '0' the panel will be instantly armed.	60

Step 9: Learn Radio Zone

Address	Description	Default
P177E	Learn Radio Zone - Radio detector must be enrolled into the panel before it can be used. pressing of Detector's tamper switch will be used for learning operation	Disable

Step 10: Exit Delay Zone

Address	Description	Default
P132E	Exit delay zone - Zone should be closed for ready to arm. It will not cause an instant alarm if triggered during the exit delay time.	Enable

Step 11: Stay Mode Zone

Address	Description	Default
P130E	Stay mode zone -Zone will cause alarm if triggered when Stay Mode is armed. This feature is normally used for arming just part of the alarm at night time.	Enable

Step 12: Zone Names

Address	Description	Default
P183E	Zone Name - Set the zone name, up to 16 characters	" Zone #"

Step 13: Zone Assign to Area

Address	Description	Default
P137E	Zone assigned to area - This option assigns the Zone to Area. If a Zone is assigned only to one area it will activate if specified area is armed. If zone assigned to more than one area it will activate only when all assigned areas are armed. By default all zones assigned to Area 1.	(see Description)

Step 14: Zone Entry Delay Time

Address	Description	Default
P174E	Armed zone entry delay time (sec) - Each Zone has its own Entry Delay time when in the Full Armed State. The delay can be programmed from 0-9999 seconds in one second increments. If the entry delay is set to 0 the zone will be an instant zone	20 sec for zones 1 & 2

Step 15: User Names

Address	Description	Default
P2E	User Name - Set the user name. Enter name up to 16 characters	"user #"

Step 16: User Codes

Address	Description	Default
P1E	User Code Set the user code (password). Enter user code (4-8 digits)	Code 1 defaults to 1234. This means that User 1 automatically gets the code 1234

Step 17: Learn Pendant

Address	Description	Default
P27E	Learn pendant - Save new pendant in memory, pressing of Pendant's panic Button will be used for learning operation	Disable

Step 18: Learn Access Tag

Address	Description	Default
P33E	Learn access tag - An Access Tag/Card must be enrolled into the panel before it can be used. The rights for tag or card for each user is defined by options [P36] / [P37] (Arm/Disarm) or [P386] / [P387] (Turns output on/off).	Enable for ARM and DISARM

Step 19: User Assigned to Area

Address	Description	Default
P14E	User Assigned To Area - If a User has this option on, they can Arm/Disarm all zones assigned to Area	All users assigned to area 1

Step 20: Remote Access Password

Address	Description	Default
P236E	Remote Access Password – up to 8 character password for remote pc application access. (randomly number is provided during production)	Enable

Step 21: Walk Test

Address	Description	Default
P343E	Walk Test - This address is used to start walk-test mode while in installer or user program mode. By walking past all of the detectors connected to the system and activating them, the associated zone will latch up at the keypad to allow verification that all zones are working properly. By pressing Enter or Cancel button, walk-test mode will be terminated. The results of the walk-test will be shown on the screen to verify which detectors were triggered during walk-test mode.	Disable

Setting of Zone Configuration

Programming of Zone Configuration, such as Gain Level, Pet Immunity, LEDs Enable, Supervision, and more of the serenity series, will be defined manually by the installer only from programming level.

By Default, all Zone Config screens are not visible, "Zone Config screens" (**P181**) will be visible right after a detector was learned and enrolled into system through "learn radio zone" (**P177**) procedure.

Zone Configuration Screen Examples:

1. PIR Camera Zone Config screens

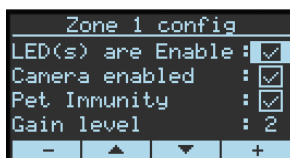
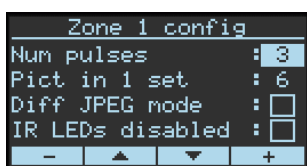



FW2 MAG Zone Config screens

2.

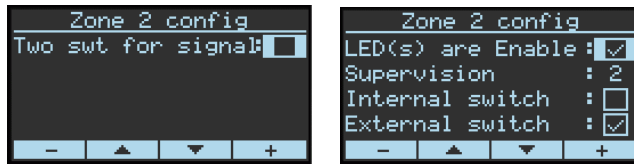

FW2 PIR Zone Config screens

3.



4. FW2 SMOKE Zone Config screens

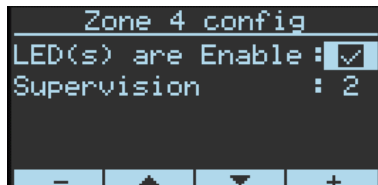

Important Notice: 1. Setting or changing of Zone Configuration will be implemented into the detector configuration in the next event such as Open Zone \Open Tamper \ supervision.

2. For return to default definition after learning, user can enter P180-"Radio zone reset config".

Installation Summary Tables

USERS

	<u>Page No.</u>
User Settings.....	32
User Options.....	32
User Type	32
Area Assignment.....	33
Output Assignment	33
Keypad Assignment.....	33
Time Zone Assignment.....	33
Permissions.....	34
Pendants.....	34
Access Tag.....	35

OUTPUTS

Settings.....	36
Output Type	37
User Assignment.....	37
Time Zone Assignment	37
Keypad Assignment.....	38
Signals to Output.....	38
Timing.....	39
Radio Output.....	39
Output Name.....	40

AREAS

Settings.....	40
Timers and Delays.....	41
Zone Assignment.....	41
User Assignment	41
Keypad Assignment.....	41
Time Zone Assignment.....	42
Report Channel Assignment.....	42
Signals to Outputs.....	42
Beeps to Keypad.....	44
Area Names.....	44

KEYPADS

User Settings.....	44
Area Assignment.....	44
User Assignment	45
Output Assignment	45
Alarms to Output.....	45
Beeps to Keypad.....	46
Radio Keypads.....	47
Control Menu.....	47
Function Buttons.....	47

KEYSWITCH

Settings.....	47
Options.....	47

CLOCK & TIMERS

System Date and Timers.....	48
Date Format.....	48
Timers	48
Delays.....	49

ZONES

Status.....	49
Area Assignment.....	50
Working Mode	50
Options.....	51
Zone Response Time.....	51
Alarms to Output.....	52
Beeps to Keypad.....	53
Delays and Timers.....	54
Radio Zones.....	54
Re-Trigger.....	54
Zone Names.....	55

TIME ZONES

Settings.....	55
Area Assignment.....	56
Output Assignment	56
User Assignment	56

REPORT CHANNELS

Channel Type.....	56
Settings.....	57
Area Account Number Assignment	58
Reporting Options.....	58

COMMUNICATIONS

Remote Access.....	60
Phone Line Options.....	61
PSTN	61
GSM.....	62
TCP-IP.....	62
CUN-BUS.....	62
Contact ID Codes.....	63
SIA Codes.....	63
Voice Message Numbers.....	63
Control Code Number.....	64

MISCELLANEOUS

Chime Control.....	65
Panel Options.....	65
User Options	67
Voice Mail At Disarm.....	68
Diagnostic.....	68
Extender Type.....	69
Extender Options.....	69

1: [Users](#)

1.1: Users/Users Settings

Address	Description	Default
P1E	User Code - Set the user code (password). Enter user code (4-8 digits)	Code 1 defaults to 1234. This means that User 1 automatically gets the code 1234
P2E	User Name - Set the user name. Enter name up to 16 characters	"user #"

1.2: Users/User Options

Address	Description	Default
P3E	User Code can arm all areas assigned at address [P14]	Enable
P4E	User Code can arm Stay Mode for all areas assigned at address [P14]	Disable
P5E	User Code can disarm all areas assigned at address [P14]	Enable
P6E	User Code can disarm Stay Mode for all areas assigned at address [P14]	Enable
P7E	Security Guard User - User Code can arm all areas assigned at address [P14], but may only disarm if the panel is currently armed and in the alarm state	Disable
P8E	Latchkey Mode User - User will arm the alarm in Latchkey Mode. If a user with this option on disarms the alarm no disarm report will be sent via the dialer. If Latchkey Mode is armed and a user with this option off disarms the alarm a disarm report will be sent to alert parents when their children have returned home. Reporting of Latchkey Disarm is enabled at [P229]. If a Voice report is desired the message is assigned at [P284].	Disable
P9E	Code required after access tag - After presenting access tag user has to enter a valid user code	Disable

1.3: Users/User Type

Address	Description	Default
P10E	Keypad User - Codes can be used to Arm/Disarm all or part of the alarm or they can be used to operate outputs for access control purposes. Users can be assigned to keypads and so can outputs so that a User assigned to multiple outputs (which can in turn be linked to doors) can operate only the door assigned to the keypad they are using	Enable
P11E	Pendant User - Radio keys can be used to Arm/Disarm all or part of the alarm or they can operate outputs directly. Unlike user codes, a radio key cannot be assigned to a keypad so if a radio key is assigned to more than one output and the radio key is operated, all of the outputs assigned to the radio key will turn on	Disable

P12E	Access Tag User - Access Tag can be used to Arm/Disarm all or part of the alarm or it can be used to operate outputs for access control purposes.	Disable
P13E	Remote Control User - This option defines user rights for remote control of the control panel via phone line by DTMF control code numbers, via SMS or via WEB-server and smartphone application.	User 1 only

1.4: Users/Areas Assignment

Address	Description	Default
P14E	User Assigned To Area - If a User has this option on, they can Arm/Disarm all zones assigned to Area	all users assigned to area 1

1.5: Users/Output Assignment

Address	Description	Default
P15E	User code turns output on -Any user can be allowed to turn an Output ON. This Function can be used to control external devices via the panel keypad with a User assigned to that Output. Once an Output is turned ON by a User, the Output can turn OFF again automatically if a reset time is assigned to the Output, or it can be turned off by the same user or by a different user with the next program location	Disable
P16E	User code turns output off -Any user can be allowed to turn an Output OFF. This Function can be used to control external devices via the panel keypad with a User assigned to that Output. Once an Output is turned OFF by a User, the Output can be turned on by the same user or by a different user with the previous program location	Disable

1.6: Users/Keypad Assignment

Address	Description	Default
P18E	User can operate at keypad -Any user can be assigned to only operate certain Keypads. This option controls whether a code or access tag User can Arm/Disarm from certain keypads. This option does not restrict users from operating outputs from a particular keypad (this is done at location [P98])	Enable

1.7: Users/Time Zone Assignment

Address	Description	Default
P19E	User Controlled by Time Zone - When the user is controlled by time zone, its keypad code, access tag and pendant deactivated all the time, when the time zone is not started or finished. Only when the time zone is started, the user can perform actions in the system in accordance with its rights as defined by configuration.	Disable

1.8: Users/Permissions

Address	Description	Default
P20E	User can view memory and status - If this option is off, user cannot enter memory view mode, statuses and active time zones.	Enable
P21E	User can change his code and name - When enabled, user can change his own code and name in User programming mode	enabled for all users
P22E	User can change all codes and names - When enabled; "User can change all codes" allows the user to change all user codes and all user names in User programming mode. In addition, it also defines the user as "super-user", which in turn opens up the following options in User Programming Mode: <ol style="list-style-type: none"> 1) Opens up "User # controlled by time zone #" (P19E). 2) Opens up "User can allow access to installer" (P23E). 3) Opens up "Direct access to config for installer" (P313E). 4) Opens up "Hide user codes from installer" (P332E). 5) It lets the user to assign time zones to all 4 areas ("Time zone assigned to area" - P191E, "Time zone stay armed area" - P53E), regardless of the user's area assignment. 6) Allows enable/disable of "Voice guide" (P314E). 7) Allows changing the marking of "Remote access only if disarmed" (P237E). 8) Allows changing the marking of "Enable Direct Remote Access" (P388E). 9) Change marking of "Daylight saving" (P121E) when "User can change the clock" is also enabled. 	User 1 only
P23E	2. User can allow access to installer mode - If a User has this option on, and When "Direct access to config for installer" (P313E) is disabled, the user's code can give access to installer program mode.	User 1 only Available on User Mode only
P24E	User can change phone or address - When enabled, user can access and change the phone number or address of report channels 1-8 in user mode (P202E)" and conduct manual tests of report channels in P348E.	Enable User 1 only
P25E	User can change the clock - When enabled, it allows the user to do the following in User Program Mode: <ol style="list-style-type: none"> a. Change the time and date in the system (P120E). b. When "User can change all user codes and names" is also enabled, to change "Daylight saving" mode (P121E). c. Change GMT (P122E). 	Enable User 1 only
P26E	User can learn radio devices - If a User has this option on, user can access User Programming Mode and Learn a new Radio Key or Wireless Zone Device. The user can also remove radio devices or find what location number a device is stored at.	User 1 only

1.9 Users/Pendants

Address	Description	Default
P27E	Learn pendant - Save new pendant in memory, pressing on Pendant's panic Button will be used for learning operation	Disable
P28E	Find pendant - Find existing pendant in memory	Disable
P29E	Delete pendant - Delete existing pendant from memory	Disable
P30E	Pendant can disarm during alarm only - If this option is on, pendant can disarm the alarm during alarm only. If this option is off, the pendant cannot disarm the panel in any state.	Disable
P31E	Pendant can disarm during entry delay only - If this option is on, pendant can disarm the alarm during alarm only. If this option is off, the pendant can disarm the panel in any state.	Disable
P392E	Pendant Panic Alarm to Output - A Pendant Panic Alarm can be assigned to an Output or multiple Outputs. This can be used to operate an audible or visual alarm connected to the Output	Outputs 1,2,4,5
P32E	Pendant Buttons - Assign function to pendant's button. By default button1 is assigned to Disarm, button2 - Arm, button 3 - Stay arm, button 4 – not in use, button 5 - Panic.	(see Description)

1.10: Users/Access Tag

Address	Description	Default
P33E	Learn access tag - An Access Tag/Card must be enrolled into the panel before it can be used. The rights for tag or card for each user is defined by options [P36] / [P37] (Arm/Disarm) or [P386] / [P387] (Turns output on/off).	Enable for ARM and DISARM
P34E	Find access tag -If you have an Access Tag or Card loaded into the panel but are unsure which location (User #), pressing [P34] while in Program Mode will start 'Find' Mode. Present the Access Tag or Card you wish to find to a proximity reader connected to the panel. If the Tag or Card is in memory the keypad will display the number where the Tag or Card is stored.	Disable
P35E	Delete access tag -If you wish to delete a single Access Tag or Card, entering [P35] and user number while in Program Mode will delete the stored code against that user.	Disable
P36E	Access tag can arm - If this option is on, access tag can arm all areas assigned at [P14]	Enable
P37E	Access tag can disarm - If this option is on, access tag can disarm all areas assigned at [P14]	Enable
P386E	Access tag turns on output - Any user's access tag can be allowed to turn an Output ON. In this case Arm/Disarm functionality for selected tag is not relevant. This Function can be used to control external devices via access tags. Once an Output is turned ON by a User, the Output can turn OFF again automatically if a reset time is assigned to the Output, or it can be turned off by the same user or by a different user with the next program location	Disable
P387E	Access tag turns off output - Any user's access tag can be allowed to turn an Output OFF. In this case Arm/Disarm	Disable

Address	Description	Default
	functionality for selected tag is not relevant. This Function can be used to control external devices via access tags. Once an Output is turned OFF by a User, the Output can be turned on by the same user or by a different user with the previous program location	

2: [Outputs](#)

2.0: Outputs/Settings

Address	Description	Default
P39E	Invert Output -This option is used to invert the normal state of the output. The panel uses open collector transistor switches and the default state of all outputs is off (open). When in alarm the transistor is turned on and the output goes low (0V). The invert option reverses this function.	Disable
P40E	Temporary output Disable - This option allows a technician to select any output/s to be temporarily disabled for one alarm or armed cycle, e.g. by selecting Outputs 1-16 at this location then leaving program mode, outputs 1-16 will not turn on following any alarms. The technician is now free to arm the system to test all monitoring signals without having any internal and/or external alarms activating. When the alarm is reset or disarmed all outputs will return to normal.	Disable
P41E	Lockout Output -This option is used to limit the output to one operation per arming period.	Disable
P42E	Pulse Output on Kiss-off Following Arming - This option will cause the Output to short single pulse when any area is armed and the message has been kissed off by monitoring company.	Disable
P382E	Output Disable During Disarm - This option will cause the Output to be disabled when all areas in DISARM state. It is designed to keep audible alarms silent when the full system disarm, but part of alarms (like Panic or Fire alarm) still turns audible alarms to on regardless of this setting.	Enable
P43E	Disable During Alarm Report Delay -This option will cause the Output to be disabled when the reporting delay is active. It is designed to keep external audible alarms silent when the reporting delay is active (allowing internal alarms to warn that the alarm will be reported to monitoring if not unset) but if the alarm hasn't been reset before the timer expires the external alarm will sound.	Disable
P44E	Mute for 10 sec on key-press if alarm - When the alarm is Armed and activated it can be difficult sometimes to turn the alarm off because you are unable to hear the beeps as you enter you code at the keypad. If this option is turned on the selected output/s will silence (turn off) for 10 seconds on the first button press at any keypad. This should allow easy Disarming of the alarm by a valid User. If the alarm is not turned off within the 10 seconds, the outputs will turn on again.	Disable

Address	Description	Default
	This function will only work once during an Armed cycle and the panel must be Disarmed before it will work again.	
P45E	Enable Output Monitoring- If this option is enabled, the control panel monitors the status of the outputs by voltage level for wired outputs or coming supervision messages for wireless outputs. If disabled - monitoring the state of the outputs will be disabled.	Disable

2.1: Outputs/Output Type

Address	Description	Default
P46E	Steady Output - The output will change its state when an alarm occurs	Enable
P47E	Single Pulse Output - This option produces a single pulse at the output when an alarm occurs (the pulse time is the value programmed at address [P61]).	Disable
P48E	Flash Output - When the output is turned on this option causes the output to flash at a rate set at address [P61] . One use is to flash a lamp during an alarm.	Disable

2.2: Outputs/User Assignment

Address	Description	Default
P1015E	User code turns this output on - Any user can be allowed to turn an Output ON. This Function can be used to control external devices via the panel keypad with a User assigned to that Output. Once an Output is turned ON by a User, the Output can turn OFF again automatically if a reset time is assigned to the Output, or it can be turned off by the same user or by a different user with the next program location.	Disable
P1016E	User code turns this output off - Any user can be allowed to turn an Output OFF. This Function can be used to control external devices via the panel keypad with a User assigned to that Output. Once an Output is turned OFF by a User, the Output can be turned on by the same user or by a different user with the previous program location	Disable

2.3: Outputs/Time Zone Assignment

Address	Description	Default
P1192E	Time Zone Assignment - If a time-zone is assigned to an output it will turn the output on when the time-zone starts and turn the output off when it finishes.	Disable

2.4: Outputs/Keypad Assignment

Address	Description	Default
P1098E	Keypad is linked to Output - A Keypad can be assigned to an Output or multiple Outputs. If a Keypad is not assigned to an Output a User cannot turn that Output On or Off from the Keypad. This feature is useful when using the access control	Enable

Address	Description	Default
	features of the panel, eg a User may be allowed to operate more than one Output with their code but they will be limited to just the Output assigned to the Keypad they are using	

2.5: Outputs/Signals to Output

Address	Description	Default
P49E	Mains Fail to Output - This option is used to assign a Mains Fail alarm to an Output	Disable
P50E	Fuse Fail to Output -This option is used to assign a Fuse Failure alarm to an Output. The on-board fuses are thermally activated. If excessive current is drawn from a fuse it will disconnect the power until the problem is resolved. There are two thermal fuses protecting the various 12v DC outputs	Disable
P51E	Battery Low to Output -This option is used to assign a Battery Low alarm to an Output	Disable
P52E	Monitor output fail to Output -Assigning monitor output fail alarm	Disable
P390E	Output tamper alarm to Output - This option is used to assign an Output tamper alarm to an Output. When output tamper alarm occurs, any output can be turned to on.	Enable for outputs 1,2,4,5
P54E	Communication fail to Output -This option is used to assign a Communication Failure alarm to an Output	Disable
P55E	Radio Zone Supervised Fail to Output -This option is used to assign a Radio Detector Supervisory Fail alarm to an Output	Disable
P56E	System Tamper to Output - This option is used to indication the panel tamper alarm by specified Output. The Output turns to on in arm or stay arm state only.	Enable for outputs 1,2,4,5
P57E	Sensor-Watch to Output -This option is used to assign a Sensor-Watch alarm to an Output. A Sensor-Watch alarm occurs when a detector has not operated within a set period of time	Disable
P17E	Duress Alarm to Output -Duress Alarm [P311] can be assigned to an Output or multiple Outputs. This can be used to operate an audible or visual alarm connected to the Output. A Duress alarm is created when the alarm is Disarmed with the Duress digit preceding a valid User Code	Disable
P58E	Walk Test Pulse to Output - When the panel is in Walk-test Mode, this option assigns a one single pulse (one chirp) to the Output every time a zone is triggered.	Enable for outputs 1,2,4,5
P1059E	Keypad Panic Alarm to Output - A Keypad Panic Alarm (pressing C & D buttons together) can be assigned to an Output or multiple Outputs. This can be used to operate an audible or visual alarm connected to the Output	Enable for outputs 1,2,4,5
P1099E	Keypad Fire Alarm to Output - A Keypad generated Fire Alarm (pressing the A & B) can be assigned to an Output or multiple Outputs. This can be used to operate an audible or visual alarm connected to the Output	Enable for outputs 1,2,4,5

Address	Description	Default
P1100E	Keypad Medical Alarm to Output- A Keypad generated Medical Alarm (pressing the B & C together) can be assigned to an Output or multiple Outputs. This can be used to operate an audible or visual alarm connected to the Output	Enable for outputs 1,2,4,5
P1392E	Pendant Panic Alarm to Output - A Pendant Panic Alarm can be assigned to an Output or multiple Outputs. This can be used to operate an audible or visual alarm connected to the Output	Enable for outputs 1,2,4,5

2.6: Outputs/Timing

Address	Description	Default
P60E	Output Delay Time - The 'On' delay allows the operation of the Output to be delayed by the time programmed at this location. If set to '0' there will be no on delay and the Output will operate the instant it is turned on. The time range is 0-36000 seconds.	0s
P61E	Output Pulse Time - Output Pulse Time affects the time an output turns on when the pulse timer is used on the Output (see [P47], [P48]). The pulse time is in 1/10th second increments so that very quick timing can be achieved. The maximum value that could be assigned to is 36000 which corresponds to 1 hour. The parameter valid for wired outputs only.	20
P62E	Output Reset Time - The Reset time affects the time the output turns on in case of alarm state. The time range is 0-36000 seconds	For outputs 1 and 2, 240 sec, all the rest outputs endless
P63E	Output Chime Time - The Chime Mode time affects the time the output turns on when a Chime Zone is activated. The Chime time is in 1/10th second increments so that very quick timing can be achieved. Min 0 max 36000	20

2.7: Outputs/Radio Output

Address	Description	Default
P64E	Learn Radio Output - Save new radio output in memory	Disable
P65E	Find Radio Output - Find existing radio output in memory	Disable
P66E	Delete Radio Output- Delete existing radio output from memory	Disable
P184E	Output reset config- This function resets to default parameters values which were defined in (P185E) of a radio output.	
P185E	Output config - This function set remotely the radio output parameters such as led on/off, sounder on/off, led and sounder timeouts, etc.	

2.8: Outputs/Output Name

Address	Description	Default
P67E	Output Name - Set output name, up to 16 characters	"output #"

3: [Areas](#)

3.0: Areas/Settings

Address	Description	Default
P68E	Code required to bypass zones - If this option is turned on, the BYPASS button cannot access Bypass Mode directly. To enter Bypass mode the User must press BYPASS CODE ENTER before they can bypass zones	Disable
P69E	Code required to Arm -If this option is turned on, the ARM button is disabled and the panel requires a code to Arm	Disable
P70E	Arm command required before code to set -This option determines if the ARM button must be pressed before a code is entered to Arm an Area	Disable
P71E	Stay command required before code to set stay mode -This option determines if the STAY button must be pressed before a code is entered to Arm Stay Mode	Disable
P72E	Report Arm on Exit Delay -If this option is on the panel will report the Arm/Stay signal to a monitoring station when the exit delay expires. If it is off, the panel will report the arm/stay signal immediately after the system has been armed	Disable
P73E	Use near and verified alarm reporting for all zones -To reduce the possibility of false alarms the panel can require two alarms on different zones within a 45 minute period before a full alarm will be sent. If this option is turned on it applies to all zones assigned to that area. An alarm on a single zone will send a Near Alarm report to the monitoring station. If no further alarms occur within 45 minutes the near alarm timer is reset and a restore is sent for the zone that activated. If the zone that activated is still in alarm when the 45 minute timer expires, a zone bypass for that zone will be sent and the zone will remain bypassed until the area is disarmed. Any new alarms after the timer has expired will send another Near Alarm report. If a second alarm on a different zone occurs within 45 minutes of the Near alarm, an Intrusion Verified alarm report will be sent. This format applies to all protocols except SIA PSTN, Voice message PSTN/GSM.	Disable Note: this feature is not valid for 24 hour zones
P393E	Unable to arm if exit zone is open - If this option is turned on, the system doesn't arm or stay arm the area if one of the low security zones or exit delay zones is still open after the exit delay expired.	

3.1: Areas/Timers and Delays

Address	Description	Default
P74E	Exit Delay Time - Each Area can have its own exit delay time. The delay can be programmed from 1-255 seconds in one	60

Address	Description	Default
	second increments. If the exit delay is set to '0' the panel will be instantly armed.	
P75E	Stay Exit Delay Time - Each Stay Mode Area can have its own exit delay time. The delay can be programmed from 1-255 seconds in one second increments. If the exit delay is set to '0' the panel will be instantly armed.	60
P76E	Delinquency Delay - Each Area can have its Delinquency time. The delinquency time monitors the arm/disarms of each Area. If an Area has not been armed within the set number of days a delinquency report will be sent. Each time an Area is armed the delinquency timer is reset. A value of '0' disables the delinquency monitoring. NOTE: If the default value of '0' is changed at this location (e.g. a value of 10 is entered meaning 10 days), the next time the area is armed a delinquency restore message will be sent via the dialer as a test that the function is operating	Disable

3.2: Areas/Zone Assignment

Address	Description	Default
P1137E	Zone Assigned to Area - This option assigns the Zone to Area. If a Zone is assigned only to one area it will activate if specified area is armed. If a zone is assigned to more than one area, it will activate only when all areas the zone is assigned to are armed. By default all zones assigned to Area 1.	All zones Assigned to Area 1 , (zone 32 Assigned to area 1,2,3,4)

3.3: Areas/User Assignment

Address	Description	Default
P1014E	User Assigned To Area - If a User has this option on, they can Arm/Disarm all zones assigned to Area	all users assigned to area 1

3.4: Areas/Keypad Assignment

Address	Description	Default
P1097E	Keypad Assigned To Area - This option assigns Area to keypads. If a keypad is assigned to one area only it can Arm or Disarm only that area and show states only for this area. If keypad assigned to more than one area, it can be switched to operate specified area and show states. By default all keypads assigned to area 1.	All Keypads assigned to area 1,2,3,4

3.5: Areas/Time Zone Assignment

Address	Description	Default
P1191E	Time Zone Assigned to Area - If P166E, P167E and P168E are set (see 8.0), and this option is turned on then the Area can be automatically armed or disarmed by a time-zone/s. You can assign more than one time-zone to each Area. If assigning multiple time-zones you should insure that they do not overlap as this could cause confusion. A Time-zone would typically be	All time zones Assigned to Area 1,2,3,4

Address	Description	Default
	0830-1700 Monday-Friday. An area will turn on when the Time-zone ends (e.g. 1700) and turn off when a Time-zone starts (e.g. 0830)	

3.6: Areas/Report Channel Assignment

Address	Description	Default
P1206E	<p>Account Number - When reporting to a monitoring Station there must be a unique account code programmed to identify the area\s reported.</p> <p>Each area has an account code. The account code is up to 4 characters for all protocols, except SIA and Voice message\SMS (see notes below).</p> <p>Each character can be a number from 0-9 as well as the special characters B, C, D, E & F.</p> <p>Take note that the number must be different than zero (0000 or 000000).</p> <p>NOTE:</p> <ol style="list-style-type: none"> 1. SIA protocol- 6 characters 2. All other protocols – 4 characters 3. You can use the characters 0-9 B,C,D,E,F 4. You don't need an ACC number When channel is programmed as Voice message/SMS protocol 	Disable

3.7: Areas/Signals to Outputs

Address	Description	Default
P77E	Arm Indication to Output - For monitoring purposes an Arm indication can be assigned to an Output. This could be used to start a video recorder or similar device. Each Area can have a separate arm indication assigned to a different output if required	Output 3 only
P78E	Stay Arm Indication to Output -For monitoring purposes a Stay Arm indication can be assigned to an Output. Each Area can have a separate indication assigned to a different output if required	Output 3 only
P79E	Disarm Indication to Output -For monitoring purposes a Disarm indication can be assigned to an Output. Each Area can have a separate disarm indication assigned to a different output if required	Output 3 only
P80E	Armed Exit Delay Beeps to Output -When an Area is Armed it is useful to have the exit delay beeps occurring at the keypad to warn the User to exit the premises without delay. If the option is on at this address, that keypad will beep out the exit delay. The exit beeps occur at one second intervals until the last 5 seconds at which time they change to 1/2 second intervals to act as a warning that the delay is about to expire	Disable
P81E	Stay Exit Delay Beeps to Output -When an Area is Armed in Stay Mode it is useful to have the exit delay beeps occurring at	Disable

	the keypad to warn the User to exit the premises without delay. If the option is on at this address, that keypad will beep out the exit delay. This option may be turned off for Stay Mode to make the keypad silent when arming at night time. The exit beeps occur at one second intervals until the last 5 seconds at which time they change to 1/2 second intervals to act as a warning that the delay is about to expire. When arming Stay Mode the exit and entry delays can be cancelled by pressing the ENTER button following arming of Stay Mode. The next time Stay Mode is armed, if the ENTER button is not pressed, all programmed exit and entry delays will apply	
P82E	Pendant/Tag Arm Beep to Output -When Arming the alarm using a Radio Key or Access Tag it is necessary to have some form of Arm indication. This can be done by pulsing an Output once when the area is armed (one chirp).	Output 3 only
P83E	Pendant Stay Arm Beep to Output -When Arming Stay Mode using a Radio Key it is necessary to have some form of Arm indication. This can be done by pulsing an Output once when the area is armed (one chirp).	Output 3 only
P84E	Pendant/Tag Disarm Beep to Output -When Disarming the alarm using a Radio Key or Access Tag it is necessary to have some form of Disarm indication. This can be done by pulsing an Output twice when the area is disarmed (two chirps).	Output 3 only
P85E	Pendant Stay Disarm Beep to Output -When Disarming Stay Mode using a Radio Key it is necessary to have some form of Disarm indication. This can be done by pulsing an Output twice when the Stay Mode is disarmed (two chirps).	Output 3 only
P86E	Arm Pulse to Output - Double pulse will be applied to selected output (e.g. siren) indicating arming	Disable
P87E	Stay Arm Pulse to Output - Double pulse will be applied to selected output (e.g. siren) indicating arming	Disable
P88E	Disarm Pulse to Output -A single pulse will be applied to output (e.g. siren) indicating disarming	Disable
P89E	Stay Disarm Pulse to Output -A single pulse will be applied to selected output (e.g. siren) indicating disarming selected	Disable
P90E	Pulse output every 5 sec when disarmed -This option will cause output to pulse every 5 seconds when the area is disarmed. The pulse time is linked to the Output Pulse Time.	Disable

3.8: Areas/Beeps to Keypad

Address	Description	Default
P91E	Armed Exit Delay Beeps to Keypad - When an Area is Armed it is useful to have the exit delay beeps occurring at the keypad to warn the User to exit the premises without delay. If the option is on at this address, that keypad will beep out the exit delay. The exit beeps occur at one second intervals until the last 5 seconds at which time they change to 1/2 second intervals to act as a warning that the delay is about to expire	Enable
P92E	Stay Armed Exit Delay Beeps to Keypad - When an Area is Armed in Stay Mode it is useful to have the exit delay beeps occurring at the keypad to warn the User to exit the premises without delay. If the option is on at this address, that keypad	Disable

Address	Description	Default
	will beep out the exit delay. This option may be turned off for Stay Mode to make the keypad silent when arming at night time. The exit beeps occur at one second intervals until the last 5 seconds at which time they change to 1/2 second intervals to act as a warning that the delay is about to expire. When arming Stay Mode the exit and entry delays can be cancelled by pressing the ENTER button following arming of Stay Mode. The next time Stay Mode is armed, if the ENTER button is not pressed, all programmed exit and entry delays will apply	

3.9: Areas/Area Names

Address	Description	Default
P93E	Area Name - Enter Area name, up to 16 characters	" Area #"

4: Keypads

4.0: Keypads/Settings

Address	Description	Default
P94E	Beeps Enabled - Enable beeps on keypad	Enable
P95E	No keypad indications when armed -This option allows the screen information on a keypad to be turned off when the panel is in the Armed or Stay Armed state. The screen returns to the normal state on disarming of the system.	Disable
P96E	Turn Off backlight when not touched -The screen's backlight and LEDs will turn off within 90 seconds at disarm state or 10 seconds at arm state if the keypad was not touched.	Disable

4.1: Keypads/Area Assignment

Address	Description	Default
P97E	Keypad Assigned To Area -This option assigns keypad to area. For example, if keypad is assigned to only area 1 it can arm or disarm that area only.	All Keypads assigned to area 1,2,3,4

4.2: Keypads/User Assignment

Address	Description	Default
P1018E	User can operate at keypad -Any user can be assigned to only operate at certain Keypads. This option controls whether a code or access tag User can Arm/Disarm from certain keypads. This option does not restrict users from operating outputs from a particular keypad (this is done at locations P82E & P83E)	Enable

4.3: Keypads/Output Assignment

Address	Description	Default
P98E	Keypad is linked to Output -A Keypad can be assigned to an	Enable

Address	Description	Default
	Output or multiple Outputs. If a Keypad is not assigned to an Output a User cannot turn that Output On or Off from the Keypad. This feature is useful when using the access control features of the panel, eg a User may be allowed to operate more than one Output with their code but they will be limited to just the Output assigned to the Keypad they are using	

4.4: Keypads/Alarm to Outputs

Address	Description	Default
P59E	Keypad Panic Alarm to Output - A Keypad Panic Alarm (pressing C & D buttons together) can be assigned to an Output or multiple Outputs. This can be used to operate an audible or visual alarm connected to the Output	Enable for outputs 1,2,4,5
P99E	Keypad Fire Alarm to Output - A Keypad generated Fire Alarm (pressing the A & B) can be assigned to an Output or multiple Outputs. This can be used to operate an audible or visual alarm connected to the Output	Enable for outputs 1,2,4,5
P100E	Keypad Medical Alarm to Output - A Keypad generated Medical Alarm (pressing the B & C) can be assigned to an Output or multiple Outputs. This can be used to operate an audible or visual alarm connected to the Output	Enable for outputs 1,2,4,5
P101E	Keypad Tamper Alarm to Output - If the keypad has a Tamper Switch fitted and this switch is activated, the Tamper Alarm can be assigned to an Output or multiple Outputs. This can be used to operate an audible or visual alarm connected to the Output	Enable for output 2 Note: not relevant to keypad 1 which is control panel keypad
P102E	Wrong Code Alarm to Output - If someone is attempting disarm the alarm by trying various code combinations and they enter in 5 wrong codes the panel will go into a 'Wrong Code' tamper alarm. The Alarm can be assigned to an Output or multiple Outputs. This can be used to operate an audible or visual alarm connected to the Output. A correct code entry will reset the tamper alarm	Disable

4.5: Keypads/Beeps to Keypads

Address	Description	Default
P103E	Mains Fail Beeps Keypad Buzzer - If this option is on a Mains Failure will cause the keypad buzzer to sound continuously. The continuous beep will automatically clear when the Mains returns to normal or it can be silenced by pressing the ENTER button on the keypad	Disable
P104E	Fuse Failure Beeps Keypad Buzzer - If this option is on a Fuse Failure (12v DC output short) will cause the keypad buzzer to sound continuously. The continuous beep will automatically clear when the short is removed and the fuse returns to normal or it can be silenced by pressing the ENTER button on the keypad	Disable
P105E	Battery Low Beeps Keypad Buzzer - If this option is on a Panel Battery Low will cause the keypad buzzer to sound	Disable

	continuously. The continuous beep will automatically clear when the battery returns to normal or it can be silenced by pressing the ENTER button on the keypad	
P106E	Communication Failure Beeps Keypad Buzzer - If this option is on a Telephone Line Failure will cause the keypad buzzer to sound continuously. The continuous beep will automatically clear when the Telephone Line returns to normal or it can be silenced by pressing the ENTER button on the keypad	Disable
P107E	System Tamper Alarm Beeps Keypad Buzzer - If this option is on a Panel Tamper Alarm will cause the keypad buzzer to sound continuously. The Alarm must then be cleared by entering in a valid code at the keypad	Enable For all Keypads
P108E	Panic Alarm Beeps Keypad Buzzer - This function allows the user to choose which of the keypads will sound their buzzers when Panic Alarm is activated.	Enable For all Keypads
P109E	Fire Alarm Beeps Keypad Buzzer - This function allows the user to choose which of the keypads will sound their buzzers when Fire Alarm is activated.	Enable For all Keypads
P110E	Medical Alarm Beeps Keypad Buzzer - This function allows the user to choose which of the keypads will sound their buzzers when Medical Alarm is activated.	Enable For all Keypads
P111E	Wrong Code Beeps Keypad Buzzer - If someone enters in an incorrect code more than 4 times, the alarm can be silent or it can operate the buzzer in the keypad.	Enable For all Keypads
P112E	Keypad Tamper Beeps Keypad Buzzer - If a keypad tamper switch alarm is generated, the alarm can be silent or it can operate the buzzer in the keypad.	Enable For all Keypads
P391E	Output Tamper Beeps Keypad Buzzer - This function allows the user to choose which of the keypads will sound their buzzers when an output sends Tamper Alarm signal.	Enable For all Keypads

4.6: Keypads/Keypad Pairing

Address	Description	Default
P379E	Pairing Keypad - Every keypad must be paired into the panel before it can be used.	
P381E	Remove Keypad - Removing previously paired keypad from the system.	

4.7: Keypads/Control Menu

Address	Description	Default
P113E	Control Menu - Arrange Control Menu commands. By default control menu has the following structure: Memory -Arm area 1- Stay arm area 1- Bypass - Bypass group - Local configuration - Quick Programming - Dial phone number- voice mail-Active time zones.	(see description)

4.8: Keypads/Function Buttons

Address	Description	Default
P114E	Function Buttons - Assign command to the 4 function buttons. By default the functions assigned are: 'A' button - Arm, 'B' button - Stay Arm, 'C' button - Bypass, 'D' button-Memory.	(see Description)

5: [Keyswitch](#)

5.0: Keyswitch/Settings

Address	Description	Default
P115E	Keyswitch assigned to Zone 32 - this option enables zone 32 as a keyswitch function	Enable
P116E	Keyswitch can Arm -This option enables Arming of the assigned Area via the Keyswitch	Enable
P117E	Keyswitch can Disarm -This option enables Disarming of the assigned Area via the Key-switch	Enable

5.1: Keyswitch /Options

Address	Description	Default
P118E	Keyswitch is Normally Open - The key-switch can be a NO (Normally Open) or a NC (Normally Closed) key-switch.	Disable
P119E	Keyswitch is Momentary - The operation of the key-switch can be momentary or latching. If this option is on, the key-switch operation is assumed to be momentary. This means that each time the key-switch is operated then released the area will toggle its current state (I.e. if armed it will become disarmed or vice versa). If this option is turned off it is assumed that the key-switch is a latching type. This means that when the key-switch is operated and the key removed the contacts remain in the same state. When a latching key-switch is used, turning on the switch will arm the area and turning it off will disarm the area. If system restarts after loss of power, the key-switch automatically arms/disarms the area in which zone 32 is assigned when it's set on momentary mode	Enable

6: [Clock and Timers](#)

6.0: Clock and Timers/System Date & Time

Address	Description	Default
P120E	System Date - The Real Time Clock controls the Time-zones, the timing of automatic test connections and is used to Time and Date stamp the events in the Event Buffer. Ensure this is set correctly at the time of installation so that the functions affected by it will work properly. The clock is programmed in 24 hour format (eg 00:00-23:59)	Disable
P121E	Daylight Saving -If you are in Daylight Saving Time when the alarm system is installed you MUST turn this option on so that the panel knows that Daylight Saving Time is currently active. Failure to do this will not allow the clock to automatically adjust	Disable

Address	Description	Default
	to the correct time when Daylight Saving Time Ends	
P122E	GMT- (TBD)	0

6.1: Clock and Timers/Date Format

Address	Description	Default
P123E	European date format- European date format	Enable
P124E	American date format- American date format	Disable

6.2: Clock and Timers/Timers

Address	Description	Default
P125E	Radio Zone Supervised Time- If a radio detector is capable of sending regular supervisory signals to the panel and the zone type is set for 'Supervised Signal Active', this timer sets how long a period has to elapse with no received transmissions before a supervisory failure alarm is generated. The time range is 1-255 minutes.	60m
P126E	Two Trigger Time- If a zone is set to two trigger, the zone has to cause an alarm twice within the two trigger time period to cause an alarm. If multiple zones are set to two trigger, an alarm will be generated if two zones trigger once each within the two trigger time period. If a two trigger zone goes into alarm but remains in alarm for longer than the two trigger time period (i.e. detector failure or cable cut) an alarm will be generated. The time range is 5-255 seconds.	20s

6.3: Clock and Timers/Delays

Address	Description	Default
P127E	Alarm Reporting Delay (seconds) -If this address is set to 0, there will be no report delay. If it is set to any value other than 0 then a delay equal to the programmed value will stop the panel from reporting an alarm until this delay time expires. While the timer is active certain outputs can be disabled at location [P43]. Once the timer has expired it will not start again, the panel must be disarmed then armed to reset the timer. The value is in seconds, maximal limit is 255 seconds.	Disable
P128E	Mains Fail Reporting Delay (seconds) -If a Mains Failure occurs this timer delays the reporting of Mains Failure to a Monitoring Station. If the mains power returns before the timer expires, then no report is sent. If Mains Failure is assigned to an output, this delay must expire before the output will turn on. Upper limit is 10800 seconds (3 hours)	300s
P240E	Communication Fail Reporting Delay (seconds)- If a Communication Fail occurs this timer delays the reporting of Communication Fail to a Monitoring Station. If specified communication path returns before the timer expires, then no report is sent. If Communication Fail is assigned to an output, this delay must expire before the output will turn on. The value in seconds, maximal limit is 3 hours (10800 seconds).	Disable

7: [Zones](#)

7.0: Zones/Status

Address	Description	Default
P129E	Zone is active - Zone will be monitored by the panel.	Disable
P130E	Stay mode zone -Zone will cause alarm if triggered when Stay Mode is armed. This feature is normally used for arming just part of the alarm at night time.	Enable
P131E	Two trigger zone - If this option is on the zone will have to trigger twice within the two trigger time [P126] before it will cause an alarm. If the zone does not trigger a second time before the two trigger time expires, the count is reset and it will take another two triggers to cause an alarm on this zone. If more than one zone is set-up as a two trigger zone, then a single trigger from two separate zones within the two trigger time can also cause an alarm. If the zone becomes faulty and still open once triggered at end of two trigger time period it will also cause an alarm.	Disable
P132E	Exit delay zone - Zone should be closed for ready to arm. It will not cause an instant alarm if triggered during the exit delay time.	Enable
P133E	Can Arm if Zone is not Ready - Zone can remain open during arming and will cause alarm in case it will remain open after the exit delay expired.	Zone 1 & 2 only
P134E	Handover zone - A Handover Zone is one that its entry delay will apply provided a Non-Handover entry zone is triggered first. If no other entry delay zones are triggered before the handover zone the entry delay on that zone does not apply and the alarm will become instant (no entry delay)	Zone 2 only
P135E	Manually bypassed zone - Zone can be manually bypassed at the keypad while in the disarmed state. Once the area with the bypassed zone has been armed and then disarmed, the manual bypass is removed and the zone must be manually bypassed again before arming if required.	Enable
P136E	Auto bypassed zone - Zone will be auto-bypassed if unsealed at the expiry of the exit delay. If a zone is unsealed at the time of arming and remains unsealed when the exit delay expires and this option is on for that zone it will be automatically bypassed by the panel. If the zone seals after that time it will be re-instated automatically and can then cause an alarm. On disarming of the alarm any auto-Bypasses are removed	Disable

7.1: Zones/Area Assignment

Address	Description	Default
P137E	Zone assigned to area - This option assigns the Zone to Area. If a Zone is assigned only to one area it will activate if specified area is armed. If zone assigned to more than one area it will activate only when all assigned areas are armed. By default all zones assigned to Area 1.	(see Description)

7.2: Zones/Working Mode

Address	Description	Default
P138E	Zone is normal - Zone without any special behavior.	Enable
P139E	Zone is 24 hour zone- If this option is on the zone will be constantly monitored regardless of the arm/disarm state of the panel. If the 24 Hour zone also has an entry delay programmed [P174], this delay will apply. If the 24 Hour zone activates but then resets before the entry delay expires no alarm will be generated. Once the alarm has been generated it must be cleared by entry of a valid User code	Disable
P140E	Zone is 24 hour auto-reset zone- If this option is on the zone will be constantly monitored regardless of the arm/disarm state of the panel. Once an alarm has been generated with a 24 Hour Auto-reset zone, the alarm will be reset automatically once the zone is closed. If the 24 Hour zone also has an entry delay programmed [P174], this delay will apply. If the 24 Hour zone activates but then resets before the entry delay expires no alarm will be generated. This feature can be useful for monitoring plant type alarms such as freezer alarms.	Disable
P141E	Zone is 24 hour fire zone- If this option is on the zone will be constantly monitored regardless of the arm/disarm state of the panel. If the 24 Hour Fire zone also has an entry delay programmed [P174], this delay will apply. If the 24 Hour Fire zone activates but then resets before the entry delay expires no alarm will be generated. Once the alarm has been generated it must be cleared by entry of a valid User code.	Disable
P142E	Chime zone- If this option is on, the zone will operate Chime mode when disarmed. When the alarm is armed the Chime Mode is disabled for this zone. A Chime zone can sound the keypad buzzer or operate an output to indicate that the zone is unsealed. It is normally used to monitor areas during the daytime	Disable
P143E	Permanent chime zone- If this option is on, the zone will operate Chime mode when armed or disarmed. When the alarm is armed the zone will continue to only be a Chime Mode Zone and will not cause a burglar alarm. A Chime zone can sound the keypad buzzer or operate an output to indicate that the zone is unsealed.	Disable

7.3: Zones/Options

Address	Description	Default
P144E	Zone will not report 24 hour alarm - If this option is turned on and the zone is set as a 24 Hour type, when an alarm is generated, the alarm will not be transmitted to the monitoring station via the dialler	Disable
P145E	Zone in Bypass Group- Zone belongs to bypass group. Zones that have been assigned to the group could be bypassed simultaneously.	Disable
P146E	Zone Sends Reports- Zone that has this option marked can send zone alarm/stay alarm report through all enabled communication channels,	Enable

Address	Description	Default
	unless defined differently in report channels (See P147E and P234E).	
P147E	Zone is on Soak Test- If a zone is suspected of being faulty and is causing false alarms, you can turn it into a Soak Test Zone and it will still be monitored for alarms (NO beeps or buzzer) when armed but it won't cause the sirens to sound or report via any protocol. The Soak Test zone will still be logged in the event memory however so it is possible to check the activity of the zone, via the memory. and after a suitable period of no alarms it can be re-instated as part of the alarm by removing the Soak Test option	Disable
P148E	Exit Terminator Zone- If this option is on, when the zone unseals during the exit delay (P74) time and then seals again, the panel will cancel any remaining exit delay time and arm in 3 seconds from the time the zone was sealed.	Disable

7.4: Zones/Zones Response Time

Address	Description	Default
P149E	High vibration mode (50ms)	Disable
P150E	Middle vibration mode (100ms)	Disable
P151E	Low vibration mode (150ms)	Disable
P152E	Response of 200 ms	Enable
P153E	Response of 250 ms	Disable
P154E	Response of 300 ms	Disable
P155E	Response of 350 ms	Disable

7.5: Zones/Alarms to Output

Address	Description	Default
P156E	Zone alarm assigned to output - If an Area is Armed and a zone assigned to that Area activates, the zone can trigger selected Outputs for local alarm signaling. This location assigns Zones to Outputs for alarms that occur when in the Full Armed State	All Zones Assigned to outputs 1,2,3,4
P157E	Zone stay alarm assigned to output- If an Area has Stay Mode Armed and a zone assigned to that Area activates, the zone can trigger selected Outputs for local alarm signaling. This location assigns Zones to Outputs for alarms that occur when Stay Mode is Armed	All Zones Assigned to outputs 1,2,3,4
P158E	Zone 24 hour alarm assigned to output- If zone is programmed as one of 24 Hour type zone [P139][P140][P141] and if it is open then the selected output(s) is activated for local alarm signalling. In case of standard 24 hour zone [P139] the output will be active for the full reset time. In case of 24 hour auto-reset zone [P140] the output is deactivated when the reset time expires or if zone is closed. If zone is a 24 hour fire zone [P141] then the output will pulse at a rate equals to the pulse time for that output.	All Zones Assigned to outputs 1,2,3,4

Address	Description	Default
P159E	Zone tamper assigned to output- Zone tamper can trigger selected output(s) for local alarm signaling.	All Zones Assigned to outputs 1,2,3,4
P160E	Chime zone alarm assigned to output- If a zone is programmed as a Chime zone [P142] and it activates, the zone can trigger selected Outputs for local alarm signaling. The output will operate for the Chime to Output time at location [P63]. The zone must clear before the output can be activated again	Disable
P161E	Armed zone entry delay assigned to output- If the alarm is Armed and a delay zone triggers the entry delay it can also turn an Output on to warn that the entry delay is counting down and the alarm should be turned off	Disable
P162E	Stay mode entry delay assigned to output- If Stay Mode is Armed and a delay zone triggers the entry delay it can also turn an Output on to warn that the entry delay is counting down and the alarm should be turned off	Disable
P163E	Zone near alarm assigned to output - If zones are programmed for near and verified alarms [P73], it is also possible to get an indication of a near alarm from any of the 16 outputs using this program location. A near alarm is the first alarm during an armed period	All Zones Assigned to outputs 1&2
P164E	Zone verified alarm assigned to output- If zones are programmed for near and verified alarms [P73], it is also possible to get an indication of a verified alarm from any of the 16 outputs using this program location. A verified alarm is the second alarm from a different zone to the one that caused the near alarm and must happen within 45 minutes of the near alarm	All Zones Assigned to outputs 1&2

7.6: Zones/Beeps to Keypad

Address	Description	Default
P165E	Armed Zone Alarm Beeps to Keypad - If an Area is Armed and a zone assigned to that Area activates, the zone can sound the buzzer at selected keypads for local alarm signaling. This location assigns zone alarm beep to a keypad for alarms that occur when in the Full Armed State.	Enable
P166E	Stay Mode Zone Alarm Beeps Keypad - If an Area is Stay Mode Armed and a zone assigned to that Area activates, the zone can sound the buzzer at selected keypads for local alarm signaling. This location assigns zone alarm beep to a keypad for alarms that occur when in Stay Mode is Armed	Enable
P167E	Zone 24 hour alarm beeps to keypad - If a zone is programmed as a 24 Hour type and it activates, the zone can sound the buzzer at selected keypads for local alarm signaling. If the zone is a standard 24 hour type [P139] or Fire type [P141] the keypad buzzer will sound until reset by a User but if it is an Auto-reset type [P140] the keypad buzzer will reset when the input clears	Enable
P168E	Chime Zone Alarm Beeps Keypad - If a zone is programmed as a Chime zone and it activates, the zone can sound the	Enable

Address	Description	Default
	buzzer at selected keypads for local alarm signaling. The duration of the Chime beep is programmed at location P94E. The Chime function can also be locally disabled at each keypad individually if not required.	
P169E	Zone Tamper Alarm Beeps Keypad - Zone tamper can beep the keypad buzzer at individual keypads	Enable
P170E	Radio Supervise Alarm Beeps Keypad - If a zone is programmed as a radio zone and that type is actively monitoring the supervision signal [P125], a supervise signal failure from the detector [P181] alarm can sound the buzzer at selected Keypads for local alarm signaling.	Enable
P171E	Zone Sensor-watch Alarm Beeps Keypad - If the zone is programmed for inactivity monitoring and it is not operated within the time set at [P176] a 'Sensor-watch' alarm will be generated. A 'Sensor-watch' failure from the detector can sound the buzzer at selected Keypads for local alarm signaling	Enable
P172E	Armed zone entry delay beeps to keypad - If the alarm is Armed and a delay zone triggers the entry delay it can also beep the keypad buzzer to warn that the entry delay is counting down and the alarm should be turned off	Enable
P173E	Stay mode entry delay beeps to keypad - If Stay Mode is Armed and a Stay Mode delay zone triggers the entry delay it can also beep the keypad buzzer to warn that the entry delay is counting down and the alarm should be turned off	Disable

7.7: Zones/Delays and Timers

Address	Description	Default
P174E	Armed zone entry delay time, (sec) - Each Zone has its own Entry Delay time when in the Full Armed State. The delay can be programmed from 0-9999 seconds in one second increments. If the entry delay is set to 0 the zone will be an instant zone	20 sec for zones 1 & 2
P175E	Stay mode entry delay time, (sec) - Each Zone has its own Entry Delay time when in Stay Mode. The delay can be programmed from 0-9999 seconds in one second increments. If the entry delay is set to 0 the zone will be an instant zone	20 sec for zones 1 & 2
P176E	Sensor watch-time, (min) - If value of this option is greater than zero then zone will be checked to see that it operates during the disarmed state. If it is not operated within the specified time a 'Sensor-watch' alarm will be generated. This feature is designed to detect a faulty zone that is not operating normally or one that has had it's detection area blocked. The timer is stopped when the area assigned to the zone is armed and resumes with the specified value when disarmed again. The timer is reset back to the original value every time the zone operates while disarmed. Range of values from 0 to 9999 minutes.	0

7.8: Zones/Radio Zones

Address	Description	Default
P177E	Learn Radio Zone - Radio detector must be enrolled into the panel before it can be used. pressing of Detector's tamper switch will be used for learning operation	Disable
P178E	Find Radio Zone - Finding location (Zone #) of previously enrolled detector.	Disable
P179E	Delete Radio Zone - Removing radio zone from the system.	Disable
P180E	Radio Zone Reset config – This function resets to default parameters values which were defined in (P181E)of a radio zone	Disable
P181E	Radio Zone Config – This function set remotely the radio zone parameters such as led on/off, pulse detection, Pet immunity , Gain level, etc.	Disable NOTE: refer to " Setting of detector parameters " page 18 in this manual

7.9: Zones/Re-trigger

Address	Description	Default
P182E	Zone re-trigger count - Each Zone has its own alarm re-trigger count. A value of 0 programmed at this location results in unlimited alarms for that zone during an armed period but a count of 1-15 will shut down the zone once the programmed count has been reached. Disarming the alarm will reset this count. In case the zone is assigned to more than one area, this counter should be multiplied by number of areas (e.g. if zone 1 belongs to A1 & A2, to achieve re-trigger count = 3, you will need to enter re-trigger count = 6, because alarm in each area will increment the counter and common number of re-trigger counts will multiply).	0

7.10: Zones/Zone Names

Address	Description	Default
P183E	Zone Name - Set zone name, up to 16 characters	" Zone #"

8: [Time Zones](#)

8.0: Time Zones/Settings

Address	Description	Default
P186E	Time Zone Start Time - The Time-zone start time is when the time-zone begins. The time using for arm of area(s) ([P191]), turn output(s) to ON state ([P192]) and activate rights of specified user(s) ([P19]). There are 8 time-zones that can be programmed.	Disable
P187E	Time Zone End Time - The Time-zone end time is when the time-zone finishes. The time using for disarm of area(s) ([P191]), turns output(s) to OFF state ([P192]) and deactivate	Disable

Address	Description	Default
	rights of specified user(s) ([P19]). There are 8 time-zones that can be programmed.	
P188E	Time Zone Day- The Time-zone days are the days of week that the time-zone will be active. You can select any combination of the days from Sunday till Saturday. There are 8 time-zones that can be programmed.	Disable
P189E	Time Zone Password- When this option is not empty then time-zone is inactive until user enters valid password. After that time-zone behaves like an ordinary time-zone. By entering valid password once again user will deactivate time-zone. When time-zone start time expires then area(s) assigned to time-zone will arm after a 2 sec delay.	Disable
P190E	Holidays- It is possible to pre-program up to 8 holidays. Holidays can override the time-zone function on the programmed day. For example, if an output was automatically controlled by a time- zone, the pre-programmed holidays can stop the output from turning on or off on a holiday. A holiday consists of a single day programmed by date. The holiday begins at the start of the day (00:00:00) and finishes immediately before midnight (23:59:59) on the programmed date. Holidays can be programmed in any order (although for simplicity it is recommended that they are programmed in chronological order) and the panel automatically removes them once the day ends. If you wish to remove a programmed holiday you should to clear the date field.	Disable

8.1: Time Zones/Area Assignment

Address	Description	Default
P191E	Time Zone Assigned to Area - If area assigned to time-zone if will automatically armed when time-zone starts and disarmed when it finishes. You can assign more than one time-zone to each area. If assigning multiple time-zones you should insure that they do not overlap as this could cause confusion.	All time zones are assigned to Area1 only
P53E	Time Zone Stay Armed Area - The parameter is used for the separation time zone possibility to made ARM and STAY ARM operations. If the parameter marked when time zone will start, the corresponded area will STAY armed. Otherwise, when time zone will start the area will ARMED.	Disable

8.2: Time Zones/Output Assignment

Address	Description	Default
P192E	Time Zone Assigned to Output - If a time-zone is assigned to an output it will turn the output on when the time-zone starts and turn the output off when it finishes.	Disable

8.3: Time Zones/User Assignment

Address	Description	Default
---------	-------------	---------

Address	Description	Default
P1019E	User Controlled by Time Zone - When the user is controlled by time zone, its keypad code, access tag and pendant deactivated all the time, when the time zone is not started or finished. Only when the time zone is started, the user can perform actions in the system in accordance with its rights as defined by configuration.	Disable

9: [Report Channels](#)

9.0: Report Channels/Channel Type

Address	Description	Default
P193E	<p>TCP_IP - Set channel type as TCP/IP. Need to set PSTN enabled to use this type of channel. Default assignment: channels 1,2 - ContactID PSTN, channels 3,4, - voice message PSTN, channel 5, 6 - SMS, channel 7 - TCP/IP and channel 8 - GPRS.</p> <p>Note 1: 1.Any transition between TCP/IP to GPRS mode and vice versa will be rejected, unless you deactivate the conflicting channel/s first (P201) 2. If you set TCP/IP as a backup channel, set it so that its operation won't coincide with a GPRS channel's operation</p> <p>Note 2: by default, channel 7 set as active TCP/IP for cloud connection and channel 8 as GPRS used for backup of channel 7.</p>	(see Description)
P194E	<p>GPRS - Set channel type as GPRS. Need to set PSTN enabled to use this type of channel. Default assignment: channels 1,2 - ContactID PSTN, channels 3,4, - voice message PSTN, channel 5, 6 - SMS, channel 7 - TCP/IP and channel 8 - GPRS.</p> <p>Note: 1.Any transition between TCP/IP to GPRS mode and vice versa will be rejected, unless you deactivate the conflicting channel/s first (P201) 2. If you set GPRS as a backup channel, set it so that its operation won't coincide with a TCP/IP channel operation</p>	GPRS works if CID GSM is disable
P195E	<p>CID PSTN - Set channel type as CID PSTN. Need to set PSTN enabled to use this type of channel. Default assignment: channels 1,2 - ContactID PSTN, channels 3,4, - voice message PSTN, channel 5, 6 - SMS, channel 7 - TCP/IP and channel 8 - GPRS.</p>	(see Description)
P196E	<p>CID GSM - Set channel type as CID GSM. Need to set PSTN enabled to use this type of channel. Default assignment: channels 1,2 - ContactID PSTN, channels 3,4, - voice message PSTN, channel 5, 6 - SMS, channel 7 - TCP/IP and channel 8 - GPRS.</p>	CID GSM works if GPRS is disable GPRS can't be backup for GSM (CID or voice)
P197E	<p>SIA PSTN - Set channel type as SIA PSTN. Need to set PSTN enabled to use this type of channel. Default assignment: channels 1,2 - ContactID PSTN, channels 3,4, - voice message PSTN, channel 5, 6 - SMS, channel 7 - TCP/IP and channel 8 - GPRS.</p>	(see Description)

Address	Description	Default
P198E	SMS - Set channel type as SMS. Need to set PSTN enabled to use this type of channel. Default assignment: channels 1,2 - ContactID PSTN, channels 3,4, - voice message PSTN, channel 5, 6 - SMS, channel 7 – TCP/IP and channel 8 - GPRS.	SMS works if CID GSM or GSM-IP is enable
P199E	Voice Message PSTN Set channel type as Voice Message PSTN. Need to set PSTN enabled to use this type of channel. Default assignment: channels 1,2 - ContactID PSTN, channels 3,4, - voice message PSTN, channel 5, 6 - SMS, channel 7 – TCP/IP and channel 8 - GPRS.	(see Description)
P200E	Voice Message GSM - Set channel type as Voice Message GSM. Need to set PSTN enabled to use this type of channel. Default assignment: channels 1,2 - ContactID PSTN, channels 3,4, - voice message PSTN, channel 5, 6 - SMS, channel 7 – TCP/IP and channel 8 - GPRS..	(see Description)

9.1: Report Channels/Settings

Address	Description	Default
P201E	Active Channel – This option is used to activate/deactivate a channel.	Enable
P202E	Phone Number or Server Address - Can be up to 8 phone numbers (for channels defines as PSTN/GSM/Voice/SMS) or 8 server addresses (for channel defined as TCP-IP/GPRS) or DNS Name. The length is up to 50 characters long (digits only for phone numbers and characters/digits for server address).	Ch-7 and Ch-8 set to panel.crowcloud.com Ch-8 is set to backup Ch-7
P203E	Channel Backup - This channel will be selected if main channel has failed to open connection or deliver a message. Note: A Main channel can directly have only one backup channel. You can indirectly set more than one backup channel by creating a chain of backup channels (For example, Active channel 1 has channel 2 set as backup, channel 2 has channel 3 as backup and so on)	Disable
P204E	Stay On-line after Alarm report for two way voice - if this option is turned ON and a full duplex two way voice board is fitted, the panel will send a command to the monitoring company in CID or SIA formats to tell the receiver to stay on-line so the operator can listen or talk to the site (full duplex two way voice).	Enable
P205E	Failed channel restore time - If either channel has failed to deliver messages it will be temporarily disabled for a period of time defined by this parameter. During this time the corresponding backup channel will be used.	3m
P375E	Use SMS channel for sending Contact ID report- if this option is turned ON, the corresponding report channel, defined as SMS type, will send Contact ID report instead of regular text string.	Disable

9.2: Report Channels/Area Account Number Assignment

Address	Description	Default
---------	-------------	---------

Address	Description	Default
P206E	<p>Account Number - When reporting to a monitoring Station there must be a unique account code programmed to identify the area\’s reported.</p> <p>Each area has an account code. The account code is up to 4 characters for all protocols, except SIA and Voice message\SMS (see notes below).</p> <p>Each character can be a number from 0-9 as well as the special characters B, C, D, E & F.</p> <p>Take note that the number must be different than zero (0000 or 000000).</p> <p>NOTE:</p> <ol style="list-style-type: none"> 1. SIA protocol- 6 characters 2. All other protocols – 4 characters 3. You can use the characters 0-9 B,C,D,E,F 4. You don't need an ACC number When channel is programmed as Voice message/SMS protocol 	<p>All Zeros</p> <p>A letter - not in use</p>

9.3: Report Channels/Reporting Options

Address	Description	Default
P207E	Report Mains Failure - If this option is on the panel will report a Mains fail after the report delay time [P128] has expired	Channels 3,4,- Off All others - On
P208E	Report System Battery Low -If this option is on the panel will report a Battery Low	Enable
P209E	Report Communication fail - If this option is on the panel will report a Communication fail.	Channels 3,4,- Off All others - On
P210E	Report System Tamper - If this option is on the panel will report a Tamper Alarm on the panel tamper input	Enable
P211E	Report Keypad Tamper - If this option is on the panel will report a Tamper Alarm from a keypad fitted with a tamper switch or a wrong code alarm from a keypad	Enable
P212E	Report Zone Tamper -- If this option is on the panel will report a Zone Tamper Alarm	Enable
P213E	Report Duress Alarm - If this option is on the panel will report a Duress Alarm [P311]	Enable
P214E	Report Panic Alarm - If this option is on the panel will report a Panic Alarm generated by keypad or RMT (pendant)	Enable
P215E	Report Manual Fire Alarm - If this option is on the panel will report a Keypad generated Fire Alarm	Enable
P216E	Report Manual Medical Alarm - If this option is on the panel will report a Keypad generated Medical Alarm	Enable
P217E	Report Zone Bypasses - If this option is on the panel will report a Manual or Auto Bypass of a zone	Channels 3,4,- Off All others - On
P218E	Report Arm-Disarm - If this option is on then all Arm/Disarm	Channels 3,4,- Off

Address	Description	Default
	signals will be reported to a Monitoring Station	All others - On
P219E	Report Stay Mode Arm-Disarm- If this option is on then all Stay Mode Arm/Disarm signals will be reported to a Monitoring Station	Channels 7,8,- on All others - off
P220E	Report Disarm only after an Activation- If this option is on, the panel will not normally send an Arm/Disarm signal to the monitoring company, however, if a zone alarm occurs then the panel will send a Disarm following the disarming of the panel to show it has been turned off by a valid user	Channels 7,8,- on All others - off
P221E	Report Stay Mode Disarm only after an Activation- If this option is on, the panel will not normally send a Stay Mode Arm/Disarm signal to the monitoring company, however, if a zone alarm occurs then the panel will send a Stay Mode Disarm following the disarming of the panel to show it has been turned off by a valid user	Channels 7,8,- on All others - off
P222E	Report Access to Program Mode- If this option is on the panel will report a Contact ID code to indicate that either User or Installer program Modes have been accessed	Channels 7,8,- on All others - off
P223E	Report Zone Restores- If this option is on the panel will report all zone restores. If this option is turned off the panel will only report the alarms	Channels 3,4,- Off All others - On
P224E	Report Delinquent- If the panel has been configured for Delinquency monitoring [P76] and an area has not been armed for the time set at [P76], a Delinquency Alarm will be sent to the Monitoring Station	Channels 3,4,- Off All others - On
P225E	Report Fuse Failure- The panel has two on-board thermal fuses designed to protect the 12v DC outputs from short circuits. If this option is on and either of these fuses are open, a report will be sent to the monitoring station if Contact ID is set as the reporting format	Channels 3,4,- Off All others - On
P226E	Report Radio Battery Low- If this option is on the panel will report a Battery Low from any radio zones that have the battery status monitored	Channels 3,4,- Off All others - On 3,4,5,7 - Off All others - On
P227E	Report Supervised Radio Alarm- If this option is on the panel will report a Supervised radio Alarm (see [P125])	Channels 3,4,- Off All others - On
P228E	Report Zone Sensor-watch Alarm- If this option is on the panel will report a Zone Inactivity (Sensor-watch) Alarm (see [P176])	Channels 3,4,- Off All others - On
P229E	Report Latchkey Disarm- When this option is turned on and the panel was armed in Latchkey Report Mode, at disarm by non-latchkey user the specified latchkey disarm report will be send via voice or SMS report channel to user, marked as latchkey mode user ([P8]).	Channels 1,2,- Off All others - On
P230E	Report communication (RF) Interference Detected- If the radio receiver detects RF Interference (Jamming) of the radio frequency, the panel can report this event to the monitoring station if this option is turned on	Channels 3,4,- Off All others - On
P231E	Report Output Fail- If this option is on and a fault is detected on the output, a report will be sent to the monitoring station if	Channels 7,8,- on

Address	Description	Default
	Contact ID is set as the reporting format	All others - off
P232E	Report Tests- If this option is turned on panel can send automatic test connections, but if test connections are not required they can be disabled by turning this option off.	Channels 7,8,- on All others - off
P234E	Report Stay Mode Zone Alarms- If this option is on, the panel will report zone alarms in Stay Mode	Enable
P235E	Report output changed- The changing output state will be reported via SMS or Voice reporting to the user	Channels 7,8,- on All others - off
P373E	Report Peripheral Tamper- If this option is on the panel will report a Tamper Alarm from a peripheral module (extender module or radio output) fitted with a tamper switch from a peripheral module	Channels 7,8,- on All others - off
P353E	Report Zone Confirmed Alarm - If this option is on the panel will report a Zone Confirmed (Near and Verified) Alarms (see [P73])	Channels 7,8,- on All others - off

10: [Communications](#)

10.0: Communications/Remote Access

Address	Description	Default
P236E	Remote Access Password – up to 8 character password for remote pc application access. (randomly number is provided during production)	Enable
P237E	Remote Access only if disarmed- if this option is on the Remote access option is allowed only in disarmed state.	Disable
P388E	Enable Direct Remote Access - This option uses for remote user remote control of the system via string commands. Due to the fact that this option works on an open non-secure protocol its use is recommended only for testing or to use the control panel as part of another system (such as Home Automation system).	Enable
P233E	Remote Access Server - This parameter defines IP-address or DNS name of remote access server. The server using for remote access (WEB access for example), and control panel should to make registration on server to provide remote access.	panel.crowcloud.com
P246E	Remote Access Server Port - This parameter defines port on remote access server the control panel using for remote control.	Port - 4701
P316E	Server Registration Time - The time of periodical confirmation of registration on remote access server. Using for check validation of control panel address on server. If control panel use constant IP, the parameter can be set to 0.	1m
P317E	Remote Access From Server Only - If this flag is ON remote access can be accepted from Remote Access Server after successful registration only.	Disable

10.1: Communications/Phone Line communication Options

Address	Description	Default
P239E	Hold line still open for Voice – If this option is on , the dialer will keep the telephone line open after been answered to the voice message alarm PSTN call so that the person at the phone can then use their DTMF codes to enter an operational commands (see commands from P298 to P305).	Enable
P241E	Time to First test connection - Define the time of first automatic test connection. The following test connection time is defined by option [P242]	Disable
P242E	Test connection Time Period - Time period between successive automatic test connections	0
P243E	Phone Number for remote Control – Setting of up to 8 assigned phone numbers which are authorized for control the system remotely via DTMF control.	Disable
P244E	Phone use modem (data) connection - Option defines using the phone line in modem's data mode (as alternative to regular voice mode)	Disable

10.2: Communications/PSTN

Address	Description	Default
P245E	PSTN Enabled – If this option is on, the PSTN modems are enabled.	Enable
P247E	Auto-Answer Ring Count - If the PSTN is used for remote control, the number of rings before panel answers the call can be set at this parameter. Minimal value is 2 for using caller ID detection (see also P248E).	10
P248E	Answering System Defeat – The panel can automatically answer an in-coming call in two ways. The first is set auto-answer ring count to a convenient number (P247E) and let the phone ring until this number is reached at which time the panel will answer the call. The second method is to use Answering System Defeat which entails calling to the panel and letting to ring no less than two times, hanging up, and then ringing back within 45 seconds. The panel will now answer the call on the second ring.	Enable
P394E	Use Hash for confirmation - This parameter defines using hash button for confirmation of audio reporting is heard by user. If the parameter is set, user should press hash button to start hearing the voice report message. If the parameter not set, the voice report message will played till remote phone will close connection (hangs down), message will play several times without confirmation and in this case the backup for the PSTN Voice report channel cannot work, because system don't know about message was received by user.	Enable

10.3: Communications/GSM

Address	Description	Default
P249E	GSM IP Enabled – if this option is on , the GSM IP is Enabled	Disable
P250E	GSM CID Enabled - If this option is on, the GSM CID is Enabled.	Disable

Address	Description	Default
P251E	PIN Code – GSM pin code number according GSM network requirements, up to 8 digits length.	Disable
P252E	GSM User - GSM user according GSM network requirements.	Disable
P253E	GSM Password - GSM Password according GSM network requirements.	Disable
P254E	GSM APN - GSM access point name according to your cellular provider. Up to 32 characters	Internet
P380E	Unstructured supplementary service data- Unstructured Supplementary Service Data (USSD) is a protocol used by GSM cellular telephones to communicate with the service provider's computers. The parameter contains 3 decimal digit.	0

10.4: Communications/TCP-IP

Address	Description	Default
P255E	Ethernet Enabled - If this option is on, the Ethernet connection is Enabled.	Enable
P256E	DHCP Enabled - Dynamic Host Configuration Protocol (DHCP) is a network protocol that enables a server to automatically assign an IP address to a control panel from a defined range of numbers configured for a given network. If this option is on, the DHCP is Enabled. Note: If P256 is enabled, you won't be able to access P257-P260	Enable
P257E	Static IP - In the absence of DHCP, control panel may be manually configured with an IP address (P257), subnet mask (P258), gateway (P259), DNS server (P260). up to 16 characters	Disable
P258E	Subnet Mask - The network subnet mask for defined static IP address. up to 16 characters	Disable
P259E	Gateway - The network gateway address for defined static IP address. up to 16 characters	Disable
P260E	DNS Server - The network DNS server address for defined static IP address. up to 16 characters	Disable
P377E	TCP Remote Control Port - The TCP/IP port number used for remote control applications	3064
P378E	TCP Receiver Port - The TCP/IP port number used by report channel for connection to TCP receiver.	4700

10.5: Communications/Can - Bus

Address	Description	Default
P261E	CAN-bus Enabled – If this option is on, the CAN serial bus protocol is enabled to connect individual systems such as an extender zone/output cards or external keypads.	Disable

10.6: Communications/Contact ID Codes

Address	Description	Default
---------	-------------	---------

Address	Description	Default
P262E	Zone Alarm Contact ID Code - Set Contact ID code for zone alarm. Code value has to be from 1000 to 1999. when input is zero, system uses default code	0
P263E	Zone Near Alarm Contact ID Code - Set Contact ID code for zone near alarm. Code value has to be from 1000 to 1999. when input is zero, system uses default code	0
P264E	Zone Verified Alarm Contact ID Code - Set Contact ID code for zone verified alarm. Code value has to be from 1000 to 1999. when input is zero, system uses default code	0
P265E	Panic Alarm Contact ID Code - Set Contact ID code for panic alarm. Code value has to be from 1000 to 1999. when input is zero, system uses default code	0
P266E	Fire Alarm Contact ID Code - Set Contact ID code for fire alarm. Code value has to be from 1000 to 1999. when input is zero, system uses default code	0
P267E	Medical Alarm Contact ID Code - Set Contact ID code for medical alarm. Code value has to be from 1000 to 1999. when input is zero, system uses default code	0

10.7: Communications/SIA Codes

Address	Description	Default
P268E	Zone Alarm SIA Code - Set SIA code for zone alarm. Code value has to be two letters from A to Z. when input field is empty, system uses default code	
P269E	Panic Alarm SIA Code - Set SIA code for panic alarm. Code value has to be two letters from A to Z. when input field is empty, system uses default code	
P270E	Fire Alarm SIA Code - Set SIA code for fire alarm. Code value has to be two letters from A to Z. when input field is empty, system uses default code	
P271E	Medical Alarm SIA Code - Set SIA code for medical alarm. Code value has to be two letters from A to Z. when input field is empty, system uses default code	

10.8: Communications/Voice Message Numbers

Address	Description (Note: Recording time for each message is up to 5 seconds User can recorded custom voice message for below default messages)	Default
P272E	Zone Alarm Voice Message	Disable
P273E	Panic Alarm Voice Message	Disable
P274E	Fire Alarm Voice Message	Disable
P275E	Medical Alarm Voice Message	Disable
P276E	Mains Failure Voice Message	Disable

Address	Description (Note: Recording time for each message is up to 5 seconds User can recorded custom voice message for below default messages)	Default
P277E	Mains Restore Voice Message	Disable
P278E	Battery Low Voice Message	Disable
P279E	Zone Battery Low Voice Message	Disable
P280E	Tamper Alarm Voice Message	Disable
P281E	Zone Tamper Alarm Voice Message	Disable
P282E	Duress Alarm Voice Message	Disable
P283E	Manual Test Initiated Voice Message	Disable
P284E	Latchkey Disarm Voice Message	Disable
P285E	Output is On Voice Message	Disable
P286E	Output is Off Voice Message	Disable
P287E	Area is Armed Voice Message	Disable
P288E	Area is Stay Armed Voice Message	Disable
P289E	Area is Disarmed Voice Message	Disable
P290E	Welcome Prompt Voice Message	Disable
P291E	Enter Password Prompt Voice Message	Disable
P292E	Enter User Password Prompt Voice Message	Disable
P293E	Password Error Voice Message	Disable
P294E	Enter Command Voice Message	Disable
P295E	Command Error Voice Message	Disable
P296E	Command Confirmed Voice Message	Disable
P297E	Enter Password and press hash button Message	Disable

10.9: Communications/Control Code Number

Address	Description – Maximum 4 digits per code /	Default
P298E	Turn Output on Control Code – The control code value has 1-4 digits. This code cannot starts from 0, Used when accessing Serenity remotely.	Output 1 =101 : Output 16 - 116
P299E	Turn Output off Control Code - The control code value has 1-4 digits. This code cannot starts from 0, Used when accessing Serenity remotely.	Output 1 =201 : Output 16 - 216
P300E	Microphone Control Code - The control code value has 1-4 digits. This code cannot starts from 0, Used when accessing Serenity remotely.	33
P301E	Speaker Control Code - The control code value has 1-4 digits. This code cannot starts from 0, Used when accessing Serenity remotely.	99
P302E	System Arm Remote Control Code -The control code value has 1-4 digits. This code cannot starts from 0, Used when accessing Serenity remotely.	5555

Address	Description – Maximum 4 digits per code /	Default
P303E	System stay Arm Remote Control Code - The control code value has 1-4 digits. This code cannot starts from 0, Used when accessing Serenity remotely.	6666
P304E	System Disarm Remote Control Code - The control code value has 1-4 digits. This code cannot starts from 0, Used when accessing Serenity remotely.	7777
P305E	Area Arm Remote Control Code - The control code value has 1-4 digits. This code cannot starts from 0, Used when accessing Serenity remotely.	Area 1 = 41 : Area 4 = 44
P306E	Area stay Arm Remote Control Code - The control code value has 1-4 digits. This code cannot starts from 0, Used when accessing Serenity remotely.	Area 1stay = 51 : Area 4stay= 54
P307E	Area disarm Remote Control Code - The control code value has 1-4 digits. This code cannot starts from 0, Used when accessing Serenity remotely.	Area 1disarm = 61 : Area 4 disarm = 64

11: Miscellaneous

11.0: Miscellaneous/Chime Control

Address	Description	Default
P308E	Chime Alarm Beeps to Keypad - If a zone is programmed as a Chime zone and it activates, the zone can sound the buzzer at Selected keypads for local alarm signaling. The duration of the Chime beep is programmed at location P309E. The Chime function can also be locally disabled at each keypad individually if not required.	Disable
P309E	Chime Alarm Beep Time on Keypad - When a Chime Zone is activated it can operate an Output and/or beep the keypad buzzer. There is a separate Chime timer for each of the 8 keypads. If the value is made '0' for a keypad the Chime Zone will not beep the keypad buzzer. The Keypad Chime Timer can be set to a value from 1-255. The units are in 1/10th second increments. This means that a value of 10 will beep the keypad buzzer for 1 second	10
P1160E	Chime zone alarm assigned to output - If a zone is programmed as a Chime zone (P123E7E) and it activates, the zone can trigger selected Outputs for local alarm signaling. The output will operate for the Chime to Output time at location P41E. The zone must clear before the output can be activated again	Disable

11.1: Miscellaneous/Panel Options

Address	Description	Default
P310E	Installer Code - This code is used to enter full Installer Programming mode. The default installer code is 000000. The Installer Code must be between 4-8 digits in length if parameter is enabled in (P327)	6 X 0' (000000)
P311E	Duress Digit - The duress digit can be a number from 1-9 (a	0

Address	Description	Default
	value of '0' means the duress function is disabled). To create a duress alarm the duress digit must be entered before a valid user code (eg If the code was '123' and the duress number was '4', then entering a code of '4123+ ENTER' would create a duress alarm). Any user code or time-zone password cannot starts with this digit for right duress recognition.	
P312E	Disable mains fail test - If the panel must be run off a DC supply or the Mains supply fails regularly, this option disables the mains voltage monitoring to prevent mains fail alarms from occurring	Disable
P313E	Direct access to program mode for installer code - If this option is on, the Installer Code can gain access to Installer Program Mode directly. If the option is turned off, the installer can only gain access to Installer Program Mode via User Program Mode. This option allows the owner to control program mode access by the installer. The User must have option at location [P23] turned on for them to allow installer access.	Enable Available on User programming Mode only
P314E	Turn voice guide on/off - Voice guide is speech messages, played by control panel on local speaker.	Enable
P315E	Installer Lockout - When this option is enabled, this way of entering installer mode is blocked, so the only way to get to installer mode is by entering the installer code.	Disable
P318E	Buzzer Reset Time - This feature controls the Buzzer operation time when an event occurred. The value in minutes, range from 1 to 255 minutes.	1
P319E	Config mode resets confirmed alarms - If this option is turned on and a Confirmed alarm has occurred, the alarm cannot be re-armed until the Installer has reset the alarm. The zones that caused the alarm will latch on (even when disarmed) until reset by the installer to indicate that lockout is in effect.	Disable
P320E	Config mode resets tamper alarms - If this option is turned on and a Tamper alarm has occurred (system or zone tampers), the alarm cannot be re-armed until the Installer has reset the alarm. The Trouble indication will latch on (even if the tamper alarm has been cleared) until reset by the installer to indicate that lockout is in effect.	Disable
P321E	Config mode resets low battery alarms - If this option is turned on and a Low Battery alarm has occurred, the Installer must access Installer Program Mode to reset the battery low alarm signal.	Disable
P322E	Config mode resets supervise alarms - If this option is turned on and a Detector Supervisory alarm has occurred, the alarm cannot be re-armed until the Installer has reset the alarm.	Disable
P323E	Cannot arm if the system battery is low or AC Fail - if this option is turned ON, the panel cannot be armed if the panel battery is low or the AC has failed. When the battery is fully charged or the AC has returned, the panel can then be armed. If this option is turned off, the panel can be armed during these fault conditions.	Disable
P324E	Cannot arm when keypad fault - if this option is turned ON and a missing keypad alarm is present, the panel cannot be armed	Disable

Address	Description	Default
	until the keypad has been reinstalled.	
P325E	Cannot arm when communication fault - If this option is turned on and the control panel has detected a communication fault (telephone line, Ethernet or GSM) panel cannot be armed. To reset the failure the line must be re-instated to allow arming again.	Disable
P326E	Keypad locks for 90 sec after 10 code attempts - If this option is turned on and after 10 incorrect codes are entered the keypad will be locked out for 90 seconds, but Panic/Fire/Medical keys will stay unlocked and free for use.	Enable
P327E	User code must be 4-8 digits long - If this option is turned on, all user codes, installer code and remote access password must be between 4-8 digits long. If it is turned off, the minimal length of the code is one digit.	Disable
P328E	Enable Keypad Tamper - if this option is turned ON the keypad tamper will be enabled and can cause to keypad tamper alarm if keypad is removed from the wall. If this option is OFF, then the keypad tamper will be disabled, opening or removing the keypad from the wall will not cause to tamper alarm on panel.	Disable
P329E	Enable Outputs Tamper - Tamper alarm indication for any device which is connected to Control Panel's output.	Enable
P330E	Maximum of report messages from a single source - The maximum number of events recorded from any single source. The value is limited from 3 to 10. The memory will show (recorded) events from the blocked single source after a system session has occurred (Arm-Disarm or Disarm-Arm)	10
P376E	Control panel title - Enter identification title of control panel up to 16 characters	SERENITY
P389E	Switch out 12V on - Switch on/off 12V on output connector using for peripherals	Enable
P397E	EN Compliance – Enable/Disable of EN-50131 (e.g. when EN COMPLIANCE is Off, pendant low battery will not change area "ready to arm" status , system can be arm in a "pendant low battery" trouble event.	Disable

11.2: Miscellaneous/User Options

Address	Description	Default
P331E	Code Required to View Memory and status - If this option is turned on, access to view Memory Log, Status Window and Active Time Zones while the Serenity is in disarm mode will only be allowed by using an authorized code. If this option is turned off anyone can access the modes at disarm. In any case, while Serenity is in arm or stay arm mode an authorized code is required to view memory.	Disable
P332E	Hide user codes from installer - This option is only accessible from User Programming Mode. It is designed to allow the User (owner) of the alarm to hide their User Codes from the Installer if desired. If this option is turned On, codes can only be changed or viewed in User programming mode. Users MUST have option at	Disable

Address	Description	Default
	location [P22] assigned before they can hide the user codes.	
P333E	Cancel Handover Zone Function in Stay Mode - If this option is turned on, any zone programmed with the handover feature will act as a normal delayed zone during Stay mode (i.e. the handover feature will be ignored). The zone will still have the normal handover feature during the full arm state.	Disable
P334E	Output Control from Keypad is Disabled when Armed - If this option is turned on any User code programmed to operate an output for access control will be disabled when the area(s) assigned to the user is(are) armed (P14). If the user code is assigned to area 1 but area 2 was armed the code can still operate the output.	Disable
P335E	Keypad Codes are Disabled During Entry Delay - If this option is turned on no codes will operate during the entry delay. This forces the user to disarm before entering the premises.	Disable

11.3: Miscellaneous/Voice Mail at Disarm

Address	Description	Default
P336E	Do not play voice mail after disarm - This feature is relevant only if a voice message was pre-recorded at the "voice mail" main menu programming level (this refers to P337 and P338 address as well). Pre-recorded message will not be played after disarm action on the control panel.	Enable
P337E	Always play voice mail after disarm - This feature is relevant only if a voice message was pre-recorded at the "voice mail" main menu programming level (this refers to P336 and P338 address as well). Pre-recorded message will be played after every disarm action on the control panel.	Disable
P338E	Play voice mail once after disarm - This feature is relevant only if a voice message was pre-recorded at the "voice mail" main menu programming level (this refers to P336 and P337 address as well). Pre-recorded message will be played after disarm action on the control panel only once.	Disable

11.4: Miscellaneous/Diagnostic

Address	Description	Default
P339E	Local Keypad Number - This location gives possibility to change the keypad number for any keypad, excluding internal Control Panel keypad. Control panel number is always 1. You can only change the number of the keypad currently used (between numbers 2-8). Note: each keypad has its own configurations in the Serenity, so if you change a keypad's number you must adjust the configurations.	Disable
P340E	Factory Defaults - This location is used to return all configuration parameters to the factory default settings.	Disable

Address	Description	Default
P361E	Restart Panel - This location is used to restart the panel	Disable
P342E	Battery Voltage - This location will display the system battery voltage measured by the panel.	Disable
P343E	Walk Test - This address is used to start walk-test mode while in installer or user program mode. By walking past all of the detectors connected to the system and activating them, the associated zone will latch up at the keypad to allow verification that all zones are working properly. By pressing Enter or Cancel button, walk-test mode will be terminated. The results of the walk-test will be showed on the screen to verify which detectors were triggered during walk-test mode. (See more important information on page 72)	Disable
P344E	RSSI Test - Using this option can help you to measure the signal strength from the wireless device and help you to decide where to place it.	Disable
P345E	RF Module version – This location displays the version, baud rate and base frequency of internal RF module.	Disable
P346E	GSM Module Info - This location displays the GSM module information such as RSSI, Provider Name and module State.	Disable
P347E	Ethernet Module Info - This location displays the Ethernet module details such as IP address, Subnet mask address, Gateway address and MAC address. xx	Disable
P348E	Manual Test Call - This option tests the specified report channel.	Disable

11.5: Miscellaneous/Extender Type

Address	Description	Default
P349E	Zone extender - (TBD)	Enable
P350E	Output extender - (TBD)	Disable

11.6: Miscellaneous/Extender Options

Address	Description - (TBD)	Default
P351E	Zone Mapping - (TBD)	Disable

Important Notes: (P343)

Note 1. Use the four buttons (see the picture below) in zone walk test mode to move the cursor between the zones in order to display the RSSI value while in zone test.

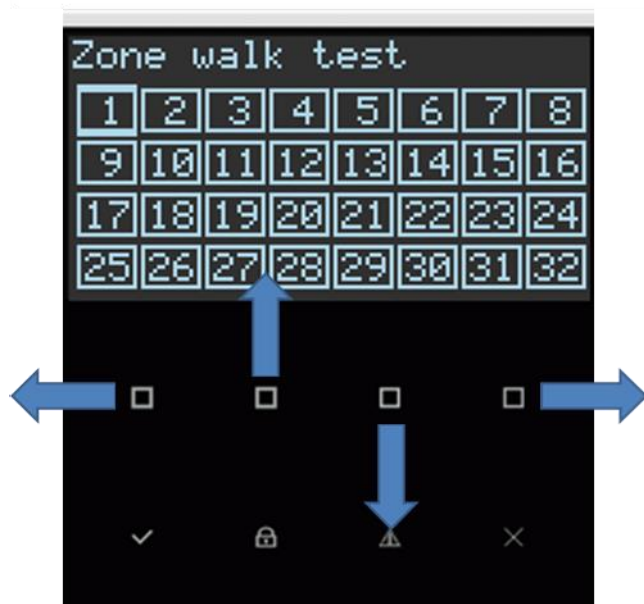

Note 2. Voice message report via PSTN or GSM

On receiving an incoming call of voice report via PSTN or GSM , the user should not answer the call with the phone speaker, otherwise any background noise such as, people talk ,radio ... the panel will stop the report. if the user will stay on line and the panel will not disturb by background noise ,the panel will transmit the report in the next cycle.

Note 3. Upload configuration to panel via GPRS mode

Wait at least 30 seconds after "Upload configuration to panel" action when Easyserenity pc application remote connection controlling the panel via GPRS communication, and before disconnect from the panel otherwise the panel will not upload the new configuration.

89CROW ELECTRONIC ENGINEERING LTD. (Crow) WARRANTY POLICY CERTIFICATE

This Warranty Certificate is given in favor of the purchaser (hereunder the "**Purchaser**") purchasing the products directly from Crow or from its authorized distributor.

Crow warrants these products to be free from defects in materials and workmanship under normal use and service for a period of 24 months from the last day of the week and year whose numbers are printed on the printed circuit board inside these products (hereunder the "**Warranty Period**").

Subject to the provisions of this Warranty Certificate, during the Warranty Period, Crow undertakes, at its sole discretion and subject to Crow's procedures, as such procedures are from time to time, to repair or replace, free of charge for materials and/or labor, products proved to be defective in materials or workmanship under normal use and service. Repaired products shall be warranted for the remainder of the original Warranty Period.

All transportation costs and in-transit risk of loss or damage related, directly or indirectly, to products returned to Crow for repair or replacement shall be borne solely by the Purchaser.

Crow's warranty under this Warranty Certificate does not cover products that is defective (or shall become defective) due to: (a) alteration of the products (or any part thereof) by anyone other than Crow; (b) accident, abuse, negligence, or improper maintenance; (c) failure caused by a product which Crow did not provide; (d) failure caused by software or hardware which Crow did not provide; (e) use or storage other than in accordance with Crow's specified operating and storage instructions.

There are no warranties, expressed or implied, of merchantability or fitness of the products for a particular purpose or otherwise, which extend beyond the description on the face hereof.

This limited Warranty Certificate is the Purchaser's sole and exclusive remedy against Crow and Crow's sole and exclusive liability toward the Purchaser in connection with the products, including without limitation - for defects or malfunctions of the products. This Warranty Certificate replaces all other warranties and liabilities, whether oral, written, (non-mandatory) statutory, contractual, in tort or otherwise.

In no case shall Crow be liable to anyone for any consequential or incidental damages (inclusive of loss of profit, and whether occasioned by negligence of the Crow or any third party on its behalf) for breach of this or any other warranty, expressed or implied, or upon any other basis of liability whatsoever. Crow does not represent that these products can not be compromised or circumvented; that these products will prevent any person injury or property loss or damage by burglary, robbery, fire or otherwise; or that these products will in all cases provide adequate warning or protection.

Purchaser understands that a properly installed and maintained product may in some cases reduce the risk of burglary, fire, robbery or other events occurring without providing an alarm, but it is not insurance or a guarantee that such will not occur or that there will be no personal injury or property loss or damage as a result.

Consequently, Crow shall have no liability for any personal injury; property damage or any other loss based on claim that these products failed to give any warning.

If Crow is held liable, whether directly or indirectly, for any loss or damage with regards to these products, regardless of cause or origin, Crow's maximum liability shall not in any case exceed the purchase price of these products, which shall be the complete and exclusive remedy against Crow.

