

Three-Phase Smart Energy Meter Quick Installation Guide DTSU666-20

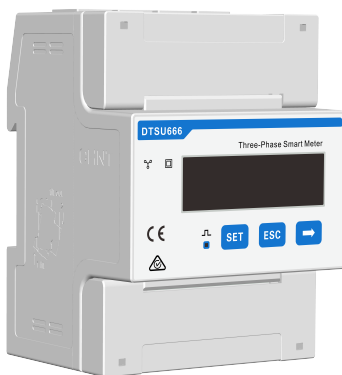

Applicability

This manual is applicable to Sungrow Three-phase Smart Energy Meter.

- DTSU666-20

Keep the manual in a convenient place for future reference. The latest manual can be acquired at support.sungrowpower.com.

Target Group

Only qualified personnel with the following skills are allowed to perform the work described in this document:

- Training in the installation and commissioning of the electrical systems.
- Capable of coping with the dangerous and emergency situations during the installation and commissioning.
- Familiar with the country/regional standards and specifications.
- Knowledge of and compliance with this manual and other related documents.

Intended Use

- The Smart Energy Meter is designed for indoor use only. It is a measuring device detecting the electrical values at the grid-connected point. It cannot be used for billing purposes. The data collected by the Smart Energy Meter on the PV power generation may differ from the data of the main Smart Energy Meter.
- Any use other than those described in this document does not qualify as appropriate usage and is prohibited. Do not make any modifications to the product.
- Damage or destruction may be caused to the Smart Energy Meter due to inappropriate usage. The Smart Energy Meter must not be operated beyond the values specified in the technical data.
- The following figure shows an application example of the Smart Energy Meter in the PV system. The inverter figure is for your reference only.

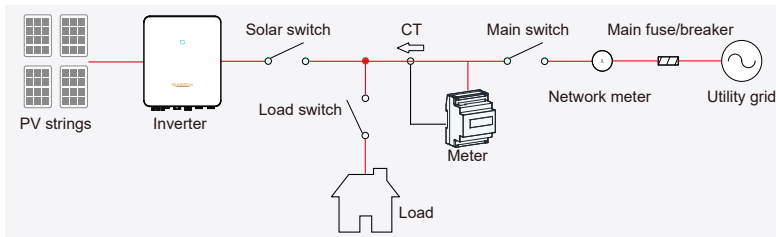
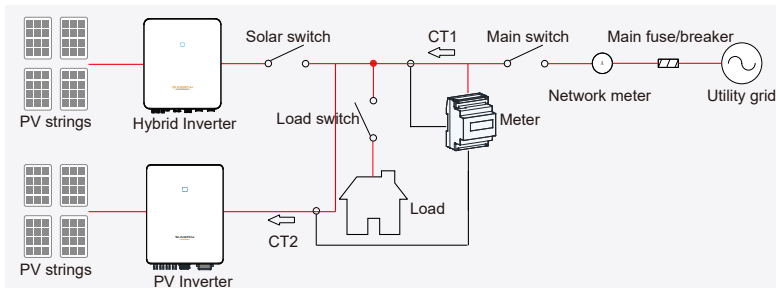

DANGER

Lethal voltages and danger to life due to electric shock!

- Only use the Smart Energy Meter in a dry environment and keep it away from liquids.
- Install the Smart Energy Meter in the switch cabinet only and ensure that the connection areas for the line and the neutral conductors are behind an insulating cover or have contact protection.
- Install an external disconnect switch between the Smart Energy Meter and the grid-connection point. The external disconnecter must be close to the Smart Energy Meter and easily accessible.
- Disconnect the Smart Energy Meter from voltage sources before cleaning. The Smart Energy Meter must be cleaned with a dry cloth only.

WARNING

Fire hazard !

- If a fuse is missing or incorrect, a fire may be caused when a fault occurs. This can result in death or serious injury.

Technical Data

Parameters	DTSU666-20
Nominal voltage	230/400Vac
Input voltage range	320Vac ... 460Vac
Current Transformer	***0.333V
Grid frequency	50Hz/60Hz
Operating temperature	-25 °C ... +70 °C
Relative humidity	< 75% (non-condensing)
Dimensions (W x H x D)	118 x 72 x 65.5 mm

Delivery Contents

Related components in the scope of delivery:

- Smart Energy Meter
- RS485 cable *
- Quick installation guide

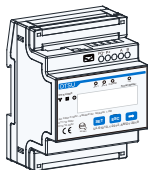

DTSU666-20

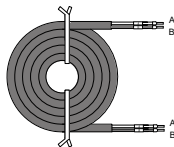

RS485 cable



Quick guide

* The RS485 cable is included in the accessories of the meter or the inverter.

NOTICE

Contact SUNGROW or the distributor in case of any damaged or missing components.

Three-phase Smart Energy Meter dimensions

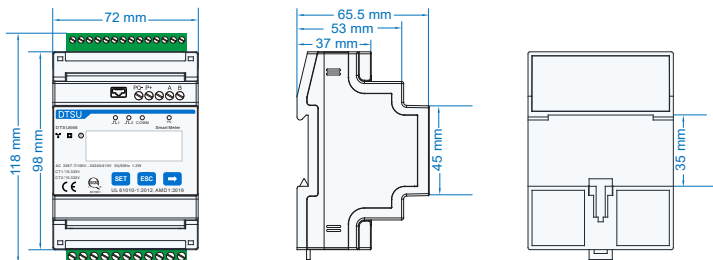

100 A CT dimensions

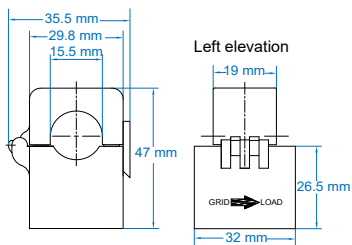

250 A CT dimensions

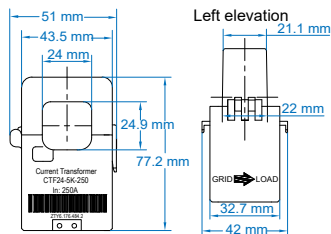

* The current transformer (CT) is shipped separately or with the inverter.

Three-phase Smart Energy Meter and its terminals

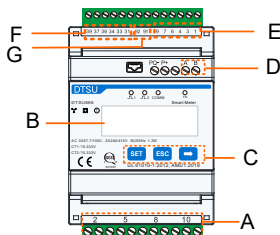

Designation		Description
A	2, 5, 8, 10	Output terminals to the load side
B	LCD display	Displays active energy and reactive energy, etc
C	Key	SET: confirm the selection or settings ESC: return to a previous menu or cancel the settings →: increase the setting value
D	A, B	Communication terminals
E	1, 3, 4, 6, 7, 9	CT1 Current Input
F	31, 33, 34, 36, 37, 39	CT2 Current Input
G	91	Power supply of Rogowski coil (5V)

Installation

Mount the Smart Energy Meter to a 35 mm DIN rail. Hook it into the top edge of the rail and press down until it snaps into place.

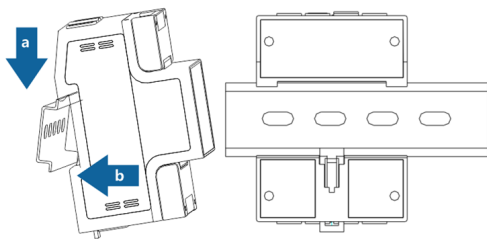

Cable Connection

- The line conductor L1 supplies power to the Smart Energy Meter. The line conductor L1 and neutral conductor must be connected to the terminal 2 and terminal 10 of the Smart Energy Meter respectively.
- If there is only L1 (to terminal 2), or L2 (to terminal 5), or L3 (to terminal 8), and the neutral conductor (to terminal 10), then the three-phase Smart Energy Meter can be used as a single-phase Smart Energy Meter.

Step 1 Turn off solar switch, load switch, main switch and other power switches, and secure them against reconnection.

Step 2 Take out the RS485 cable from inverter's packaging or Smart Energy Meter's packaging .

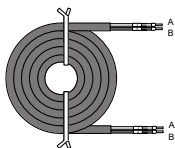

2

Step 3 Connect the plugs A and B to terminals A and B on the Smart Energy Meter.

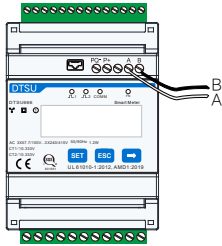

Step 4 Strip the insulation from the power wires by 10 mm. Then connect wires to the terminals on the Smart Energy Meter, as shown below. (Cross-section: 1mm² to 6mm²)

Retrofit (Three-phase hybrid inverter + Three-phase PV inverter + Three-phase grid)

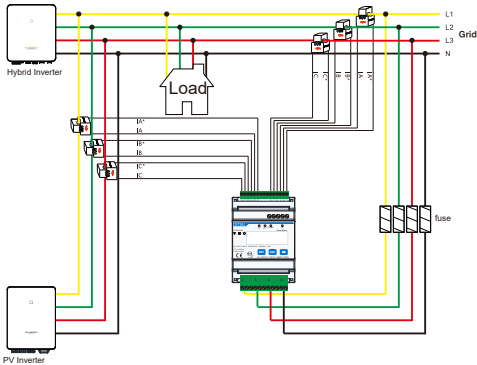

Retrofit (Three-phase hybrid inverter + Single-phase PV inverter + Three-phase grid)

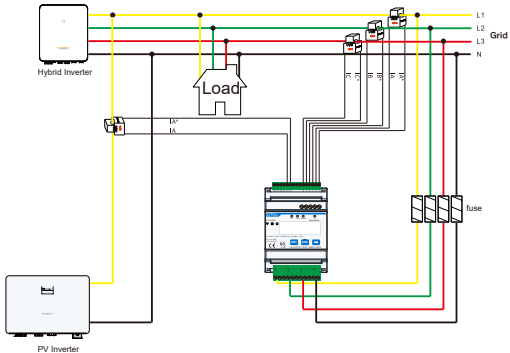

Retrofit (Single-phase hybrid inverter + Single-phase PV inverter + Single-phase grid)

Note:

Connect CT1 to terminal 1 and terminal 3 of the smart energy meter, and CT2 to terminal 31 and terminal 33.

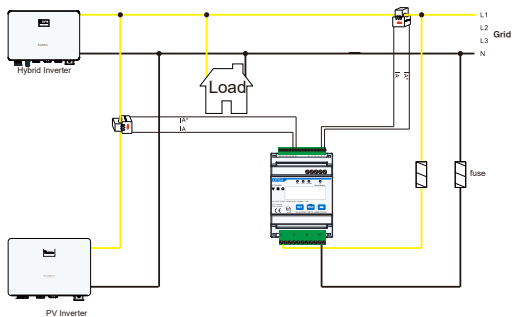

For details about the installation direction and cable connection of the current transformer, please refer to the information on the side of the current transformer.

NOTICE

- The CT direction must be consistent with the arrow direction as shown in the preceding figure.
- The maximum torque of 2, 5, 8 and 10 terminal screws is 1.7N.m, and the recommended torque is (1.0 ± 0.1) N.m; The maximum torque of 13, 14, 16, 17, 19, 21, 24 and 25 terminal screws is 0.4N.m, and the recommended torque is (0.20 ± 0.05) N.m.

Step 5 For inverter cable connection, refer to the user manual of the corresponding inverter.













Step 6 Cover the Smart Energy Meter with the insulating cover or contact protection of the sub-distribution. Switch on the power supply to the sub-distribution.

Displayed function

From the displayed interface, the electrical parameter and energy data are all primary side data (that is, the multiplied by current and voltage ratios). The energy measuring value will be displayed seven bits, with the displaying range from 0.00kWh to 9999999MWh.



No.	Display interface	Instruction	No.	Display interface	Instruction
1		Protocol: Modbus-RTU address=001 Baudrate=9600	16		First channel Combined phase power factor PFc=-0.500
2		None parity, 1 stop bits	17		Second channel Phase A voltage =220.0V
3		First channel Phase A voltage =220.0V	18		Second channel Phase A voltage =220.1V
4		First channel Phase A voltage =220.1V	19		Second channel Phase A voltage =220.2V
5		First channel Phase A voltage =220.2V	20		Second channel Phase A voltage =5.000A
6		First channel Phase A voltage =5.000A	21		Second channel Phase A voltage =5.001A
7		First channel Phase A voltage =5.001A	22		Second channel Phase A voltage =5.002A
8		First channel Phase A voltage =5.002A	23		Second channel Combined phase active power =3.291kW
9		First channel Combined phase active power =3.291kW	24		Second channel Combined phase active power =1.090kW

10		First channel Combined phase active power =1.090kW	25		Second channel Combined phase active power =1.101kW
11		First channel Combined phase active power =1.101kW	26		Second channel Combined phase active power =1.100kW
12		First channel Combined phase active power =1.100kW	27		Second channel Combined phase power factor PFt=0.500
13		First channel Combined phase power factor PFt=0.500	28		Second channel Combined phase power factor PFa=1.000
14		First channel Combined phase power factor PFa=1.000	29		Second channel Combined phase power factor PFb=0.500
15		First channel Combined phase power factor PFb=0.500	30		Second channel Combined phase power factor PFc=-0.500

- The communication address of Modbus protocol is 1 decimal data (1 ~ 254), and the factory default baud rate is 9600bps, N.8.1; E1 means even check one stop bit, O1 means odd check one stop bit, N2 means two stop bits without check, N1 means one stop bits without check.
- When RS485 communicating, the telephone sign will flashes.

Programming function

The meter parameters have been set before delivery. It can be installed directly after acceptance and there is no need to set parameters again.

Programming Parameter

Parameter	Value range	Description
Ct	1 ~ 88	1: CT01:100A/333mV 2: CT02:250A/333mV 3: CT03:400A/333mV 4: CT04:500A/333mV 5: RS01:1000A/333mV 6: RS02:2000A/333mV 7: RS03:3000A/333mV 8: RS04:4000A/333mV
Pt	0.1 ~ 1.0	Voltage ratio, used for setting the voltage ratio of the input loop. When the voltage is connected to the line via the transformer, Pt= the rated voltage of the primary loop / the rated voltage of the secondary circuit. When the voltage is directly connected to the line, Pt shall be set as 1.0.
$Prot$	1: 645 2: n.2 3: n.1 4: E.1 5: O.1	Settings for communication stop bit and Parity: bits 1: 645mode 2: None parity, 2 stop bits, n.2 3: None parity, 1 stop bit, n.1 4: Even parity, 1 stop bit, E.1 5: Odd parity, 1 stop bit, O.1
$bAud$	0: 1.200 1: 2.400 2: 4.800 3: 9.600	Communication baud rate: 0: 1.200 bps 1: 2.400 bps 2: 4.800 bps 3: 9.600 bps
$Addr$	1 ~ 254	Communication address
nEt	0: n.34 1: n.33	Option for wiring mode: 0: n.34 represents three phase four wire 1: n.33 represents three phase three wire
$PLuS$	0: P0 1: P1	Pulse output: P0: First channel active energy pulse P1: Second channel active energy pulse
$dISP$	0 ~ 30	Display in turns(second) 0: Timely display 1 ~ 30: Time interval of actual display
$bLcD$	0 ~ 30	Backlight lighting time control(minute) 0: Normally light 1 ~ 30: Backlight lighting time without button operation

Programming Parameter

Button description: "SET" represents "confirm" or "cursor shift" (when input digits), "ESC" represents "exit", and "→" represents "add". The password is 701 by default.

