

# HPW2P1 WDR 1080P Pin-hole Camera





## Quick Installation Guide

Thank you for purchasing a Honeywell Performance Series IP camera. Follow the instructions in this guide to install and log in to your camera. For instructions on configuring the camera, refer to the *Performance Series IP Cameras User Guide* on the installation CD that came with your camera.

If you require additional assistance, contact Tech Support (contact info is listed on the back page).



## Cautions and Warnings

|  |  |   |   |   |
|--|--|---|---|---|
|   | <p><b>CAUTION</b><br/>RISK OF ELECTRIC SHOCK<br/>DO NOT OPEN</p> |  |                        | <p>THIS SYMBOL INDICATES THAT DANGEROUS VOLTAGE CONSTITUTING A RISK OF ELECTRIC SHOCK IS PRESENT WITHIN THE UNIT.</p> |
| <p>CAUTION: TO REDUCE THE RISK OF ELECTRIC SHOCK, DO NOT REMOVE THE COVER. NO USER-SERVICEABLE PARTS INSIDE. REFER SERVICING TO QUALIFIED SERVICE PERSONNEL.</p> |  |  | <p>THIS SYMBOL INDICATES THAT IMPORTANT OPERATING AND MAINTENANCE INSTRUCTIONS ACCOMPANY THIS UNIT.</p> |   |

**WARNING** To ensure compliance with electrical safety standards, this product is intended for use with a Listed Power Adapter marked “Limited Power Source” or “LPS” on the unit, output rated to 12 VDC, minimum 0.33 A, TMA=60 deg C, or from Power over Ethernet (PoE) provided by Listed Information Technology Equipment meeting IEEE 802.3af PoE standard.

**WARNING** The Ethernet connection is not intended to be connected to exposed (outside plant) networks. Do not connect two power sources to the camera at the same time.

**CAUTION** Invisible LED radiation (850 nm). Avoid exposure to beam.

## Important Safeguards

- Read and keep these instructions.
- Do not aim the camera toward a bright light source for extended periods to prevent damage to the imager. Avoid operating the unit under or close to unstable light sources (may cause flickering), or close to fluorescent lamps or objects reflecting light.
- Do not touch the camera lens.
- Do not drop the camera or subject it to physical shock.
- Do not use a strong or abrasive detergent when cleaning the camera.

- Avoid operating or storing the unit in extremely humid, dusty, hot/cold environments, where the operating temperature is outside the recommended range of -22°F to 140°F (-30°C to 60°C).

**Note** Do not apply power to the camera before completing installation.

Confirm the installation surface can support at least three times the weight of the camera.

## Before You Begin

Before you begin, check that you have received all of the parts listed below. If any parts are missing or damaged, contact your dealer immediately.

- Camera
- Quick installation guide
- Installation CD

## Preparing the Mounting Surface and Mounting the Camera

Inspect the site where you want to install the camera. The mounting surface must be flat and capable of supporting at least three times the weight of the camera.

1. Install the camera together with the bracket on the mounting surface and secure the installation screws firmly.
2. Connect the camera’s connectors to power, network and audio in/out.
3. Adjust the camera angle and tighten the adjusting screws.

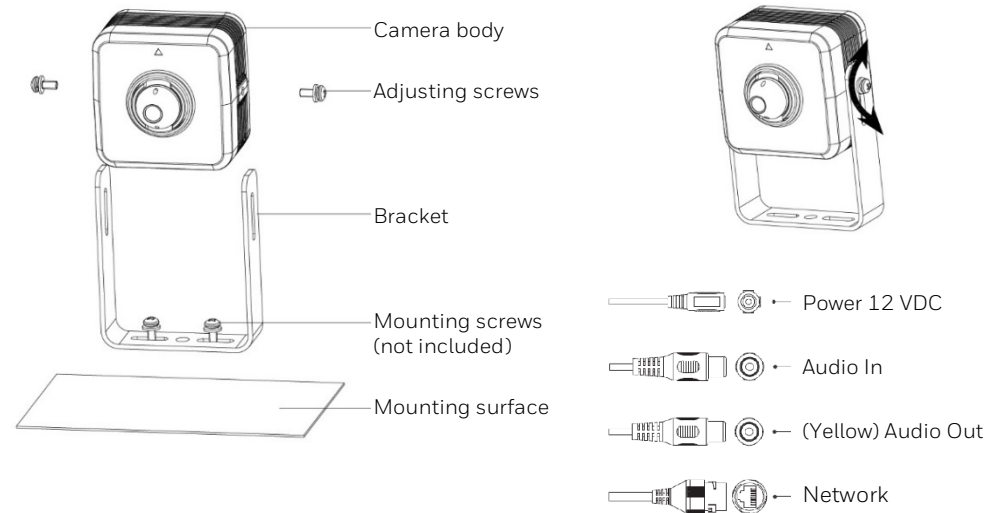

## Logging On to the Camera

If the camera is connected to the PoE port of a Honeywell Embedded NVR, you can log on to the camera directly from the NVR.

To log on to the camera from a PC, install the Honeywell Config Tool from the installation CD. Use the Config Tool to discover the camera and open the camera's webpage. Log on to the camera as the admin user. The default user name is **admin** (case-sensitive) and the default password is **1234**.

- Note**
- Be sure to remember the password of the camera. If the password is lost, the camera may need to be sent back to the factory for recovery.
  - Only Internet Explorer 11 (or later) is supported.
  - IP address of the device is assigned automatically by DHCP server. If the DHCP server is not available, the device will acquire **192.168.1.108** as the default IP address.

1. Power up the camera. To add the camera to NVR, right-click the live window on the main screen of NVR → **Registration**.
2. Click **Device Search**. Check the camera on Device Search panel and click **Add**.
3. Click **Modify** icon on Added Device panel.

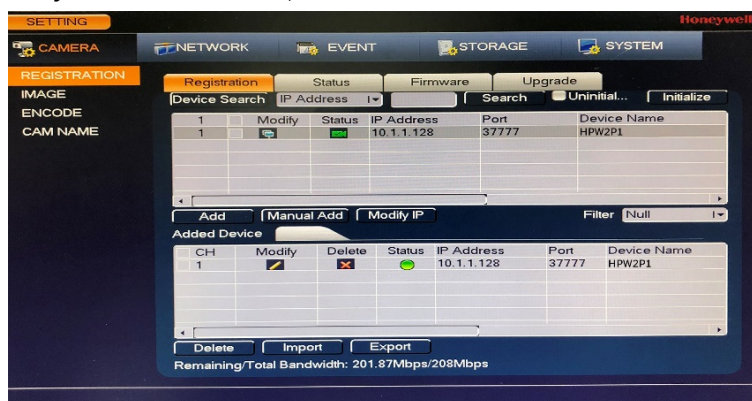

4. Select manufacturer as "Private" and enter the password.

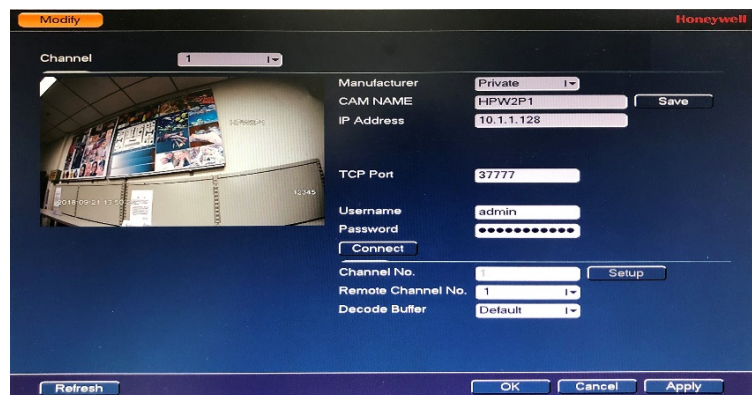

## Recommended Recorders

|       |   |
|-------|---|
| HEN*4 | 8/16/32/64-channel Focus 4K NVRs (H.264 and H.265)          |
| HEN*3 | 4/8/16/32-channel Performance Series NVRs (H.264 and H.265) |
| HEN*2 | 4/8/16-channel Performance Series NVRs (H.264)              |

## Regulatory Statements

### FCC Compliance

This equipment has been tested and found to comply with the limits for a Class B digital device, pursuant to part 15 of the FCC Rules. These limits are designed to provide reasonable protection against harmful interference in a residential installation. This equipment generates, uses, and can radiate radio frequency energy and, if not installed and used in accordance with the instructions, may cause harmful interference to radio communications. However, there is no guarantee that interference will not occur in a particular installation.

If this equipment does cause harmful interference to radio or television reception, which can be determined by turning the equipment off and on, the user is encouraged to try to correct the interference by one or more of the following measures:

- Reorient or relocate the receiving antenna.
- Increase the separation between the equipment and receiver.
- Connect the equipment into an outlet on a circuit different from that to which the receiver is connected.
- Consult the dealer or an experienced radio/TV technician for help.

**Note** Changes or modifications not expressly approved by the party responsible for compliance could void the user's authority to operate the equipment.  
This Class B digital apparatus complies with Canadian ICES-003.

### Manufacturer's Declaration of Conformance

**North America** The equipment supplied with this guide conforms to UL 60950-1 and CSA C22.2 No. 60950-1.

**Europe** The manufacturer declares that the equipment supplied is compliant with the European Parliament and Council Directive on the restriction of the use of certain hazardous substances in electrical and electronic equipment (2011/65/EU), General Product Safety Directive (2001/95/EC), and the essential requirements of the EMC directive (2014/30/EU), conforming to the requirements of standards EN 55032 for emissions, EN 50130-4 for immunity, and EN 62368-1 for electrical equipment safety.

### WEEE (Waste Electrical and Electronic Equipment)



Correct disposal of this product (applicable in the European Union and other European countries with separate collection systems). This product should be disposed of, at the end of its useful life, as per applicable local laws, regulations, and procedures.

# Honeywell

2700 Blankenbaker Pkwy, Suite 150  
Louisville, KY, 40299, USA  
[www.honeywell.com/security](http://www.honeywell.com/security)  
+1 800 323 4576  
(North America only)

Aston Fields Road, Whitehouse Industrial  
Estate Runcorn, Cheshire, WA7 3DL, UK  
[www.honeywell.com/security/uk](http://www.honeywell.com/security/uk)  
+1 44 (0) 1928 754 028  
(Europe only)

Building #1, 555 Huanke Road, Zhang Jiang Hi-Tech  
Park, Pudong New Area, Shanghai, 201203, China  
[www.asia.security.honeywell.com](http://www.asia.security.honeywell.com)  
+400 840 2233  
(Asia Pacific only)

Document 800-24590 – Rev B – 08/2018