

Quick Installation Guide

5GHz 11AC 23dBi Gigabit Outdoor CPE
ILBE-5AC

Package contents

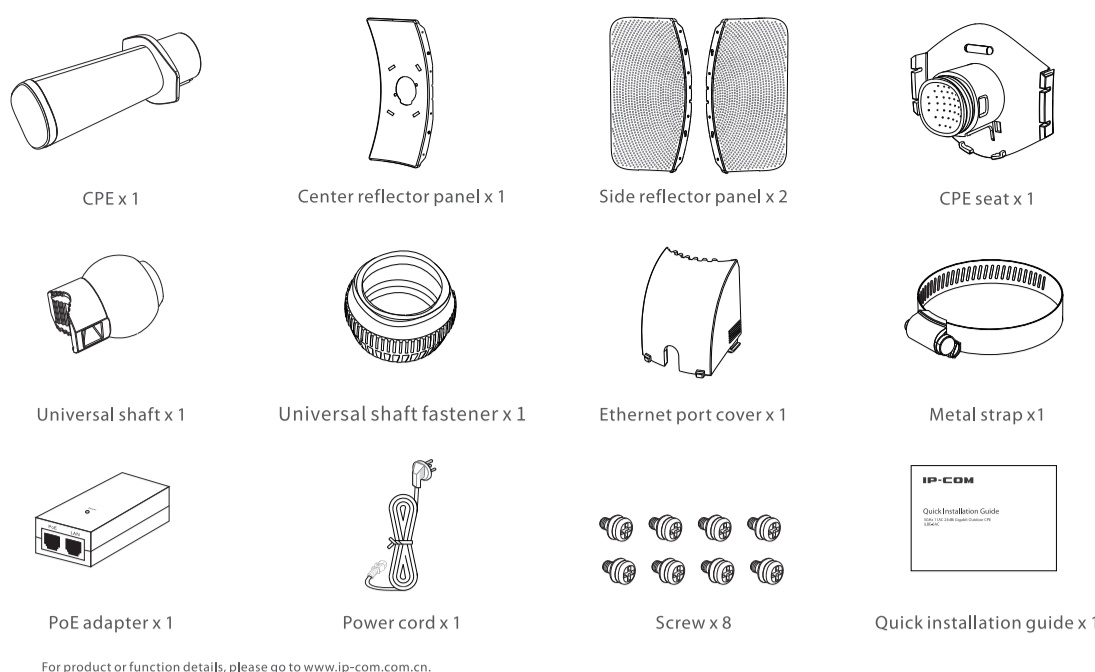

Get to know your device

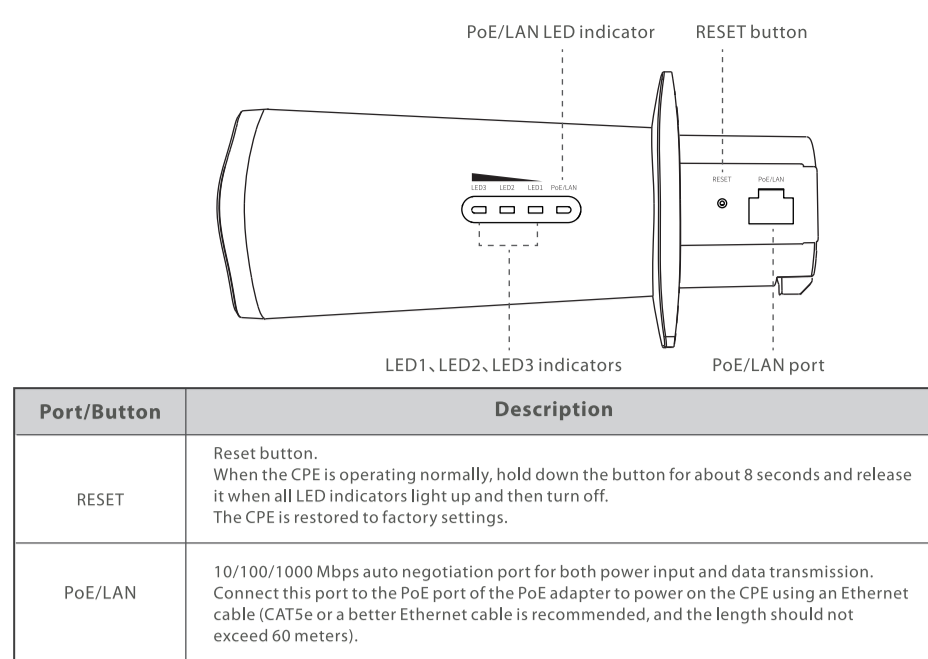

Indicator	Status	Description
LED1, LED2, LED3 (Received signal strength indicator)	Solid on/ Blinking	The CPE is successfully bridged or connected to other devices. -Solid on: The CPE works in AP, Repeater, P2MP or Router mode. -Blinking: The CPE works in Client, Universal Repeater or WISP mode. Each LED indicator is set with a received signal strength value, which is the threshold for the corresponding LED indicator to light up. You can judge the connection quality through the status of these indicators. The default values are shown below. You can change the values on the Wireless > Advanced page in the web UI of the CPE.
	Off	No device is connected to the CPE in a wireless manner, or the received signal strength does not reach the minimum value (90dBm by default) for any LED indicator to light up.
PoE/LAN	Solid on	The CPE is powered on properly, but no data is being transmitted.
	Blinking	The CPE is powered on properly, and data is being transmitted over the port.
	Off	The CPE is not powered on properly.

Assemble and install the CPE

Step1: Assemble the CPE.

Align the two bolts on one side of the center reflector panel with the long screw holes (the larger end) on the side reflector panel. Slide the center and side reflector panels in the opposite direction until the bolts fit into the smaller end.

Repeat Step 1 to fix another side reflector panel.

Align the slots of the CPE seat with the abutted edges of the center reflector panel and side reflector panels, and four hooks of the CPE seat with the four slots of the center reflector panel.

Note: When fixing the CPE seat, ensure that the orientations of IP-COM Logos on both the CPE seat and the front side of center reflector panel are the same.

Press the CPE seat to fit it to the center reflector panel.

Note: To prevent the deformation of the reflector panels and decreasing of bridging quality, DO NOT face the reflector panels down and put them on a desk or a horizontal plane while after fixing the CPE seat.

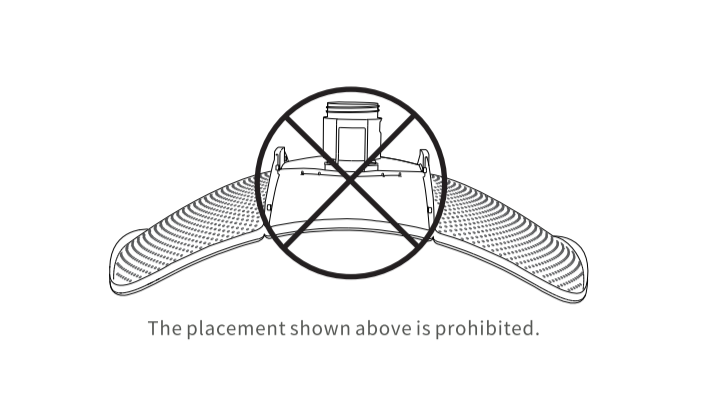
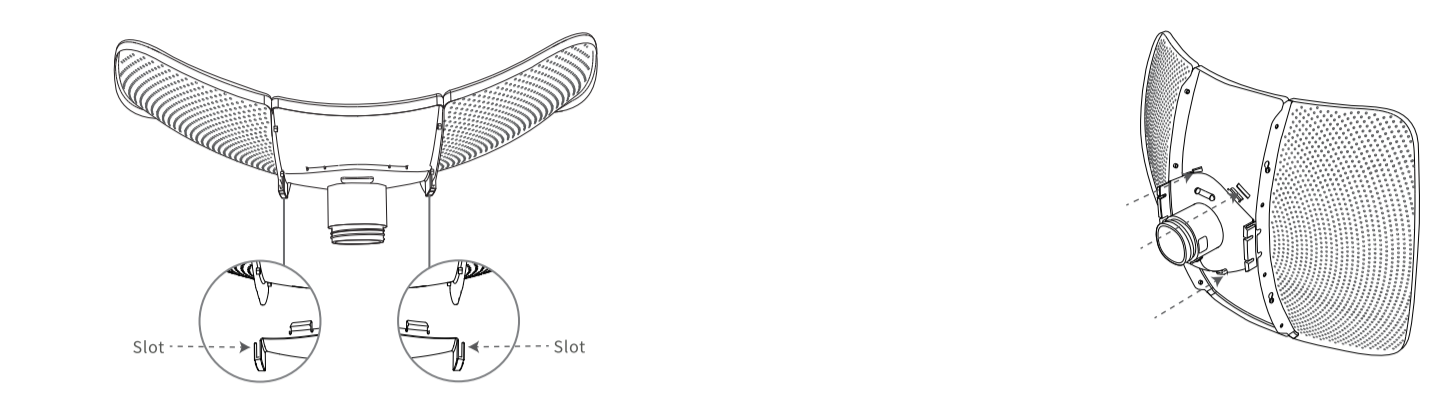
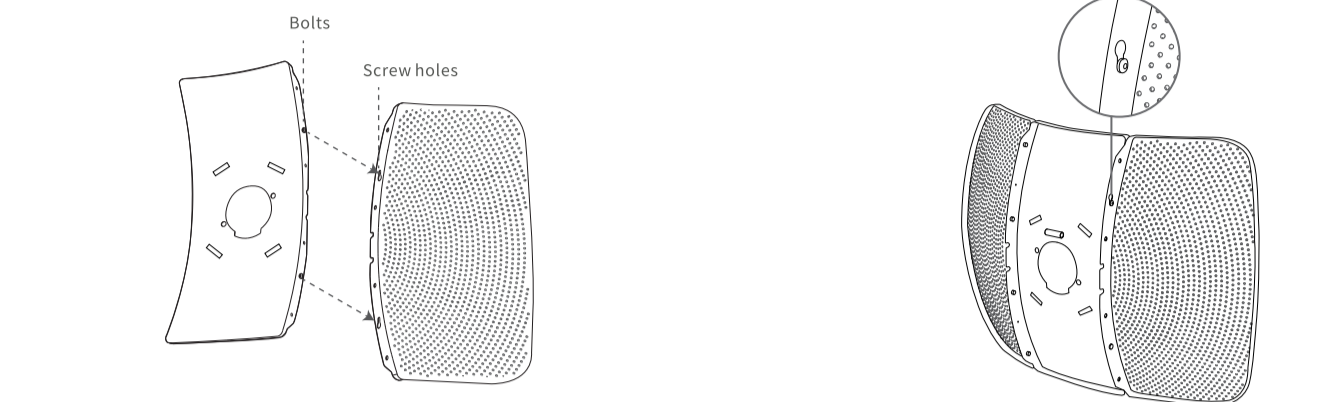

Fix the reflector panels with the included screws.

Insert the CPE into the CPE seat from the front side of the center reflector panel.

Use a screwdriver to open the metal strap by turning the screw counter-clockwise. Put the universal shaft into the universal shaft fastener and fix the universal shaft and universal shaft fastener on the pole using the metal strap (Connect the two ends of the metal strap and use the screw driver to adjust the tightness).

Direct the CPE seat at the universal shaft fastener, and screw the universal shaft fastener to fix the CPE (Ensure an appropriate tightness for you to adjust the orientation of the CPE later).
Connect the PoE adapter to a power source and its LAN port to the PoE/LAN port of the CPE using an Ethernet cable. The PoE/LAN LED indicator of the CPE lights up.

Adjust the orientation of the CPE to the horizontal with a spirit level. When the LED1, LED2 and LED3 indicators all light up after installation, it indicates that the best location is found.
Fasten the universal shaft fastener and fix the Ethernet port cover.

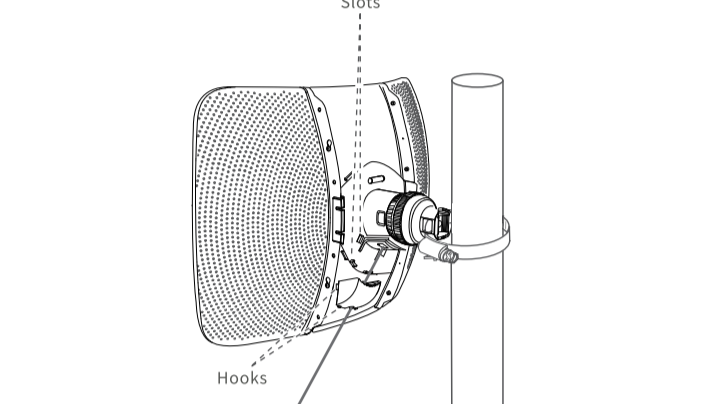
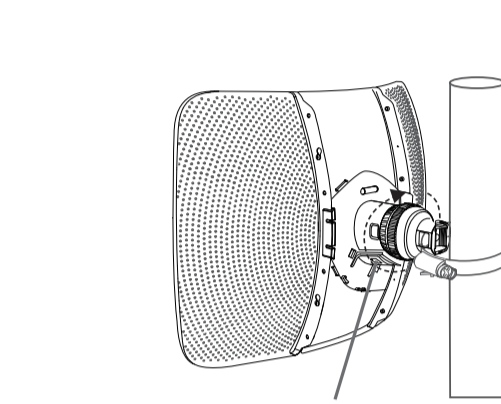
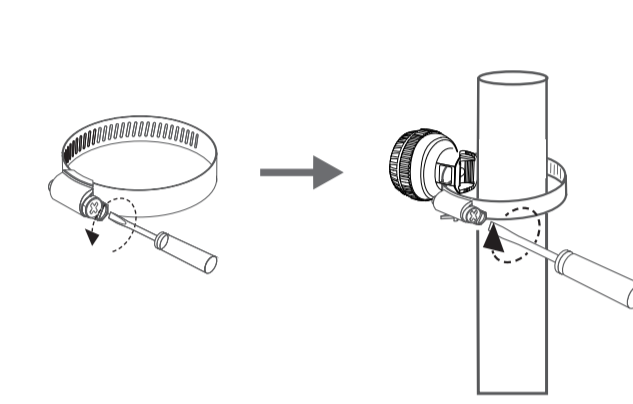

Scenario 1: CCTV surveillance or point to point data transmission

1. Set up the CPEs (AP mode + Client mode)

Option 1: Automatic bridging (recommended)

Automatic bridging only works for CPEs in factory settings.
When two or more CPEs are bridged, the IP address of the CPE in the Client mode is changed to 192.168.2.X.

Step1: Place two CPEs in factory settings next to each other.
Step2: Use Ethernet cables to connect the PoE/LAN port of the CPEs to the PoE port of the PoE adapters.
Step3: Use the included power cords to connect the PoE adapters to power sources. The PoE/LAN LED indicators of the two CPEs light up.

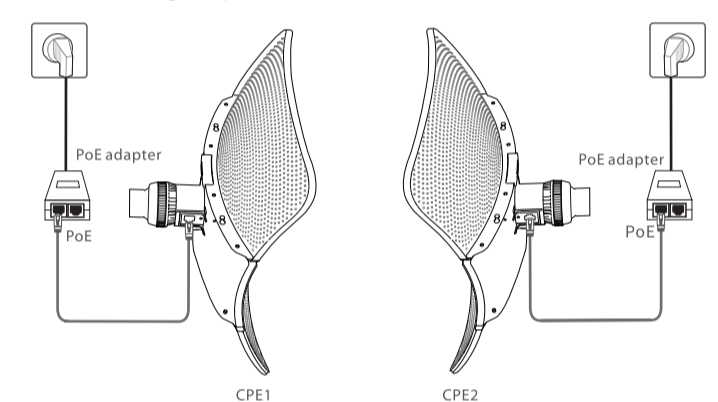

Option 2: Manual bridging

The LED1, LED2 and LED3 indicators of the two CPEs blink fast. When the LED1, LED2 and LED3 indicators of one CPE light solid on and those of the other CPE blink slow, the automatic bridging succeeds.

Step1: Place two CPEs next to each other.

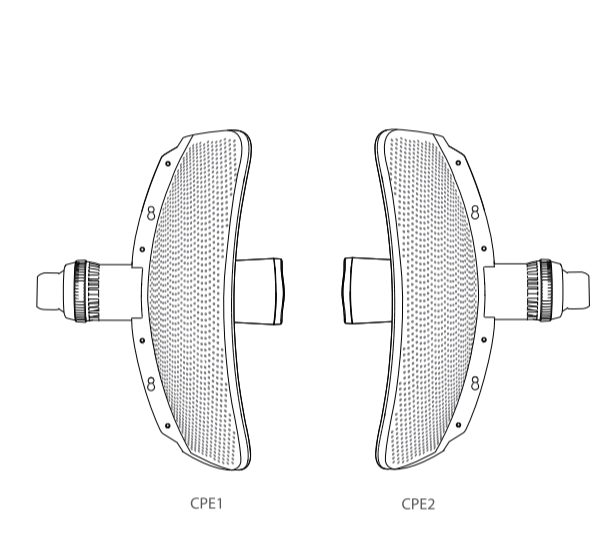

Step2: Power on CPE1 and connect it to a computer.
Use the included PoE adapter to power on the CPE1. The PoE/LAN LED indicator of CPE1 lights up.
Use an Ethernet cable to connect the LAN port of the PoE adapter to a computer.

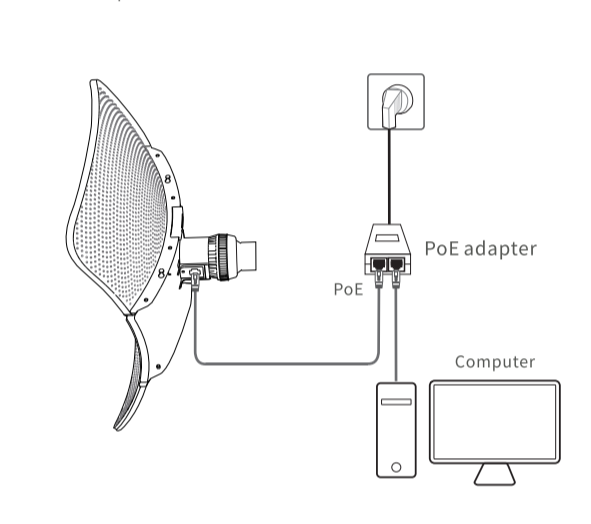

Step3: Set CPE1 to AP mode.
Start a web browser on the computer and visit 192.168.2.1. Enter the login user name and password and click Login.

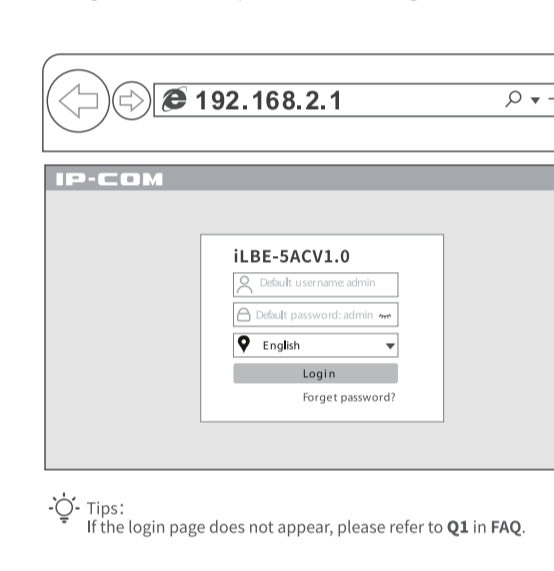

Select AP, and click Next.

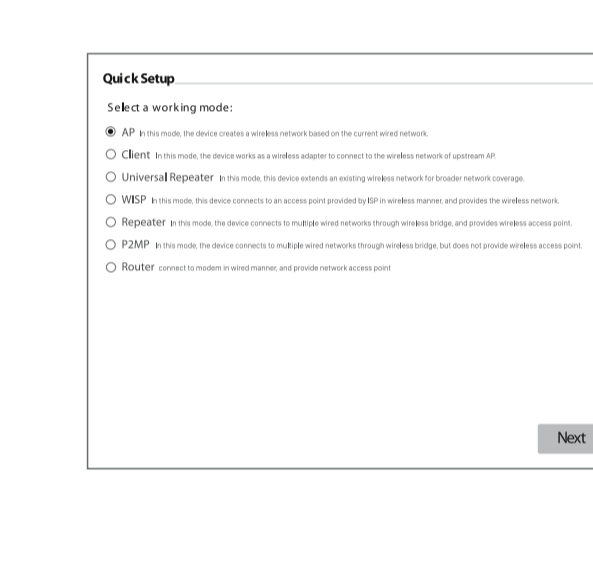

Customize your SSID (WiFi name) and Key (WiFi password), select a Channel, a Security Mode (WPA2-PSK is recommended), and an Encryption Algorithm. Click Next.
Record the SSID and Key for later setup.

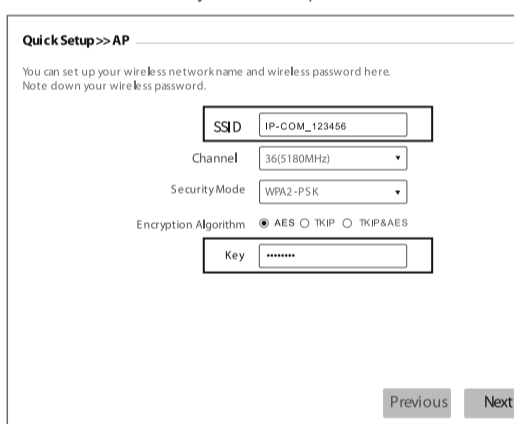

Click Save, and wait until the CPE reboots automatically to activate the settings.

Step4: Set CPE2 to Client mode.
Perform Step 2 to power on the CPE2 and connect it to a computer.
Start a web browser on the computer and visit 192.168.2.1. Enter the login user name and password and click Login.

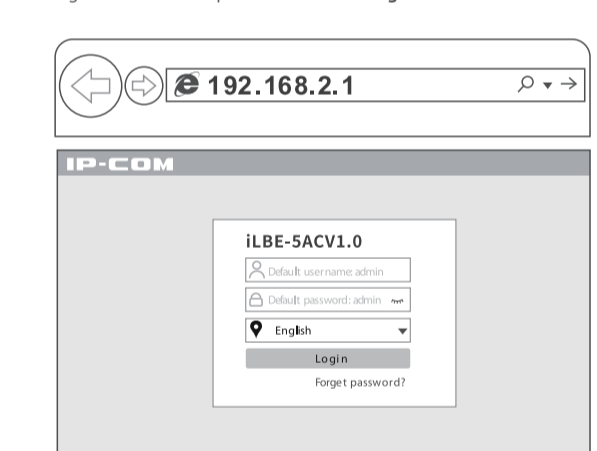

Tips: If the login page does not appear, please refer to Q1 in FAQ.

Select Client, and click Next.

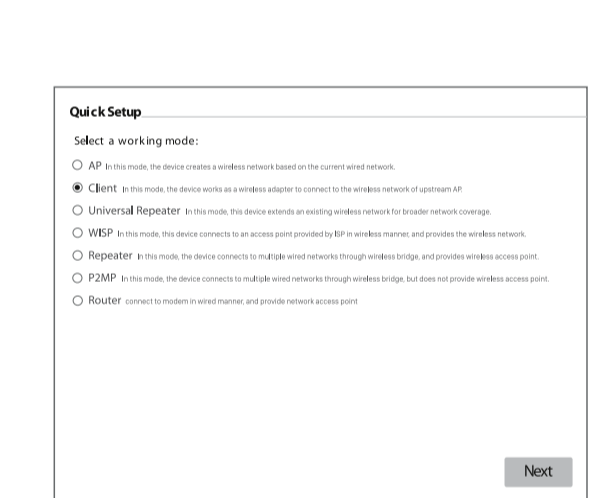

Select the SSID of CPE1, which is IP-COM_123456 in this example, and click Next.

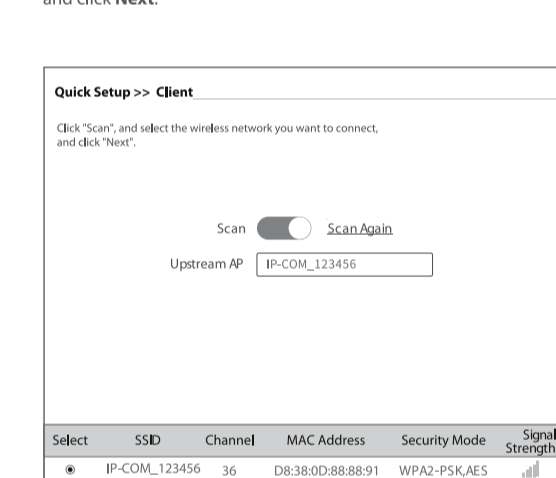

Enter the Key of CPE1, and click Next.

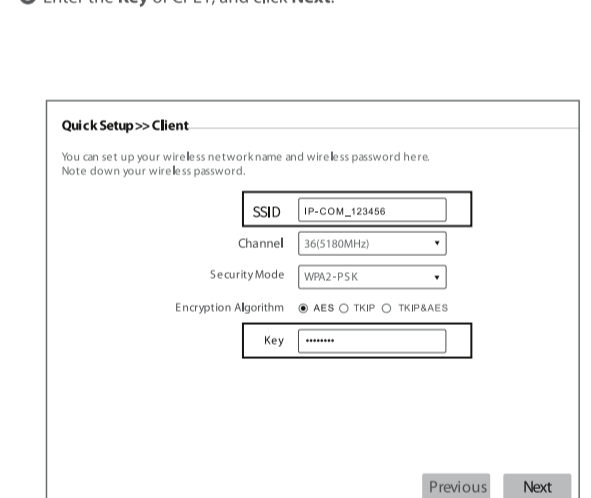

Set the IP address to an unused one belonging to the same network segment as that of CPE1. For example, if the IP address of CPE1 is 192.168.2.1, you can set this device's IP address to 192.168.2.X (X ranges from 2 to 254). Then click Next.

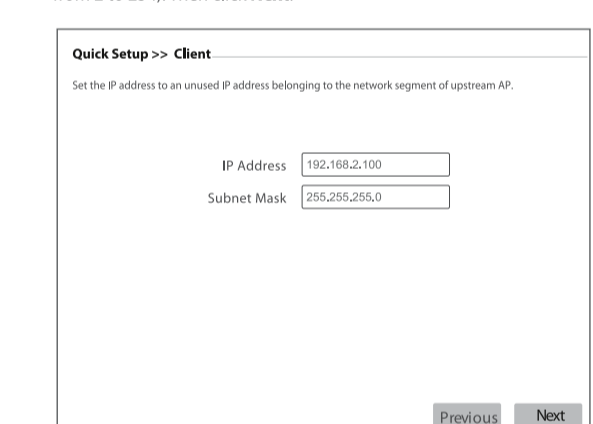

Click Save, and wait until the CPE reboots to activate the settings.
When the LED1, LED2 and LED3 indicators of CPE1 light solid on, and the LED1, LED2 and LED3 indicators of CPE2 blink, the bridging succeeds and the DHCP servers of the two CPEs are disabled automatically.

Scenario 2: Wireless ISP hotspot access

1. Set up the CPE

Step1: Power on the CPE and connect it to a computer.
Use an Ethernet cable to connect the PoE/LAN port of the CPE to the PoE port of the PoE adapter.
Use the included power cord to connect the PoE adapter to a power source.
Connect a computer to the LAN port of the PoE adapter.

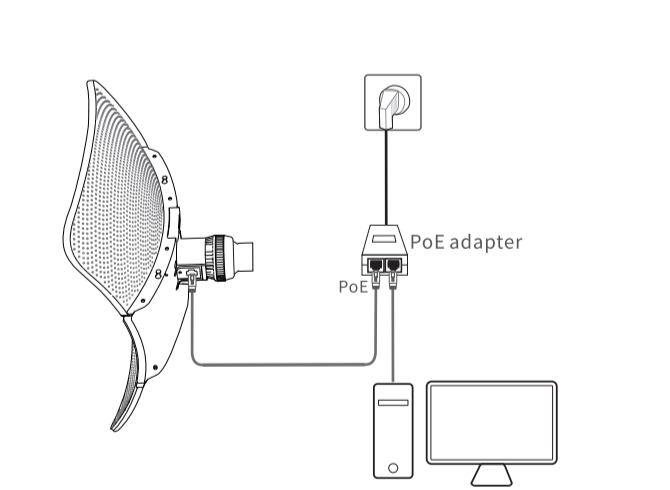

Step2: Set the CPE to WISP mode.
Start a web browser on the computer and visit 192.168.2.1. Enter your user name and password and click Login.

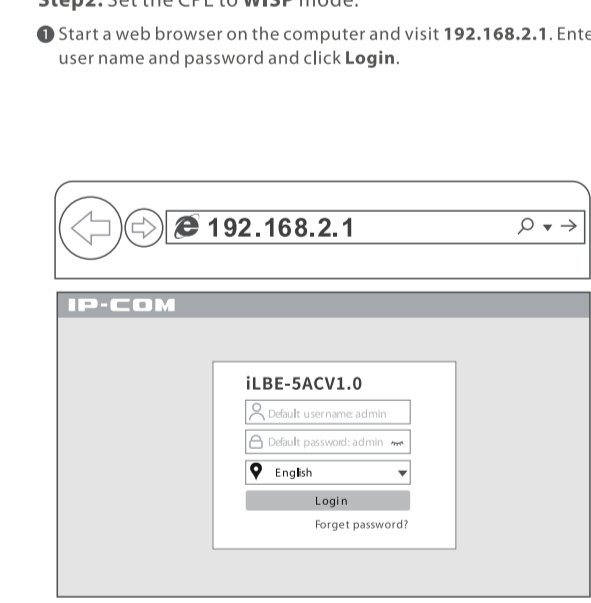

Select WISP, and click Next.



Select the SSID of the ISP (Internet Service Provider) hotspot, which is IP-COM_123456 in this example, and click Next.

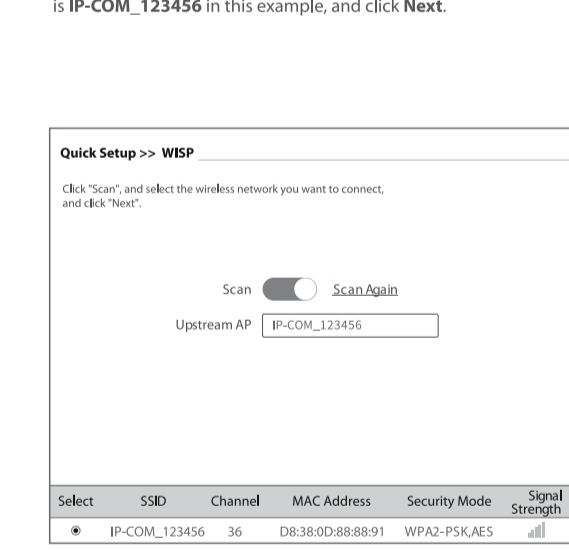

Enter the password for the ISP hotspot in the Key box, and click Next.

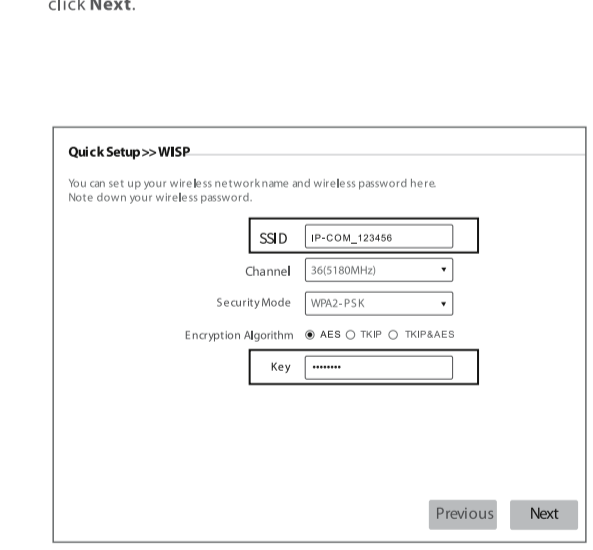

2. Application scenario

Connect the CPEs with the LED1, LED2 and LED3 indicators solid on (AP mode—the transmitting end) to the switch which is connected to a NVR (Network Video Recorder).
Connect the CPEs with the LED1, LED2 and LED3 indicators blinking (Client mode—the receiving end) to IP camera or a switch which is connected to IP cameras.
After successful installation, the connection quality reaches the best when the LED1, LED2 and LED3 indicators of the CPEs light solid on or blink.

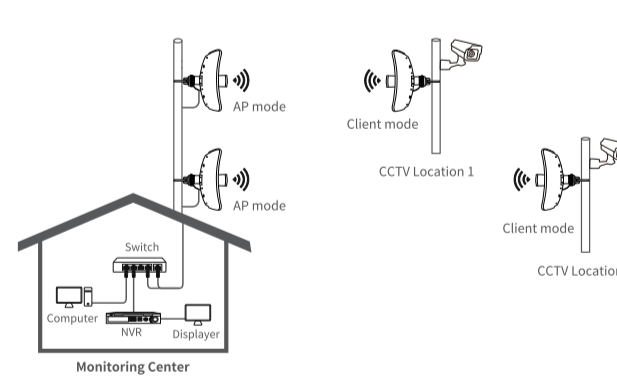

Select the Internet Connection Type of your ISP hotspot.
PPPoE is used for illustration here. Enter the PPPoE user name and password provided by your ISP, and click Next.

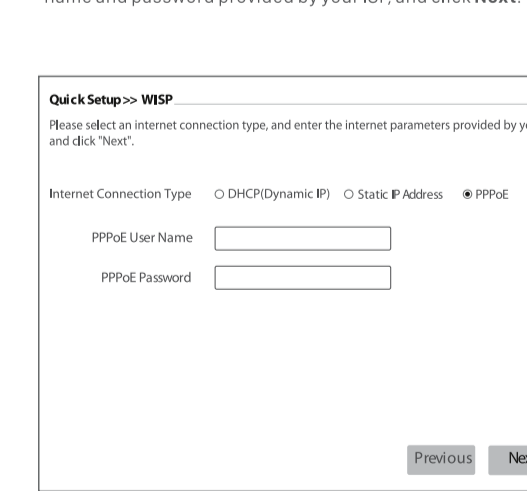

Customize the SSID (WiFi Name), select a security mode (WPA2-PSK is recommended), customize a Key, and click Next.

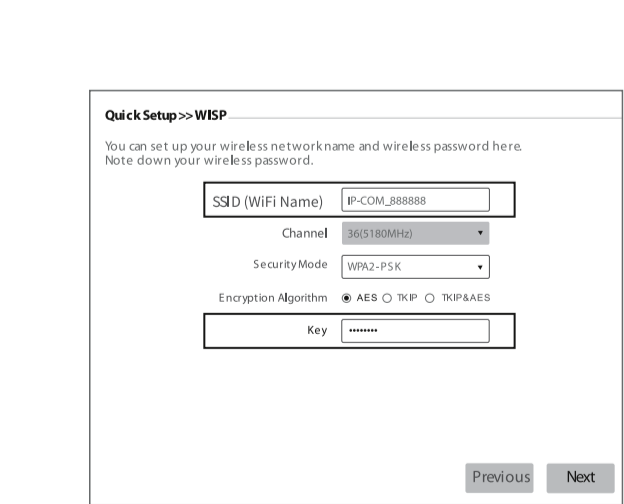

Set an IP address belonging to different network segment as that of your ISP hotspot. For example, if the IP address of your ISP hotspot is 192.168.2.1, you can set this CPE's IP address to 192.168.X.Y (X ranges from 0 to 254 excluding 2). Then click Next.

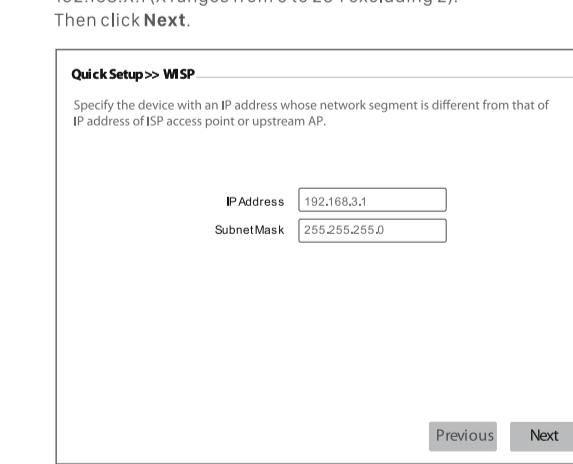

Click Save, and wait until the CPE reboots to activate the settings.

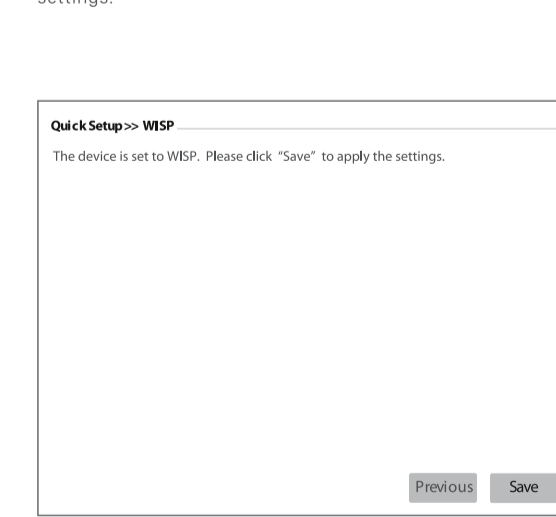

2. Application scenario

Place the CPE over the roof.
Connect the LAN port of the PoE adapter to the WAN port of your wireless router. The connection quality reaches the best when the LED1, LED2 and LED3 indicators of the CPE blink.

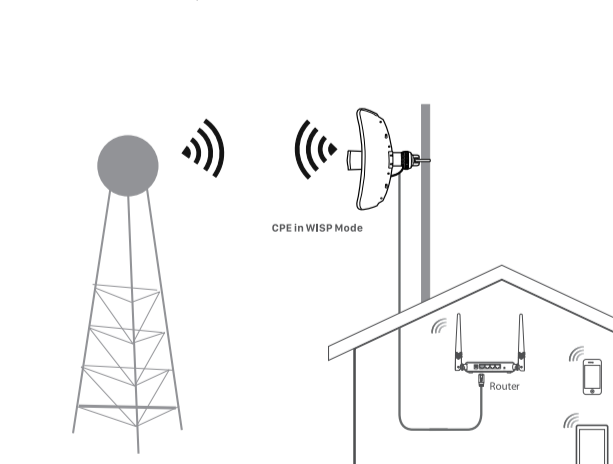

CE

CE Mark Warning
This is a Class A product. In a domestic environment, this product may cause radio interference, in which case the user may be required to take adequate measures.
NOTE: (1) The manufacturer is not responsible for any radio or TV interference caused by this equipment. (2) To avoid unnecessary radiation interference, it is recommended to use a shielded RJ45 cable.
Declaration of Conformity
Herby, SHENZHEN IP-COM Networks Co., Ltd. declares that the radio equipment type ILBE-5AC is in compliance with Directive 2014/53/EU.
The full text of the EU declaration of conformity is available at the following internet address: http://ip-com.com.cn/en/ce.html
Operating Frequency Range: EU/S150-S250MHz (CH35-CH48); ERP Power (Max.): 22.98 dBm
Operating Frequency Range: EU/S470-S725MHz (CH100-CH116, CH13-CH140); ERP Power (Max.): 26.98 dBm
Software Version: V1.0.0.10
For EU/EFTA, this product can be used in the following countries:



Appendix FAQ

Q1: I cannot log in to the web UI of the CPE by entering 192.168.2.1. What should I do?
A1: Try the following solutions:
- Ensure that the CPE is connected to a power source and your computer properly.
- Ensure that the IP address of the computer is set to an unused one, such as 192.168.2.X (X ranges from 2-254).
- Restore the CPE to factory settings, and try again.

Q2: How to check that the CPE is under the best connection status?
A2: Try the following methods:
Method 1: Observe the LED indicators of the CPE. The connection quality reaches the best when the LED1, LED2 and LED3 indicators of the CPEs light solid on or blink.
Method 2: Log in to the web UI of one CPE (the default IP address is 192.168.2.1), check the bridging status in Status > Wireless Status.
Stronger signal strength (<60 dBm is better than >70 dBm) and less background noise (<100 dBm is better than >90 dBm) lead to better bridging signal.

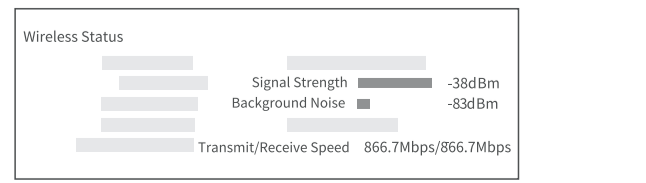

Q3: After the bridging succeeds, the LED1, LED2 and LED3 indicators do not light up or only some of them do. What should I do?
A3: Try the following solutions:
- Ensure that the bridging distance between the CPEs is within the normal range.
- Place the CPEs in an elevated location at the same height with few obstacles nearby.
- Make slight direction adjustment of the CPEs by moving it vertically and horizontally. Change the direction with an interval of 20-30° each time in order to observe the change of LED1, LED2 and LED3 indicators until the best signal is received.

RECYCLING
This product bears the selective sorting symbol for Waste electrical and electronic equipment (WEEE). This means that this product must be handled pursuant to European directive 2012/19/EU in order to be recycled or dismantled to minimize its impact on the environment.
User has the choice to give his product to a competent recycling organization or to the retailer when he buys a new electrical or electronic equipment.

Operating Environment
Operating Temperature: -30°C ~ 60°C
Operating Humidity: 10% ~ 90% RH, non-condensing

Caution:
Adapter Model: BN060-P12024
Manufacture: SHENZHEN HEWEISHUN NETWORK TECHNOLOGY CO., LTD.
Input: 100-240V ~ 50/60Hz 0.3A
Output: 24V ~ 0.5A
DC Voltage

FCC

FCC Statement
This equipment has been tested and found to comply with the limits for a Class A digital device, pursuant to Part 15 of the FCC Rules. These limits are designed to provide reasonable protection against harmful interference in a residential installation. This equipment generates, uses and can radiate radio frequency energy and, if not installed and used in accordance with the instructions, may cause harmful interference to radio communications. However, there is no guarantee that interference will not occur in a particular installation. If this equipment does cause harmful interference to radio or television reception, which can be determined by turning the equipment off and on, the user is encouraged to try to correct the interference by one or more of the following measures:
-Reorient or relocate the receiving antenna.
-Increase the separation between the equipment and receiver.
-Connect the equipment into an outlet on a circuit different from that to which the receiver is connected.
-Consult the dealer or an experienced radio/TV technician for help.
Operation is subject to the following two conditions: (1) this device may not cause harmful interference, and (2) this device must accept any interference received, including interference that may cause undesired operation.

Radiation Exposure Statement
This device complies with FCC radiation exposure limits set forth for an uncontrolled environment and it also complies with Part 15 of the FCC Rules. This equipment should be installed and operated with minimum distance 20cm between the device and your body.

Caution:
Any changes or modifications not expressly approved by the party responsible for compliance could void the user's authority to operate this equipment.
This transmitter must not be co-located or operating in conjunction with any other antenna or transmitter.
NOTE: (1) The manufacturer is not responsible for any radio or TV interference caused by unauthorized modifications to this equipment. (2) To avoid unnecessary radiation interference, it is recommended to use a shielded RJ45 cable.

Technical Support
Address: Room 101, Unit A, First Floor, Tower E3, NO.1001, Zhongshanyuan Road, Nanshan District, Shenzhen, China, 518052
Tel: (86)755 2765 3089
Email: info@ip-com.com.cn
Website: www.ip-com.com.cn

Copyright
© 2020 IP-COM Networks Co., Ltd. All rights reserved.
This documentation (including diagrams, images, and product specifications, etc.) is for reference only. To improve internal design, operational function, and/or reliability, IP-COM reserves the right to make changes to the products described in this document without obligation to notify any person or organization of such revisions or changes.