

Road Traffic Management



DATASHEET



INTRODUCTION

Milesight Road Traffic Management Camera combines video surveillance with AI, ANPR, 3D Radar and other cutting-edge technologies helps traffic management agencies systematically and intelligently monitor and understand road users' behavior and gain valuable insights based on real-time data to optimize traffic flow, minimize accident risks, and respond to emergencies more efficiently. It can be widely used in urban public security management systems, which can significantly improve management efficiency and make traffic smarter, safer and smoother.



AI Road Traffic Pro Bullet Plus Camera

- 4X Optical Zoom
- 1/2" STARVIS Starlight Sensor
- 100fps
- 3 in 1 Super WDR Pro - 140dB
- Up to 70m Illumination Distance
- Smart IR II Technology
- IP67 & IK10
- Versatile Interfaces
- Integrated Cable Management



AI Road Traffic Radar Pro Bullet Plus Camera

- Advanced 3D Radar Technology
- 4X Optical Zoom
- 1/2" STARVIS Starlight Sensor
- 100fps
- 3 in 1 Super WDR Pro - 140dB
- Up to 70m Illumination Distance
- Smart IR II Technology
- IP67
- Versatile Interfaces
- Easy Deployment and Compact Structure
- Integrated Cable Management



AI Road Traffic Supplement Light Pro Bullet Plus Camera

- Integrated Supplement Light
- Wiegand Protocol Supported
- 4X Optical Zoom
- 1/2" STARVIS Starlight Sensor
- 100fps
- 3 in 1 Super WDR Pro - 140dB
- Up to 70m Illumination Distance
- Smart IR II Technology
- IP67
- Versatile Interfaces



AI Road Traffic 5G Pro Bullet Plus Camera

- 5G Technology
- 4X Optical Zoom
- 1/2" STARVIS Starlight Sensor
- 100fps
- 3 in 1 Super WDR Pro - 140dB
- Up to 70m Illumination Distance
- Smart IR II Technology
- IP67
- Versatile Interfaces
- Easy Deployment and Compact Structure



AI Road Traffic PTZ Bullet Camera

- Flexible Pan, Tilt and Zoom Tasks
- 12X Optical Zoom
- 1/2.8" STARVIS Starlight Sensor
- 100fps
- 3 in 1 Super WDR Pro - 140dB
- Up to 175m Illumination Distance
- Smart IR II Technology
- Intelligent White LED
- Smart PTZ Motion Detection
- IP66
- Keyboard Control



AI Road Traffic PTZ Bullet Plus Camera

- New-generation PTZ Motor
- Flexible Pan, Tilt and Zoom Tasks
- 5X Optical Zoom
- 1/2" STARVIS Starlight Sensor
- 100fps
- 3 in 1 Super WDR Pro - 140dB
- Up to 110m Illumination Distance
- Smart IR II Technology
- Intelligent White LED
- Smart PTZ Motion Detection
- IP66
- Keyboard Control



AI Road Traffic Speed Dome Camera

- Smart Rain-Sensing Wiper (Optional)
- 36X Optical Zoom
- 1/2" STARVIS Starlight Sensor
- 100fps
- 3 in 1 Super WDR Pro - 140dB
- Up to 290m Illumination Distance
- Smart IR II Technology
- Smart PTZ Motion Detection
- IP66
- Keyboard Control
- Versatile Interfaces
- Exquisite Design



AI Road Traffic Parking Detection Pro Bullet Plus Camera

- Parking Detection
- Parking Violation Detection
- Motorized Zoom Lens
- 1/1.8" STARVIS Starlight Sensor
- 120dB Super WDR
- Smart IR II Technology
- IP67 & IK10
- Versatile Interfaces
- Integrated Cable Management Bracket

Road Traffic Management



Application of Milesight Traffic Solution

Advanced AI LPR Algorithm Improves Road Safety

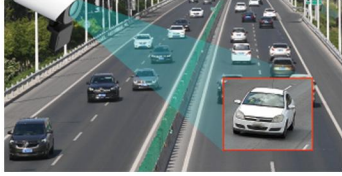

No-plate Vehicle Capture

- Real-time Detection of Vehicles without License Plates.
- Capture Snapshot & Smart Search.



Specific Lane Management

- Detection of Cars and Trucks Traveling or Parking in Bus Lanes.
- Customize Permitted Vehicles & Residence Time.



Parking Violation Detection

- Real-time Capture of Violated Vehicles that Exceed the Set Time.
- Smart Parking Search.

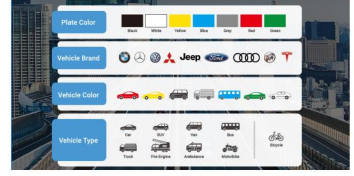

Vehicle Attributes Alarm based on Schedule

- Various Vehicle Attributes Recognition to Search & Locate Target Vehicles Faster.
- Avoid Illegal Vehicles on the Road.
- Locate Stolen & Abnormal Vehicles.



Speeding Detection (Only for Radar Models)



Reverse Driving Detection

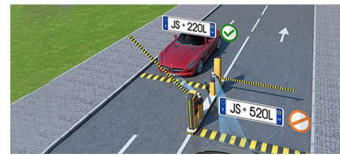

Black/White List Management

Ideal for Traffic Flow Statistics and Analysis



Vehicle Counting Based on Vehicle Type

- Car/Motorcycle/Non-motor
- Small/Medium/Large Vehicle
- Various Vehicle Attributes.

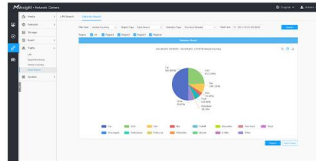

Intuitive Report

- The Vehicle Counting Results are Visually Displayed in The Live View Interface.
- Multiple Report Types including Line Chart and Pie Chart.

Evidence Capture Improves Enforcement Efficiency



Evidence Camera Linkage

- Linking LPR Camera and Regular Camera for Evidence Capture
- LPR Camera for License Plate Recognition and Linkage Triggering
- Regular Camera for Full Snapshot of the Scene



LPR Smart Search Function

- Real-time detection results
- Detected time, live screenshot, license plate
- Search by Plate Color, Vehicle Type & Color, Speed, Direction, etc.
- Manual Export & Auto Export

Intelligent Plate Data Management Helps Enhance City Management



Black/White List Management

- Add the license plates & Batch Upload.
- Black List/White List/Visitor Mode.
- List Scheduling Management.
- Set the alarm action for the plates.



Stand alone LPR Solution

- Built-in AI LPR Algorithm.
- Embedded Black & White Lists.



Closed-loop Back-end Integration

- Full Compatibility with Milesight Back-ends.
- Completely Closed-loop ANPR Solutions.



Open Integration with 3rd Party

- Various CGI/APIs.
- Diverse Protocols Available to Reduce Extra Human Labour (Wiegand, TCP, HTTP, etc. .)
- Full Data Push.

License Plates Administration Backed by Intelligence

Improve Road Safety and Enforcement Efficiency



Embedded AI LPR Algorithm



AI-based Vehicle Attributes Recognition

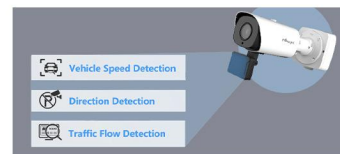

Integrated 3D Radar Technology

- Vehicle Speed Detection
- Direction Detection
- Traffic Flow Detection



Broad Range of Countries and Regions Supported

Road Traffic Management



Superior Image Quality for 24/7 Traffic Monitoring

Excellent Capture Performance

- Stunning Image Performance Even in the Night



• LPR Image Mode



• Integrated Supplement Light



HLC Off



HLC On

• HLC (Highlight Compensation)



By Conventional Camera



By Milesight Camera

• 0.002Lux Starlight

- Accurately Capture Plates of Fast Moving Vehicles



Dynamic Clarity Off



Dynamic Clarity On



30fps@1080P



100fps@1080P

- Excellent Capture Performance at High Speed and Accuracy

200km/h

Recognizable Speed

>95%

High Recognition Accuracy



License Plate
Serial Format

4

Detection
Regions

Maximized Flexibility for Your Convenience

Unique Design, Easy and Flexible Installation



- Integrated Junction Box



- 3-Axis Mechanical Design

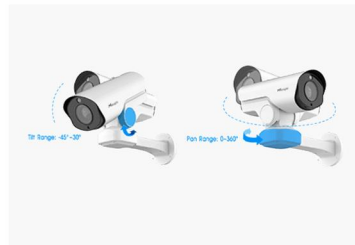

- Flexible Pan, Tilt and Zoom Tasks for ANPR





- Easy Deployment and Compact Structure



OBTAIN
THE USER MANUAL





	Name	AI Road Traffic Pro Bullet Plus Camera	AI Road Traffic Radar Pro Bullet Plus Camera
Camera	Appearance		
	Model	TS2866-X4TPC (2MP)	TS2866-X4TVPC (2MP)
	Image Sensor	1/2" Progressive Scan CMOS	
	Min. Illumination	Color: 0.002Lux@F1.6 B/W: 0Lux with IR on	
	WDR	140dB Super WDR Pro	
	Shutter Time	1/100000s~1s	
	Day/Night Mode	Day/Night/Auto/Customize/Schedule	
	S/N	>55dB	
Lens	Lens	8~32mm, 4X Optical Zoom	
	Field of View	H44°~H13°/D51°~D15°/V25°~V7°	
	Mount	Φ14	
	Focus Control	Auto/Manual	
	Aperture	F1.6~F1.7	
	Iris Control	Auto	
Road Traffic Management	Max. Vehicle Speed	200km/h	
	Recognition Accuracy	>95%	
	Coverage	Support simultaneous detection of 4 regions	
	Country Region Supported	More than 80 countries and regions	
	Illumination Distance	Up to 70m during the day; Up to 35m during the night with illumination	
	Attributes Identification	Plate Color, Vehicle Type, Vehicle Color, Vehicle Brand, No-plate Vehicle Capture	Plate Color, Vehicle Type, Vehicle Color, Vehicle Brand, No-plate Vehicle Capture, Vehicle Direction Detection, Speed Detection, Traffic Flow Detection
	Smart Traffic Function	Evidence Camera Linkage, Vehicle Counting Based on Vehicle Type, Specific Lane Management	
	White/Black List	Up to 1000 records inside the camera	
LPR Smart Search	Support		
Radar	Working Frequency	-	60GHz, 61~62GHz
	Capture Rate	-	>99% (Traffic jam >95%)
	Lane Coverage	-	1~4 Lanes (Recognition ≥95% individually)
	Tracking Target	-	Up to 32
	Speed Detection Range	-	±5km/h~±200km/h
	Speed Detection Accuracy	-	±0.36km/h
	Detection Distance	-	Up to 90m
	Distance Detection Accuracy	-	±0.4m
	Angle Measurement Accuracy	-	±0.5°
	Installation Height	-	2~7m

Road Traffic Management



Interface	Ethernet	1*RJ45 10M/100M Ethernet Port
	Audio I/O	1/1
	Alarm I/O	1/1
Video	Max. Image Resolution	1920x1080
	Primary Stream	60Hz/50Hz: 100fps@(1920x1080, 1280x960, 1280x720, 704x576)
	Secondary Stream	60Hz: 60fps@(704x576, 640x480, 640x360, 352x288, 320x240, 320x192, 320x180) 50Hz: 50fps@(704x576, 640x480, 640x360, 352x288, 320x240, 320x192, 320x180)
	Tertiary Stream	60Hz: 30fps@(1920x1080, 1280x720, 704x576, 640x480, 640x360, 320x240, 320x192, 320x180) 50Hz: 25fps@(1920x1080, 1280x720, 704x576, 640x480, 640x360, 320x240, 320x192, 320x180)
	Video Compression	H.265+/H.265(HEVC)/H.264+/H.264/MJPEG
	Video Bit Rate	16Kbps~16Mbps(CBR/VBR Adjustable)
	Privacy Masking	Up to 28 areas(24 mask areas and 4 mosaic areas)
	ROI	Up to 8 areas
	Image Setting	Brightness/Contrast/Saturation/Sharpness
Network	Network Storage	NAS(Support NFS, SMB/CIFS), ANR
	Protocol	IPv4/IPv6, ARP, TCP, UDP, RTCP, RTP, RTSP, RTMP, HTTP, HTTPS, DNS, DDNS, DHCP, FTP, NTP, SMTP, SNMP, UPnP, Bonjour, SIP, PPPoE, VLAN, 802.1x, QoS, IGMP, ICMP, SSL
Audio	Audio Compression	G.711/AAC/G.722/G.726
	Audio Sampling Rate	8/16/32/44.1/48KHz
	Audio Bit Rate	16~256kbps
	Two-way Audio	Support
System	System Compatibility	API, HTTP, TCP, ONVIF Profile G & Q & S & T
	Storage	Support microSD/SDHC/SDXC Card Local Storage, up to 256G
	Advanced Function	BLC, HLC, 2D DNR, 3D DNR, Defog, AWB, EIS, IP Address Filtering, AGC, Anti-flicker, Corridor Mode, Deblur, Watermark
	SIP/VoIP Support	Yes, Voice & Video-over-IP
	Event Trigger	Black/White List, Attributes Event, Motion Detection, Network Disconnection, External Input, Audio Alarm, etc.
	Event Action	FTP Upload, SMTP Upload, SD Card Record, External Output, SIP Phone, HTTP Notification, etc
General	Working Temperature	-40°C~60°C
	Working Humidity	0~95%(Non-condensing) 5~90%(Non-condensing)
	Power Supply	PoE (802.3at) / DC 12V±10%
	Power Consumption	8W MAX 14W MAX (With IR on)
	Weather Proof	Up to IP67-rated for Weather-resistant Performance
	Housing	Vandal-proof IK10-rated Metal Housing Vandal-proof IK10-rated Metal Housing (Without Radar Module)
	Surge Protection	4KV
	Weight	1445.8g 1623g
	Dimensions	320mmX134mmX126mm 320mmX134mmX171mm
	Warranty	3/5 Years



Name		AI Road Traffic Supplement Light Pro Bullet Plus Camera	
Camera	Appearance		
	Model	TS2866-X4TWC /W (2MP)	TS2866-X4TWC /R (2MP)
	Image Sensor	1/2" Progressive Scan CMOS	
	Min. Illumination	Color: 0.002Lux@F1.6 B/W: 0Lux with IR on	
	WDR	140dB Super WDR Pro	
	Shutter Time	1/100000s~1s	
	Day/Night Mode	Day/Night/Auto/Customize/Schedule	
	S/N	>55dB	
Lens	Lens	8~32mm, 4X Optical Zoom	
	Field of View	H44°~H13°/D51°~D15°/V25°~V7°	
	Mount	Φ14	
	Focus Control	Auto/Manual	
	Aperture	F1.6-F1.7	
	Iris Control	Auto	
Road Traffic Management	Max. Vehicle Speed	200km/h	
	Recognition Accuracy	>95%	
	Coverage	Support simultaneous detection of 4 regions	
	Country Region Supported	More than 80 countries and regions	
	Illumination Distance	Up to 70m during the day; Up to 45m during the night with illumination	
	Attributes Identification	Plate Color, Vehicle Type, Vehicle Color, Vehicle Brand, No-plate Vehicle Capture	
	Smart Traffic Function	Evidence Camera Linkage, Vehicle Counting Based on Vehicle Type, Specific Lane Management	
	White/Black List	Up to 1000 records inside the camera	
	LPR Smart Search	Support	
Illuminator	Supplement Light	White LED Light	IR LED Light
	Light Bead	6 (For White LED Light)	9 (For IR LED Light)
	Light Control	Auto/Always On/Off/Customize	
Interface	Ethernet	1*RJ45 10M/100M Ethernet Port	
	Audio I/O	1/1	
	Alarm I/O	1/1	
	Wiegand	Standard Wiegand 26-bit	



Video	Max. Image Resolution	1920x1080	
	Primary Stream	60Hz/50Hz: 100fps@(1920x1080, 1280x960, 1280x720, 704x576)	
	Secondary Stream	60Hz: 60fps@(704x576, 640x480, 640x360, 352x288, 320x240, 320x192, 320x180) 50Hz: 50fps@(704x576, 640x480, 640x360, 352x288, 320x240, 320x192, 320x180)	
	Tertiary Stream	60Hz: 30fps@(1920x1080, 1280x720, 704x576, 640x480, 640x360, 320x240, 320x192, 320x180) 50Hz: 25fps@(1920x1080, 1280x720, 704x576, 640x480, 640x360, 320x240, 320x192, 320x180)	
	Video Compression	H.265+/H.265(HEVC)/H.264+/H.264/MJPEG	
	Video Bit Rate	16Kbps~16Mbps(CBR/VBR Adjustable)	
	Privacy Masking	Up to 28 areas(24 mask areas and 4 mosaic areas)	
	ROI	Up to 8 areas	
	Image Setting	Brightness/Contrast/Saturation/Sharpness	
Network	Network Storage	NAS(Support NFS, SMB/CIFS), ANR	
	Protocol	IPv4/IPv6, ARP, TCP, UDP, RTCP, RTP, RTSP, RTMP, HTTP, HTTPS, DNS, DDNS, DHCP, FTP, NTP, SMTP, SNMP, UPnP, Bonjour, SIP, PPPoE, VLAN, 802.1x, QoS, IGMP, ICMP, SSL	
Audio	Audio Compression	G.711/AAC/G.722/G.726	
	Audio Sampling Rate	8/16/32/44.1/48KHz	
	Audio Bit Rate	16~256kbps	
	Two-way Audio	Support	
System	System Compatibility	API, HTTP, TCP, Wiegand Protocol, ONVIF Profile G & Q & S & T	
	Storage	Support microSD/SDHC/SDXC Card Local Storage, up to 256G	
	Advanced Function	BLC, HLC, 2D DNR, 3D DNR, Defog, AWB, EIS, IP Address Filtering, AGC, Anti-flicker, Corridor Mode, Deblur, Watermark	
	SIP/VoIP Support	Yes, Voice & Video-over-IP	
	Event Trigger	Black/White List, Attributes Event, Motion Detection, Network Disconnection, External Input, Audio Alarm, etc.	
	Event Action	FTP Upload, SMTP Upload, SD Card Record, External Output, SIP Phone, HTTP Notification, etc	
General	Working Temperature	-40°C~60°C	
	Working Humidity	5~90%(Non-condensing)	
	Power Supply	DC 12V / 3A±10% (Non-PoE)	
	Power Consumption	4W MAX 30W MAX (For White LED Light)	4W MAX 31W MAX (For IR LED Light)
	Surge Protection	4KV	
	Weather Proof	Up to IP67-rated for Weather-resistant Performance	
	Housing	Vandal-proof IK10-rated Metal Housing (Without Supplement Light)	
	Surge Protection	4KV	
	Weight	1445.8g 2100g (With Supplement Light)	
	Dimensions	282mmX108mmX120mm 282mmX108mmX225mm (With Supplement Light)	
	Warranty	3/5 Years	





Camera	Name	AI Road Traffic 5G Pro Bullet Plus Camera	
	Appearance		
	Model	TS2866-X4TGPC (2MP)	
	Image Sensor	1/2" Progressive Scan CMOS	
	Min. Illumination	Color: 0.002Lux@F1.6 B/W: 0Lux with IR on	
	WDR	140dB Super WDR Pro	
	Shutter Time	1/100000s~1s	
	Day/Night Mode	Day/Night/Auto/Customize/Schedule	
S/N	>55dB		
Lens	Lens	8~32mm, 4X Optical Zoom	
	Field of View	H44°~H13°/D51°~D15°/V25°~V7°	
	Mount	Φ14	
	Focus Control	Auto/Manual	
	Aperture	F1.6~F1.7	
	Iris Control	Auto	
Road Traffic Management	Max. Vehicle Speed	200km/h	
	Recognition Accuracy	>95%	
	Coverage	Support simultaneous detection of 4 regions	
	Country Region Supported	More than 80 countries and regions	
	Illumination Distance	Up to 70m during the day; Up to 35m during the night with illumination	
	Attributes Identification	Plate Color, Vehicle Type, Vehicle Color, Vehicle Brand, No-plate Vehicle Capture	
	Smart Traffic Function	Evidence Camera Linkage, Vehicle Counting Based on Vehicle Type, Specific Lane Management	
	White/Black List	Up to 1000 records inside the camera	
LPR Smart Search	Support		
Interface	Ethernet	1*RJ45 10M/100M Ethernet Port	
	Audio I/O	1/1	
	Alarm I/O	1/1	
Mobile Communication Parameter	Wireless Communication	Support 5G/4G/3G	
	Frequency Bands	5G NR	n1/n2/n3/n5/n7/n8/n12/n20/n28/n41/n66/n71/n77/n78/n79
		LTE-FDD	B1/B2/B3/B4/B5/B7/B8/B9/B12/B13/B14/B17/B18/B19/B20/B21(TBD)/ B25/B26/B28/B29/B30/B32/B66/B71
		LTE-TDD	B34/B38/39/B40/B41/B42/B48
		LAA	B46
WCDMA	B1/B2/B3/B4/B5/B6/B8/B19		

Road Traffic Management



Mobile Communication Parameter	Wireless Transmission Speed	SA NSA LTE WCDMA	DL 3.3Gbps; UL 250Mbps DL 3.4Gbps; UL 200Mbps DL 2.0Gbps; UL 150Mbps DL 42Mbps; UL 5.76Mbps
	SIM Card		Nano SIM
Video	Max. Image Resolution		1920x1080
	Primary Stream		60Hz/50Hz: 100fps@(1920x1080, 1280x960, 1280x720, 704x576)
	Secondary Stream		60Hz: 60fps@(704x576, 640x480, 640x360, 352x288, 320x240, 320x192, 320x180) 50Hz: 50fps@(704x576, 640x480, 640x360, 352x288, 320x240, 320x192, 320x180)
	Tertiary Stream		60Hz: 30fps@(1920x1080, 1280x720, 704x576, 640x480, 640x360, 320x240, 320x192, 320x180) 50Hz: 25fps@(1920x1080, 1280x720, 704x576, 640x480, 640x360, 320x240, 320x192, 320x180)
	Video Compression		H.265*/H.265(HEVC)/H.264*/H.264/MJPEG
	Video Bit Rate		16Kbps~16Mbps(CBR/VBR Adjustable)
	Privacy Masking		Up to 28 areas(24 mask areas and 4 mosaic areas)
	ROI		Up to 8 areas
	Image Setting		Brightness/Contrast/Saturation/Sharpness
Network	Network Storage Protocol		NAS(Support NFS, SMB/CIFS), ANR IPv4/IPv6, ARP, TCP, UDP, RTCP, RTP, RTSP, RTMP, HTTP, HTTPS, DNS, DDNS, DHCP, FTP, NTP, SMTP, SNMP, UPnP, Bonjour, SIP, PPPoE, VLAN, 802.1x, QoS, IGMP, ICMP, SSL
Audio	Audio Compression		G.711/AAC/G.722/G.726
	Audio Sampling Rate		8/16/32/44.1/48KHz
	Audio Bit Rate		16~256kbps
	Two-way Audio		Support
System	System Compatibility		API, HTTP, TCP, ONVIF Profile G & Q & S & T
	Storage		Support microSD/SDHC/SDXC Card Local Storage, up to 256G
	Advanced Function		BLC, HLC, 2D DNR, 3D DNR, Defog, AWB, EIS, IP Address Filtering, AGC, Anti-flicker, Corridor Mode, Deblur, Watermark
	SIP/VoIP Support		Yes, Voice & Video-over-IP
	Event Trigger		Black/White List, Attributes Event, Motion Detection, Network Disconnection, External Input, Audio Alarm, etc.
	Event Action		FTP Upload, SMTP Upload, SD Card Record, External Output, SIP Phone, HTTP Notification, etc
General	Working Temperature		-40°C~60°C
	Working Humidity		0~95%(Non-condensing)
	Power Supply		PoE (802.3at) / DC 12V±10%
	Power Consumption		8W MAX 14W MAX (With IR on)
	Surge Protection		4KV
	Weather Proof		Up to IP67-rated for Weather-resistant Performance (Only for camera body)
	Weight		1608g
	Dimensions		320mmX134mmX126mm 320mmX134mmX292mm (With 5G Antennas)
	Warranty		3/5 Years





	Name	AI Road Traffic PTZ Bullet Camera	AI Road Traffic PTZ Bullet Plus Camera
Camera	Appearance		
	Model	TS2961-X12TPC (2MP)	TS2867-X5TPC (2MP)
	Image Sensor	1/2.8" Progressive Scan CMOS	1/2" Progressive Scan CMOS
	Min. Illumination	Color: 0.005Lux@F1.6 B/W: 0Lux with IR on	Color: 0.002Lux@F1.7 B/W: 0Lux with IR on
	WDR	140dB Super WDR Pro	
	Shutter Time	1/100000s~1s	
	Digital Zoom	16X	
	Day/Night Mode	Day/Night/Auto/Customize/Schedule	
S/N	>55dB		
Lens	Focal Length	5.3~64mm, 12X Optical Zoom	11~55mm, 5X Optical Zoom
	Zoom Speed	Approx 4s (Wide-Tele)	Approx 3.5s (Wide-Tele)
	Field of View	H61°~H5°/D69°~D5°/V36°~V2°	H34°~H8°/D39°~D9°/V20°~V4°
	Focus Control	Auto/Semi-Auto/Manual	
	Minimum Working Distance	1000/1500mm (Wide/Tele)	
	Aperture	F1.6~F2.8	F1.7~F2.1
	Iris Control	Auto	
Road Traffic Management	Max. Vehicle Speed	200km/h	
	Recognition Accuracy	>95%	
	Coverage	Support simultaneous detection of 4 regions	
	Country Region Supported	More than 80 countries and regions	
	Illumination Distance	Up to 175m during the day; Up to 60m during the night with illumination	Up to 110m during the day; Up to 50m during the night with illumination
	Attributes Identification	Plate Color, Vehicle Type, Vehicle Color, Vehicle Brand, No-plate Vehicle Capture	
	Smart Traffic Function	Evidence Camera Linkage, Vehicle Counting Based on Vehicle Type, Specific Lane Management	
	White/Black List	Up to 1000 records inside the camera	
	LPR Smart Search	Support	
Interface	Ethernet	1*RJ45 10M/100M Ethernet Port	
	Audio I/O	1/1 (Optional)	1/1
	Alarm I/O	1/1 (Optional)	1/1
PTZ	Pan Range/Pan Speed	360°endless / Pan Manual Speed: 0.1°~50°/s, Pan Preset Speed: 50°/s	360°endless / Pan Manual Speed: 0.1°~60°/s, Pan Preset Speed: 60°/s
	Tilt Range/Tilt Speed	-45°~30° / Tilt Manual Speed: 0.1°~25°/s, Tilt Preset Speed: 25°/s	-45°~30° / Tilt Manual Speed: 0.1°~30°/s, Tilt Preset Speed: 30°/s
	Proportional Zoom	Support	
	Preset Quantity	300	
	Patrol	8 Patrols, up to 48 presets each patrol	
	Pattern	4 Patterns	
	Power Off Memory	Support	
Other Function	Auto Scan, Auto Home, Preset Freezing, 3D Positioning, PTZ Limits, Initial Position		



Video	Max. Image Resolution	1920x1080	
	Primary Stream	60Hz/50Hz: 100fps@(1920x1080, 1280x960, 1280x720, 704x576)	
	Secondary Stream	60Hz: 60fps@(704x576, 640x480, 640x360, 352x288, 320x240, 320x192, 320x180) 50Hz: 50fps@(704x576, 640x480, 640x360, 352x288, 320x240, 320x192, 320x180)	
	Tertiary Stream	60Hz: 30fps@(1920x1080, 1280x720, 704x576, 640x480, 640x360, 320x240, 320x192, 320x180) 50Hz: 25fps@(1920x1080, 1280x720, 704x576, 640x480, 640x360, 320x240, 320x192, 320x180)	
	Video Compression	H.265*/H.265(HEVC)/H.264*/H.264/MJPEG	
	Video Bit Rate	16Kbps~16Mbps(CBR/VBR Adjustable)	
	Privacy Masking	Up to 28 areas(24 mask areas and 4 mosaic areas)	
	ROI	Up to 8 areas	
	Image Setting	Brightness/Contrast/Saturation/Sharpness	
Network	Network Storage	NAS(Support NFS, SMB/CIFS), ANR	
	Protocol	IPv4/IPv6, ARP, TCP, UDP, RTCP, RTP, RTSP, RTMP, HTTP, HTTPS, DNS, DDNS, DHCP, FTP, NTP, SMTP, SNMP, UPnP, Bonjour, SIP, PPPoE, VLAN, 802.1x, QoS, IGMP, ICMP, SSL	
Audio	Audio Compression	G.711/AAC/G.722/G.726	
	Audio Sampling Rate	8/16/32/44.1/48KHz	
	Audio Bit Rate	16~256kbps	
	Two-way Audio	Support	
System	System Compatibility	API, HTTP, TCP, ONVIF Profile G & Q & S & T	
	Storage	Support microSD/SDHC/SDXC Card Local Storage, up to 256G	
	Advanced Function	BLC, HLC, 2D DNR, 3D DNR, Defog, AWB, EIS, IP Address Filtering, AGC, Anti-flicker, Corridor Mode, Deblur, Watermark	
	SIP/VoIP Support	Yes, Voice & Video-over-IP	
	Event Trigger	Black/White List, Attributes Event, Motion Detection, Network Disconnection, External Input (Optional), Audio Alarm (Optional), etc.	Black/White List, Attributes Event, Motion Detection, Network Disconnection, External Input, Audio Alarm, etc.
	Event Action	FTP Upload, SMTP Upload, SD Card Record, External Output (Optional), SIP Phone, White LED, PTZ Motion, HTTP Notification, etc.	FTP Upload, SMTP Upload, SD Card Record, External Output, SIP Phone, White LED, PTZ Motion, HTTP Notification, etc.
General	Working Temperature	-40°C~60°C	
	Working Humidity	0~95%(Non-condensing)	
	Power Supply	PoE (802.3at) / DC 12V/2A±10%	PoE (802.3at) / DC 12V/3A±10%
	Power Consumption	15W MAX 20W MAX (With IR on)	12W MAX 28W MAX (With IR on)
	Weather Proof	Up to IP66-rated for Weather-resistant Performance	
	Weight	2Kg (Wall Mount) / 1.8Kg (Pedestal Mount)	2.9Kg
	Dimensions	160mmX273.5mmX210mm (Wall Mount) /218mmX120mmX172mm (Pedestal Mount)	110mmX337mmX220mm
	Warranty	2 Years / 3 Years (Optional)	



	Name	AI Road Traffic Speed Dome Camera	
Camera	Appearance		
	Model	TS2841-X36TPC (2MP)	TS2841-X36TPC /W (2MP)
	Image Sensor	1/2" Progressive Scan CMOS	
	Min. Illumination	Color: 0.002Lux@F1.55 B/W: 0Lux with IR on	
	WDR	140dB Super WDR Pro	
	Shutter Time	1/100000s~1s	
	Digital Zoom	16X	
	Day/Night Mode	Day/Night/Auto/Customize/Schedule	
	S/N	>55dB	
	Lens	Focal Length	5.7~205.2mm, 36X Optical Zoom
Zoom Speed		Approx 7s (Wide-Tele)	
Field of View		H63°~H3°/D69°~D3°/ V38°~V1°	
Focus Control		Auto/Semi-Auto/Manual	
Minimum Working Distance		1500/1500mm (Wide/Tele)	
Aperture		F1.55~F4.8	
Iris Control		Auto	
Road Traffic Management	Max. Vehicle Speed	200km/h	
	Recognition Accuracy	>95%	
	Coverage	Support simultaneous detection of 4 regions	
	Country Region Supported	More than 80 countries and regions	
	Illumination Distance	Up to 290m during the day; Up to 110m during the night with illumination	
	Attributes Identification	Plate Color, Vehicle Type, Vehicle Color, Vehicle Brand, No-plate Vehicle Capture	
	Smart Traffic Function	Evidence Camera Linkage, Vehicle Counting Based on Vehicle Type, Specific Lane Management	
	White/Black List	Up to 1000 records inside the camera	
LPR Smart Search	Support		
Interface	Ethernet	1*RJ45 10M/100M Ethernet Port	
	Audio I/O	1/1	
	Alarm I/O	4/2	
	RS485	Support	
PTZ	Pan Range/Pan Speed	360°endless / Pan Manual Speed: 0.1°~250°/s, Pan Preset Speed: 250°/s	
	Tilt Range/Tilt Speed	-5°~90°(Auto Flip) / Tilt Manual Speed: 0.1°~160°/s, Tilt Preset Speed: 160°/s	
	Proportional Zoom	Support	

Road Traffic Management



PTZ	Preset Quantity	300	
	Patrol	8 Patrols, up to 48 presets each patrol	
	Pattern	4 Patterns	
	Power Off Memory	Support	
	Other Function	Auto Scan, Auto Home, Preset Freezing, 3D Positioning, PTZ Limits, Initial Position	
Video	Max. Image Resolution	1920x1080	
	Primary Stream	60Hz/50Hz: 100fps@(1920x1080, 1280x960, 1280x720, 704x576)	
	Secondary Stream	60Hz: 60fps@(704x576, 640x480, 640x360, 352x288, 320x240, 320x192, 320x180) 50Hz: 50fps@(704x576, 640x480, 640x360, 352x288, 320x240, 320x192, 320x180)	
	Tertiary Stream	60Hz: 30fps@(1920x1080, 1280x720, 704x576, 640x480, 640x360, 320x240, 320x192, 320x180) 50Hz: 25fps@(1920x1080, 1280x720, 704x576, 640x480, 640x360, 320x240, 320x192, 320x180)	
	Video Compression	H.265+/H.265(HEVC)/H.264+/H.264/MJPEG	
	Video Bit Rate	16Kbps~16Mbps(CBR/VBR Adjustable)	
	Privacy Masking	Up to 28 areas(24 mask areas and 4 mosaic areas)	
	ROI	Up to 8 areas	
	Image Setting	Brightness/Contrast/Saturation/Sharpness	
Network	Network Storage	NAS(Support NFS, SMB/CIFS), ANR	
	Protocol	IPv4/IPv6, ARP, TCP, UDP, RTCP, RTP, RTSP, RTMP, HTTP, HTTPS, DNS, DDNS, DHCP, FTP, NTP, SMTP, SNMP, UPnP, Bonjour, SIP, PPPoE, VLAN, 802.1x, QoS, IGMP, ICMP, SSL	
Audio	Audio Compression	G.711/AAC/G.722/G.726	
	Audio Sampling Rate	8/16/32/44.1/48KHz	
	Audio Bit Rate	16~256kbps	
	Two-way Audio	Support	
System	System Compatibility	API, HTTP, TCP, ONVIF Profile G & Q & S & T	
	Storage	Support microSD/SDHC/SDXC Card Local Storage, up to 256G	
	Advanced Function	BLC, HLC, 2D DNR, 3D DNR, Defog, AWB, EIS, IP Address Filtering, AGC, Anti-flicker, Corridor Mode, Deblur, Watermark	
	SIP/VoIP Support	Yes, Voice & Video-over-IP	
	Event Trigger	Black/White List, Attributes Event, Motion Detection, Network Disconnection, External Input, Audio Alarm, etc.	
	Event Action	FTP Upload, SMTP Upload, SD Card Record, External Output, SIP Phone, PTZ Motion, HTTP Notification, etc.	
General	Working Temperature	-40°C~60°C	
	Working Humidity	0~95%(Non-condensing)	
	Power Supply	PoE (802.3at) / AC 24V/3A±10%	
	Power Consumption	13W MAX / 23W MAX (With IR on)	
	Weather Proof	Up to IP66-rated for Weather-resistant Performance / Vandal-proof IK10-rated Metal Housing(Optional)	Up to IP66-rated for Weather-resistant Performance
	Heater	Support	
	Wiper	-	Support
	Surge Protection	6KV	
	Dimensions/Weight	Φ205mmX308mm/4Kg	
	Warranty	2 Years / 3 Years (Optional)	



	Name	AI Road Traffic Parking Detection Pro Bullet Plus Camera
Camera	Appearance	
	Model	TS8266-FPC /P (2MP)
	Image Sensor	1/1.8" Progressive Scan CMOS
	Min. Illumination	Color: 0.009Lux@F1.4 B/W: 0Lux with IR on
	WDR	120dB Super WDR
	Shutter Time	1/100000s~1s
	Day/Night Mode	Day/Night/Auto/Customize/Schedule
	S/N	>55dB
Lens	Lens	Motorized 3.6~10mm@F1.4
	Field of View	H116°~H48°/D134°~D55°/V65°~V27°
	Mount	Φ14
	Focus Control	Auto/Manual
Road Traffic Management	Smart Traffic Function	Parking Detection, Parking Violation Detection
	Detection Space	Support simultaneous detection of 4 parking spaces Support simultaneous detection of 2 illegal parking areas
	Recognition Accuracy	98%
	Attributes Identification	Plate Color, Vehicle Type, Vehicle Color, Vehicle Brand, No-plate Vehicle Capture
	Max. Vehicle Speed	200km/h
	Illumination Distance	Up to 65m
	Country Region Supported	More than 80 countries and regions
Parking Smart Search	Support	
Interface	Ethernet	1*RJ45 10M/100M Ethernet Port
	Audio I/O	1/1
	Alarm I/O	1/1
Video	Max. Image Resolution	3840x2160
	Primary Stream	60Hz: 30fps@(3840x2160, 3072x2048, 2592x1944, 2592x1520, 2048x1536, 1920x1080, 1280x960, 1280x720, 704x576) 50Hz: 25fps@(3840x2160, 3072x2048, 2592x1944, 2592x1520, 2048x1536, 1920x1080, 1280x960, 1280x720, 704x576)
	Secondary Stream	60Hz: 30fps@(704x576, 640x480, 640x360, 352x288, 320x240, 320x192, 320x180) 50Hz: 25fps@(704x576, 640x480, 640x360, 352x288, 320x240, 320x192, 320x180)
	Tertiary Stream	60Hz: 30fps@(1920x1080, 1280x720, 704x576, 640x480, 640x360, 320x240, 320x192, 320x180) 50Hz: 25fps@(1920x1080, 1280x720, 704x576, 640x480, 640x360, 320x240, 320x192, 320x180)
	Video Compression	H.265*/H.265(HEVC)/H.264*/H.264/MJPEG
	Video Bit Rate	16Kbps~16Mbps(CBR/VBR Adjustable)
	Privacy Masking	Up to 28 areas(24 mask areas and 4 mosaic areas)
	ROI	Up to 8 areas
	Image Setting	Brightness/Contrast/Saturation/Sharpness



Network	Network Storage	NAS(Support NFS, SMB/CIFS), ANR
	Protocol	IPv4/IPv6, ARP, TCP, UDP, RTCP, RTP, RTSP, RTMP, HTTP, HTTPS, DNS, DDNS, DHCP, FTP, NTP, SMTP, SNMP, UPnP, Bonjour, SIP, PPPoE, VLAN, 802.1x, QoS, IGMP, ICMP, SSL
Audio	Audio Compression	G.711/AAC/G.722/G.726
	Audio Sampling Rate	8/16/32/44.1/48KHz
	Audio Bit Rate	16~256kbps
	Two-way Audio	Support
System	System Compatibility	API, HTTP, TCP, ONVIF Profile G & Q & S & T
	Storage	Support microSD/SDHC/SDXC Card Local Storage, up to 256G
	Advanced Function	BLC, HLC, 2D DNR, 3D DNR, Defog, AWB, EIS, IP Address Filtering, AGC, Anti-flicker, Corridor Mode, Deblur, Watermark
	SIP/VoIP Support	Yes, Voice & Video-over-IP
	Event Trigger	Attributes Event, Motion Detection, Network Disconnection, External Input, Audio Alarm, etc.
	Event Action	FTP Upload, SMTP Upload, SD Card Record, External Output, SIP Phone, HTTP Notification, etc
General	Working Temperature	-40℃~60℃
	Working Humidity	0~95%(Non-condensing)
	Power Supply	PoE (802.3af) / DC 12V±10%
	Power Consumption	8W MAX 17W MAX (With IR on)
	Surge Protection	4KV
	Housing	Vandal-proof IK10-rated Metal Housing / Up to IP67-rated for Weather-resistant Performance
	Weight	1630g
	Dimensions	320mmX134mmX126mm
	Warranty	3/5 Years



Structure Diagrams

AI Road Traffic Pro Bullet Plus Camera

microSD/SDHC/SDXC Card Slot

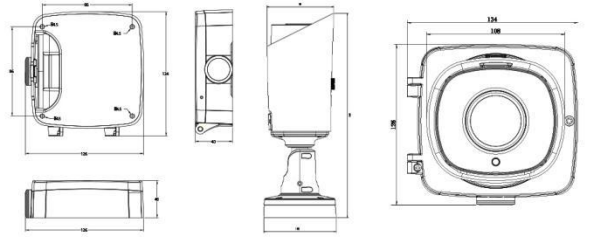
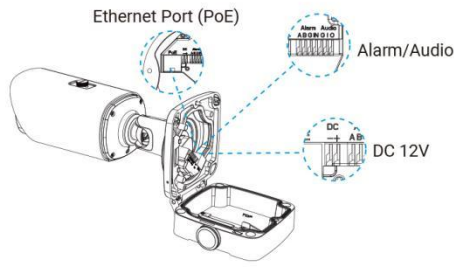
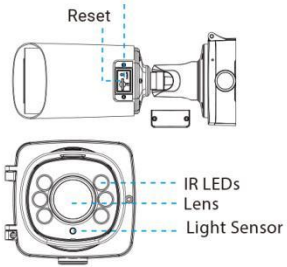

AI Road Traffic Radar Pro Bullet Plus Camera

microSD/SDHC/SDXC Card Slot

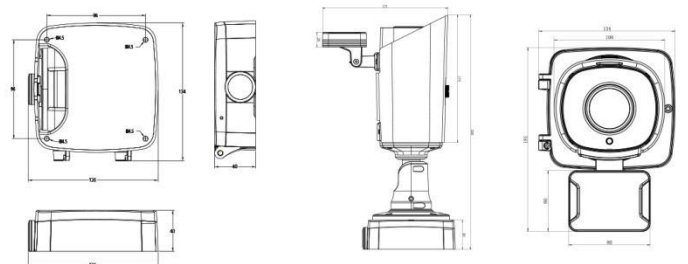
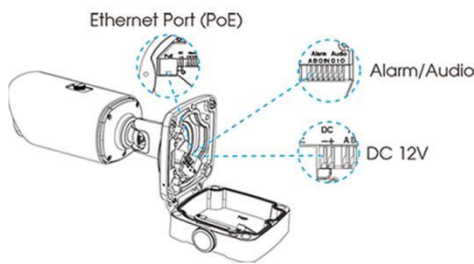
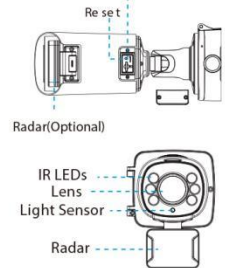

AI Road Traffic Supplement Light Pro Bullet Plus Camera

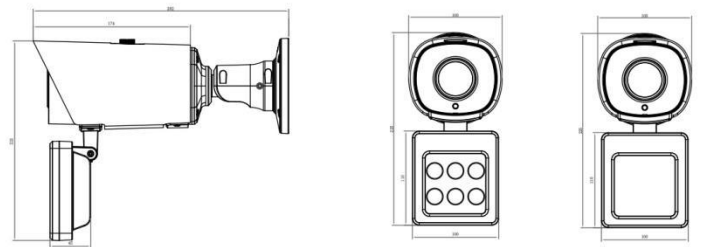
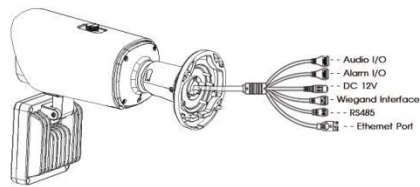
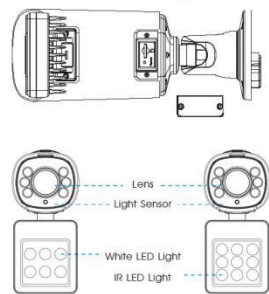

AI Road Traffic 5G Pro Bullet Plus Camera

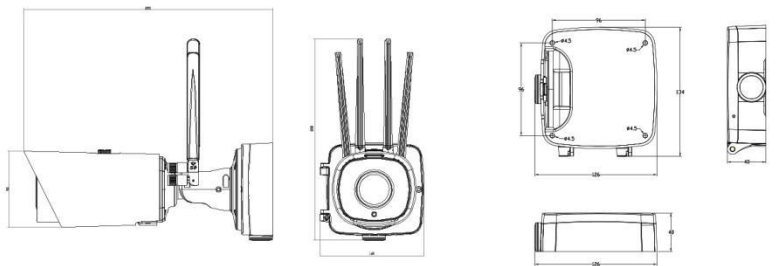
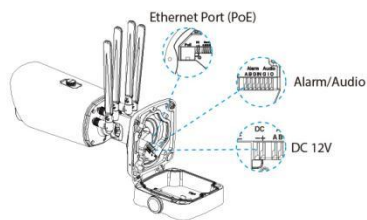
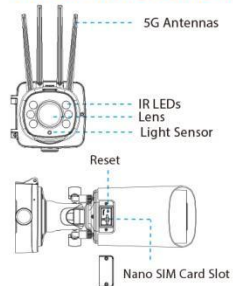

AI Road Traffic PTZ Bullet Camera

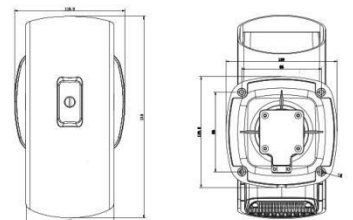
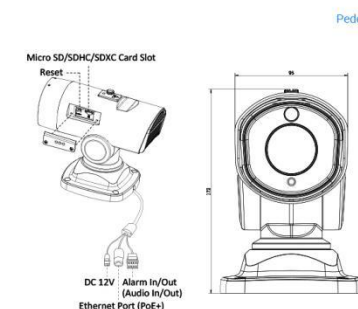
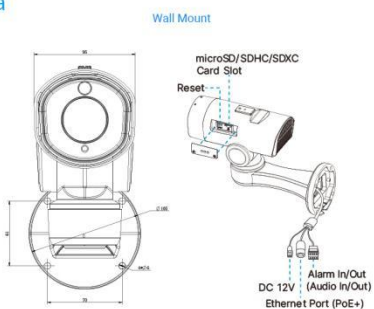
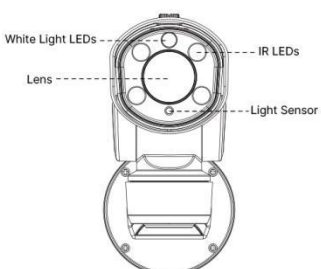

Road Traffic Management



AI Road Traffic PTZ Bullet Plus Camera

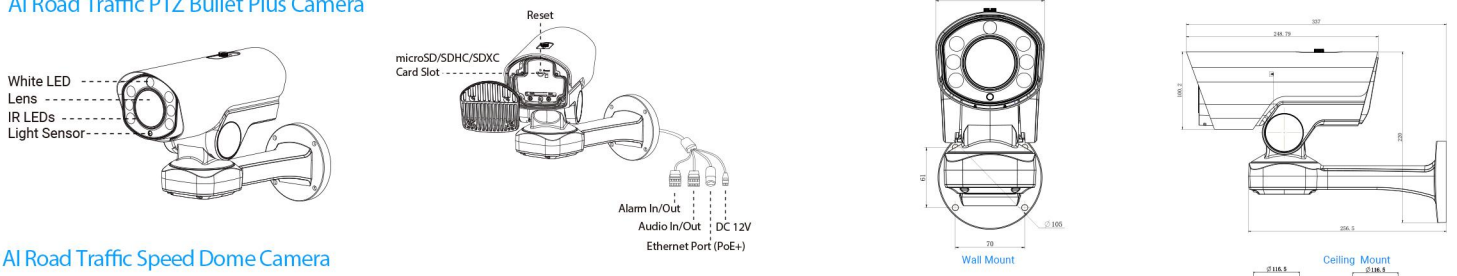

AI Road Traffic Speed Dome Camera

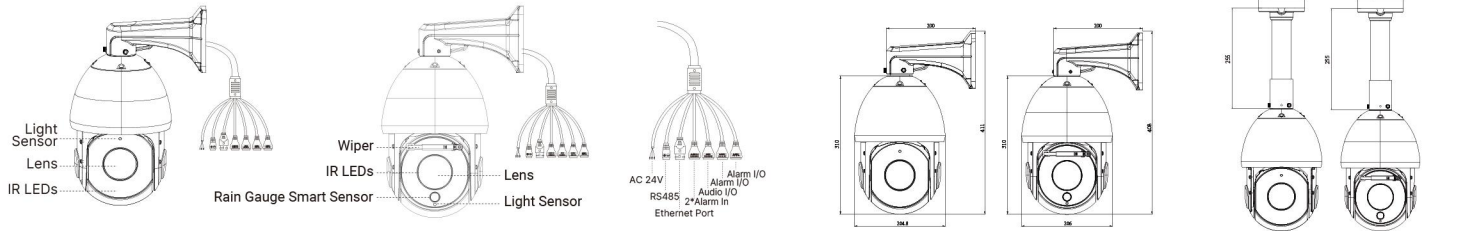

AI Road Traffic Parking Detection Pro Bullet Plus Camera

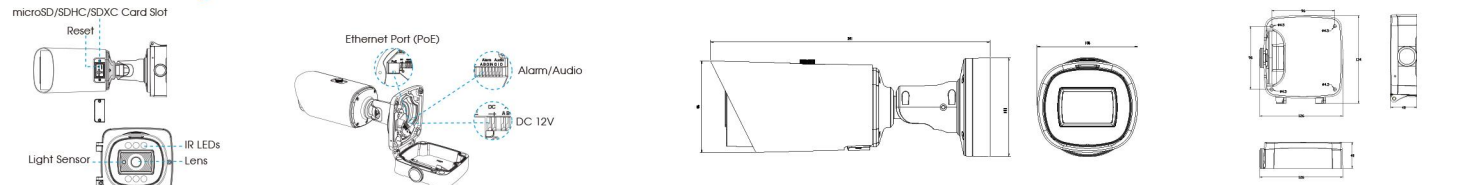

Units: mm

Accessories Support

AI Road Traffic Pro Bullet Plus Camera / AI Road Traffic Radar Pro Bullet Plus Camera / AI Road Traffic 5G Pro Bullet Plus Camera / AI Road Traffic Parking Detection Pro Bullet Plus Camera

A62 Junction Box (Default)

Weight: 510g
Dimensions: 134*126*40mm



A01 Pole Mount

Weight: 720g
Dimensions: 170*51.5*152.6mm



A03 External Corner Bracket

Weight: 900g
Dimensions: 170*152.5*76.3mm



AI Road Traffic Supplement Light Pro Bullet Plus Camera / AI Road Traffic PTZ Bullet Camera

A62 Junction Box

Weight: 510g
Dimensions: 134*126*40mm



A01 Pole Mount

Weight: 720g
Dimensions: 170*51.5*152.6mm



A03 External Corner Bracket

Weight: 900g
Dimensions: 170*152.5*76.3mm



AI Road Traffic PTZ Bullet Plus Camera

A01 Pole Mount

Weight: 720g
Dimensions: 170*51.5*152.6mm



A03 External Corner Bracket

Weight: 900g
Dimensions: 170*152.5*76.3mm



A62 Junction Box

Weight: 510g
Dimensions: 134*126*40mm



AI Road Traffic Speed Dome Camera

A41 Wall Mount (Default)

Weight: 400g
Dimensions: 200*129*100mm



A01 Pole Mount

Weight: 720g
Dimensions: 170*51.5*152.6mm



A03 External Corner Bracket

Weight: 900g
Dimensions: 170*152.5*76.3mm



A42 Pendant Mount

Weight: 650g
Dimensions: 116.5*255mm



A42-L Extension Lever

Weight: 325g
Dimension: 57*255mm



A43 Junction Box

Weight: 1000g
Dimensions: 195*164*80mm



Milesight | www.milesight.com

Contact Us: sales@milesight.com support@milesight.com

Add: 220 NE 51st Street, Oakland Park, Florida 33334, USA
Tel: +1-800-561-0485

Add: 925, Anyang SK V1 Center, LS-ro 116beon-gil, Dongan-gu, Anvang-si, Korea
Tel: +82-31-990-7732

Add: Building C09, Software Park Phase III, Xiamen 361024, Fujian, China
Tel: +86-592-5922772

