

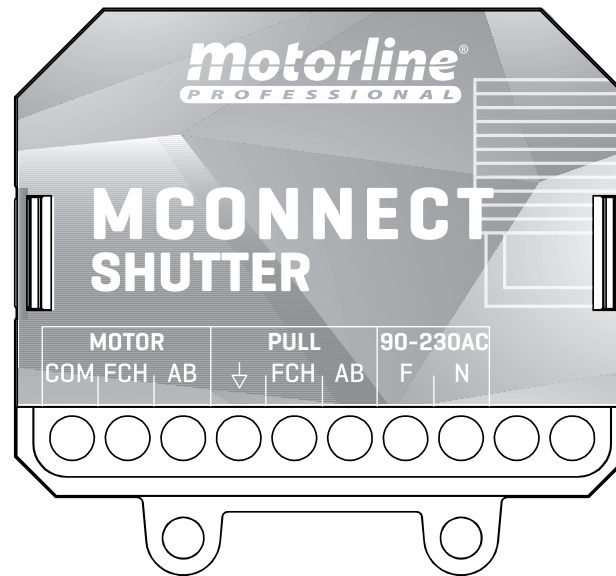

# MCONNECT SHUTTER

## USER'S AND INSTALLER'S MANUAL





# 00. CONTENT

## INDEX

<b>01. SAFETY INSTRUCTIONS</b>	<b>1B</b>
<b>02. CONNECTIONS SCHEME</b>	
CONNECTION TO WALL SWITCH OF 2 KEYS	4A
<b>03. CONTROL BOARD</b>	
MCONNECT SHUTTER	4B
GRAPHIC DESCRIPTION	4B
TECHNICAL SPECIFICATIONS	5A
<b>04. INSTALLATION</b>	
PRODUCT INSTALLATION	5B
<b>05. CONFIGURATION</b>	
OPERATING SETTINGS	6A
ADD MODULE IN IN THE APP	6A
REMOVE MODULE FROM THE APP	6A
RESET	6B
<b>06. TROUBLESHOOTING</b>	
INSTRUCTIONS FOR FINAL CONSUMERS/TECHNICIANS	6B

# 01. SAFETY INSTRUCTIONS

## ATTENTION:

	This product is certified in accordance with European Community (EC) safety standards.
<b>RoHS</b>	This product complies with Directive 2011/65/EU of the European Parliament and of the Council, of 8 June 2011, on the restriction of the use of certain hazardous substances in electrical and electronic equipment and with Delegated Directive (EU) 2015/863 from Commission.
	(Applicable in countries with recycling systems). This marking on the product or literature indicates that the product and electronic accessories (eg. Charger, USB cable, electronic material, controls, etc.) should not be disposed of as other household waste at the end of its useful life. To avoid possible harm to the environment or human health resulting from the uncontrolled disposal of waste, separate these items from other types of waste and recycle them responsibly to promote the sustainable reuse of material resources. Home users should contact the dealer where they purchased this product or the National Environment Agency for details on where and how they can take these items for environmentally safe recycling. Business users should contact their vendor and check the terms and conditions of the purchase agreement. This product and its electronic accessories should not be mixed with other commercial waste.
	This marking indicates that the product and electronic accessories (eg. charger, USB cable, electronic material, controls, etc.) are susceptible to electric shock by direct or indirect contact with electricity. Be cautious when handling the product and observe all safety procedures in this manual.

# 01. SAFETY INSTRUCTIONS

## **GENERAL WARNINGS**

- This manual contains very important safety and usage information. very important. Read all instructions carefully before beginning the installation/usage procedures and keep this manual in a safe place that it can be consulted whenever necessary.
- This product is intended for use only as described in this manual. Any other enforcement or operation that is not mentioned is expressly prohibited, as it may damage the product and put people at risk causing serious injuries.
- This manual is intended firstly for specialized technicians, and does not invalidate the user's responsibility to read the "User Norms" section in order to ensure the correct functioning of the product.
- The installation and repair of this product may be done by qualified and specialized technicians, to assure every procedure are carried out in accordance with applicable rules and norms. Nonprofessional and inexperienced users are expressly prohibited of taking any action, unless explicitly requested by specialized technicians to do so.
- Installations must be frequently inspected for unbalance and the wear signals of the cables, springs, hinges, wheels, supports and other mechanical assembly parts.
- Do not use the product if it is necessary repair or adjustment is required.
- When performing maintenance, cleaning and replacement of parts, the product must be disconnected from power supply. Also including any operation that requires opening the product cover.
- The use, cleaning and maintenance of this product may be carried out by any persons aged eight years old and over and persons whose physical, sensorial or mental capacities are lower, or by persons without any knowledge of the product, provided that these are supervision and instructions given by persons with experienced in terms of usage of the product in a safe manner and who understands the risks and dangers involved.

- Children shouldn't play with the product or opening devices to avoid the motorized door or gate from being triggered involuntarily.

## **WARNINGS FOR TECHNICIANS**

- Before beginning the installation procedures, make sure that you have all the devices and materials necessary to complete the installation of the product.
- You should note your Protection Index (IP) and operating temperature to ensure that is suitable for the installation site.
- Provide the manual of the product to the user and let them know how to handle it in an emergency.
- If the automatism is installed on a gate with a pedestrian door, a door locking mechanism must be installed while the gate is in motion.
- Do not install the product "upside down" or supported by elements do not support its weight. If necessary, add brackets at strategic points to ensure the safety of the automatism.
- Do not install the product in explosive site.
- Safety devices must protect the possible crushing, cutting, transport and danger areas of the motorized door or gate.
- Verify that the elements to be automated (gates, door, windows, blinds, etc.) are in perfect function, aligned and level. Also verify if the necessary mechanical stops are in the appropriate places.
- The central must be installed on a safe place of any fluid (rain, moisture, etc.), dust and pests.
- You must route the various electrical cables through protective tubes, to protect them against mechanical exertions, essentially on the power supply cable. Please note that all the cables must enter the central from the bottom.
- If the automatism is to be installed at a height of more than 2,5m from the ground or other level of access, the minimum safety and health requirements for the use of work equipment workers at the work of Directive 2009/104/CE of European Parliament and of the Council of

# 01. SAFETY INSTRUCTIONS

16 September 2009.

- Attach the permanent label for the manual release as close as possible to the release mechanism.
- Disconnect means, such as a switch or circuit breaker on the electrical panel, must be provided on the product's fixed power supply leads in accordance with the installation rules.
- If the product to be installed requires power supply of 230Vac or 110Vac, ensure that connection is to an electrical panel with ground connection.
- The product is only powered by low voltage safety with central (only at 24V motors)

## WARNINGS FOR USERS

- Keep this manual in a safe place to be consulted whenever necessary.
- If the product has contact with fluids without being prepared, it must immediately disconnect from the power supply to avoid short circuits, and consult a specialized technician.
- Ensure that technician has provided you the product manual and informed you how to handle the product in an emergency.
- If the system requires any repair or modification, unlock the automatism, turn off the power and do not use it until all safety conditions have been met.
- In the event of tripping of circuits breakers or fuse failure, locate the malfunction and solve it before resetting the circuit breaker or replacing the fuse. If the malfunction is not repairable by consult this manual, contact a technician.
- Keep the operation area of the motorized gate free while the gate in motion, and do not create strength to the gate movement.
- Do not perform any operation on mechanical elements or hinges if the product is in motion.

## RESPONSABILITY

- Supplier disclaims any liability if:
  - Product failure or deformation result from improper installation use or maintenance!
  - Safety norms are not followed in the installation, use and maintenance of the product.
  - Instructions in this manual are not followed.
  - Damaged is caused by unauthorized modifications
  - In these cases, the warranty is voided.

## SYMBOLS LEGEND:



• Important safety notices



• Useful information



• Programming information



• Potentiometer information



• Connectors information



• Buttons information

## 02. CONNECTIONS SCHEME

### CONNECTION TO WALL SWITCH OF 2 KEYS

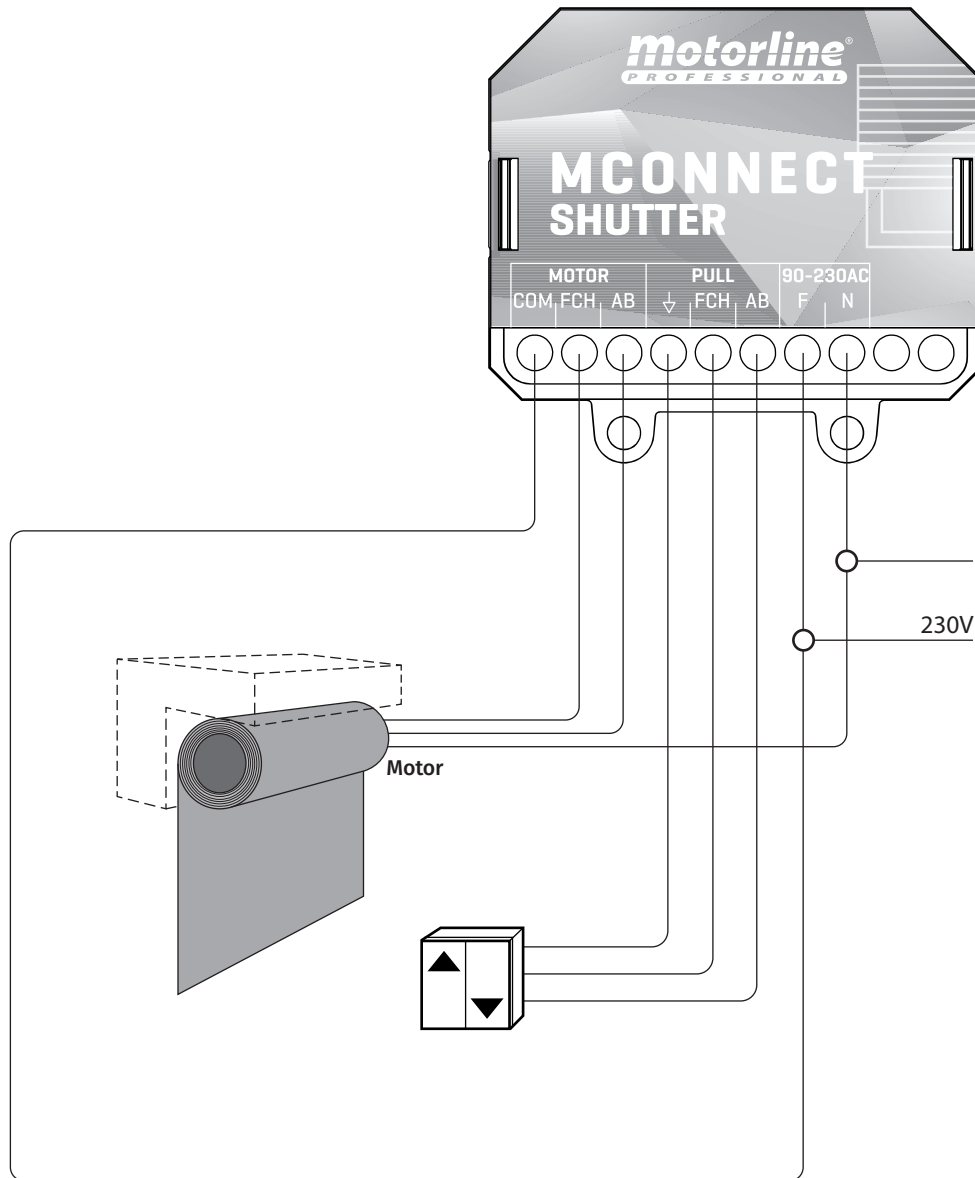

## 03. CONTROL BOARD

### MCONNECT SHUTTER

The MCONNECT SHUTTER was developed to control roller shutters by distance or push button, using the MCONNECT app and a module previously connected to the application. Its small size allows the installation inside a junction boxes, behind electrical switches (push buttons).

#### Advantages of using MCONNECT:

- Easy installation and configuration;
- Possibility to control the lights in your home from anywhere;
- Reading the status of electric shutters, recognizing the opening/closing state and/or its opening percentage;
- Recognizing the opening/closing state and/or its opening percentage;
- Possibility of configuring routines for the devices (example: open the electric shutter at 10am and close at 10.30am).

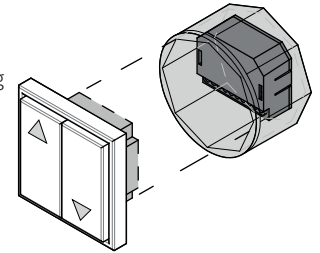

### GRAPHIC DESCRIPTION

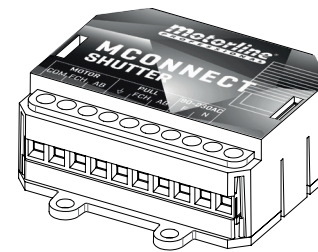

MOTOR	COM	Motor Output - Common
	FCH	Motor Output - Close
	AB	Motor Output - Open
PULL	↓	Wall switch connection - Common
	FCH	Wall switch connection - Close (NA)
	AB	Wall switch connection - Open (NA)
90-230AC	F	230V line input (phase)
	N	230V line input (neutral)

LEDS	• Flash in purple	Pairing mode (It is waiting to be added)
	• Red	No network
	• Flash in red	Lost connection to the cloud
	• Blues	Successfully connected to the local network, but not yet connected to the cloud
	• Flash in blue	Upgrading Firmware
	• Green	Connected to the cloud

## 03. CONTROL BOARD

### TECHNICAL SPECIFICATIONS

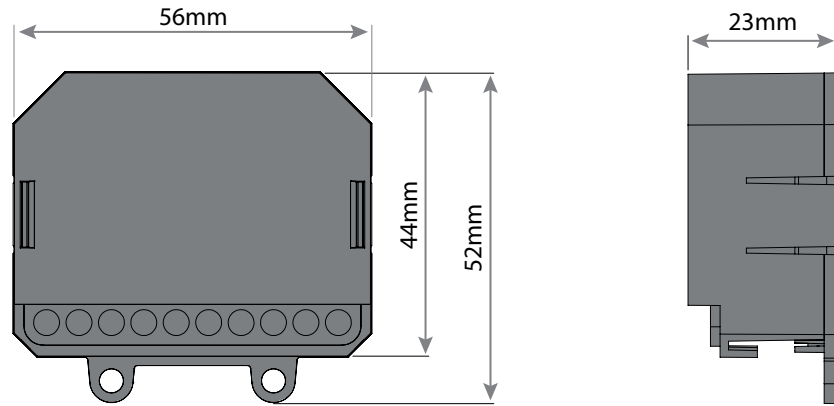

• Power Supply	90-230 Vac 50-60Hz
• Maximum engine power	230Vac; 750W
• Output relay capacity	5A 250VAC 5A 30VDC
• Consumption	15mA @ 230AC
• Operating temperature	-20°C to 70°C
• Module frequency	2.4 GHz
• Input	2 contact inputs without tension
• Output	2 relay outputs without tension
• Technology	WIFI IEEE 802.11b/g/n , Bluetooth
• Wifi access	50m in open country
• Protection level	IP44
• Construction material	ABS

- The existence of a Wi-Fi network is required in the space where the device will be working;
- The device must be installed behind a normal switch, inside the junction box, passing all light control to be performed by the device.

## 04. INSTALLATION

### PRODUCT INSTALLATION

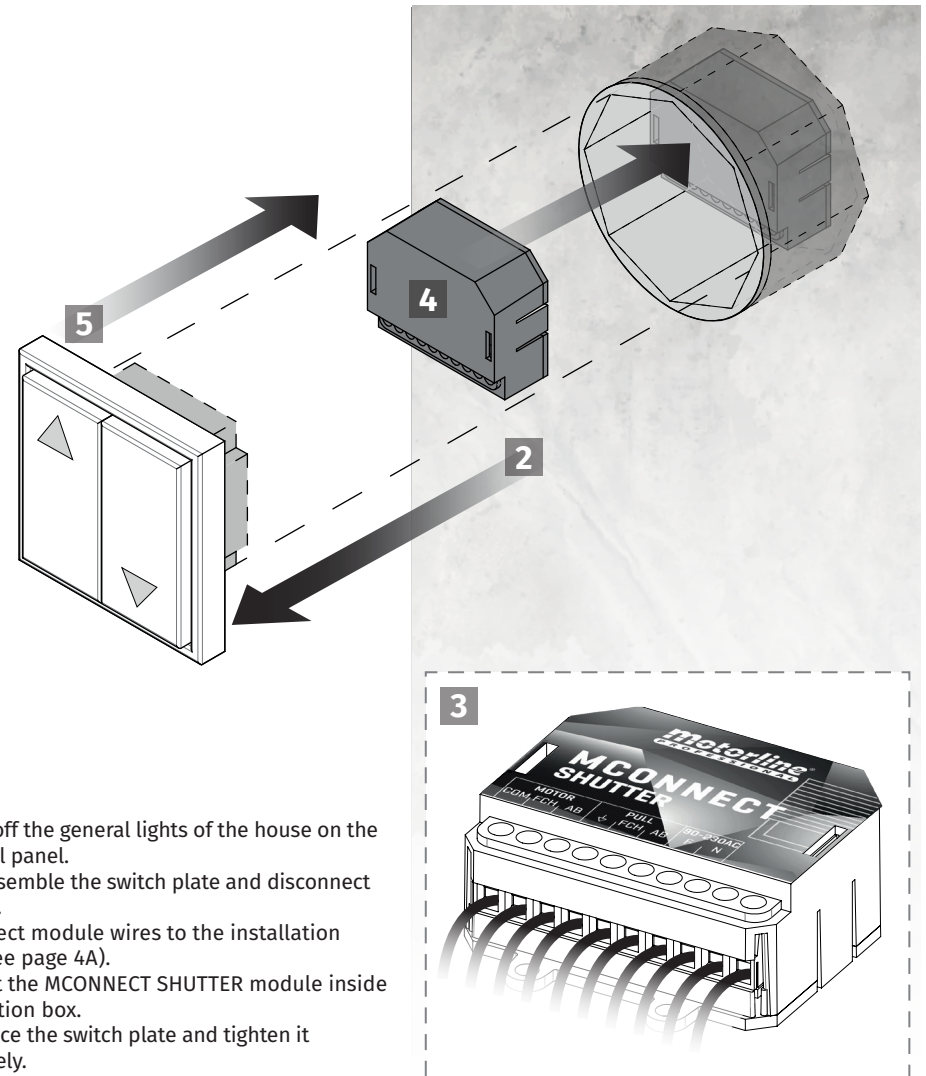

- 1 • Turn off the general lights of the house on the electrical panel.
- 2 • Disassemble the switch plate and disconnect all wires.
- 3 • Connect module wires to the installation wires (see page 4A).
- 4 • Insert the MCONNECT SHUTTER module inside the junction box.
- 5 • Replace the switch plate and tighten it completely.

## 05. CONFIGURATION

### OPERATING SETTINGS

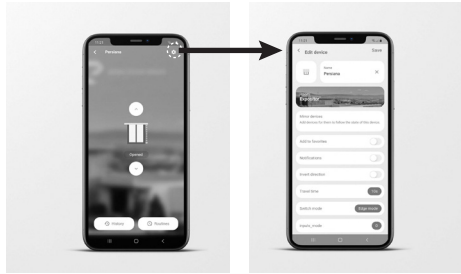

#### SWITCH MODE

##### • PULSE

The shutter changes state when the pulse switch is pressed.

##### • EDGE MODE

Changes the state (ON or OFF) when switch changes the position.

Ex: If the wall switch is in the open position and the shutter is closed, turning the switch to the closed position will open the shutter.

#### INPUTS MODE

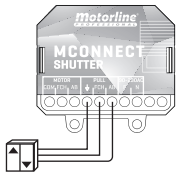

##### • SWITCHES MODE

Inputs are both used as switches. FCH to close and AB to open.

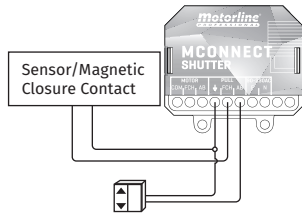

##### • SWITCH AND SENSOR MODE

Input AB acts as a pulse switch (ignores Switch Mode), controlling up and down. The FCH input is used as a sensor/closing contact.

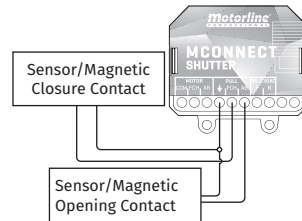

##### • SENSORS MODE

Input AB is used as opening sensor and FCH as sensor/closing contact.

#### REVERSE DIRECTION

This mode, when active, inverts the outputs to the motor. The opening exit starts to close and vice versa. It is used when the installer makes the connections in reverse.

#### OPENING TIME

Used to indicate the time takes by the shutter to open/close, so that the opening control feedback is as real as possible.

## 05. CONFIGURATION

### ADD MODULE IN IN THE APP

- 1 • Open MCONNECT app.
  - 2 • Log in.
  - 3 • On the home page press the "+" button at the top right.
  - 4 • Press Add new MCONNECT.
  - 5 • Accept all requested permissions.
  - 6 • Turn on the power.
  - 7 • Check that the module is in pairing mode (flashing purple).
- Note** • if it is not in pairing mode it is necessary to reset.
- 8 • Read the QR Code on the module box.
  - 9 • If you prefer or don't have the QR Code, can change the button to Scan nearby and select the module in the devices found.
  - 10 • Enter the name and password of the Wifi network you are connected to.
  - 11 • Wait for add process be complete.

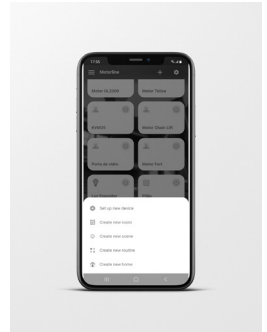

### REMOVE MODULE FROM THE APP

- 1 • Press on the device you want to remove.
- 2 • Press on the icon with a gear symbol on the upper right side of the screen.
- 3 • Press **Remove MCONNECT**.
- 4 • Confirm.

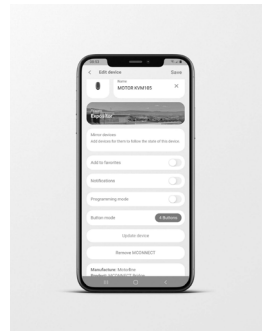

### RESET

When resetting, the device is no longer connected to the account it is associated with in the application.

Press the reset button until the LED changes to pairing mode (flashing purple), which will confirm successful operation.

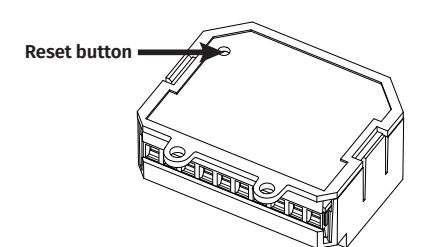

## 06. TROUBLESHOOTING

### INSTRUCTIONS FOR FINAL CONSUMERS/TECHNICIANS

PROBLEM	SOLUTION
The LED reader does not light up	Check that the power is connected correctly.
The module is not in pairing mode (LED flashing purple) and I haven't configured it yet	Press the Reset button located on the back of the module, until it switches to pairing mode.
The module has the red LED	Make sure the network you configured the module on is available. Check if you have coverage of the network to which the module is connected. Check if the network you have configured the module has Internet access.
The module has the blue LED	Check if the network you configure the module has Internet access.
The output does not change state	Check that the connections are correct.
The switch does not change the state output	Make sure the connections are correct. Check the App if the switch mode is in the correct mode.