

RELIABLE ADAPTABILITY
FOR SECURITY SYSTEMS

The background of the lower half of the page is a dark field filled with a dense, undulating pattern of small white dots, creating a sense of depth and movement, similar to a digital signal or a data visualization.

**ARE YOU READY
FOR THE 3G NETWORK
SHUTDOWN?**

“ Our mission

is to simplify and accelerate technological change in security services by creating equipment that is easy to install and use.

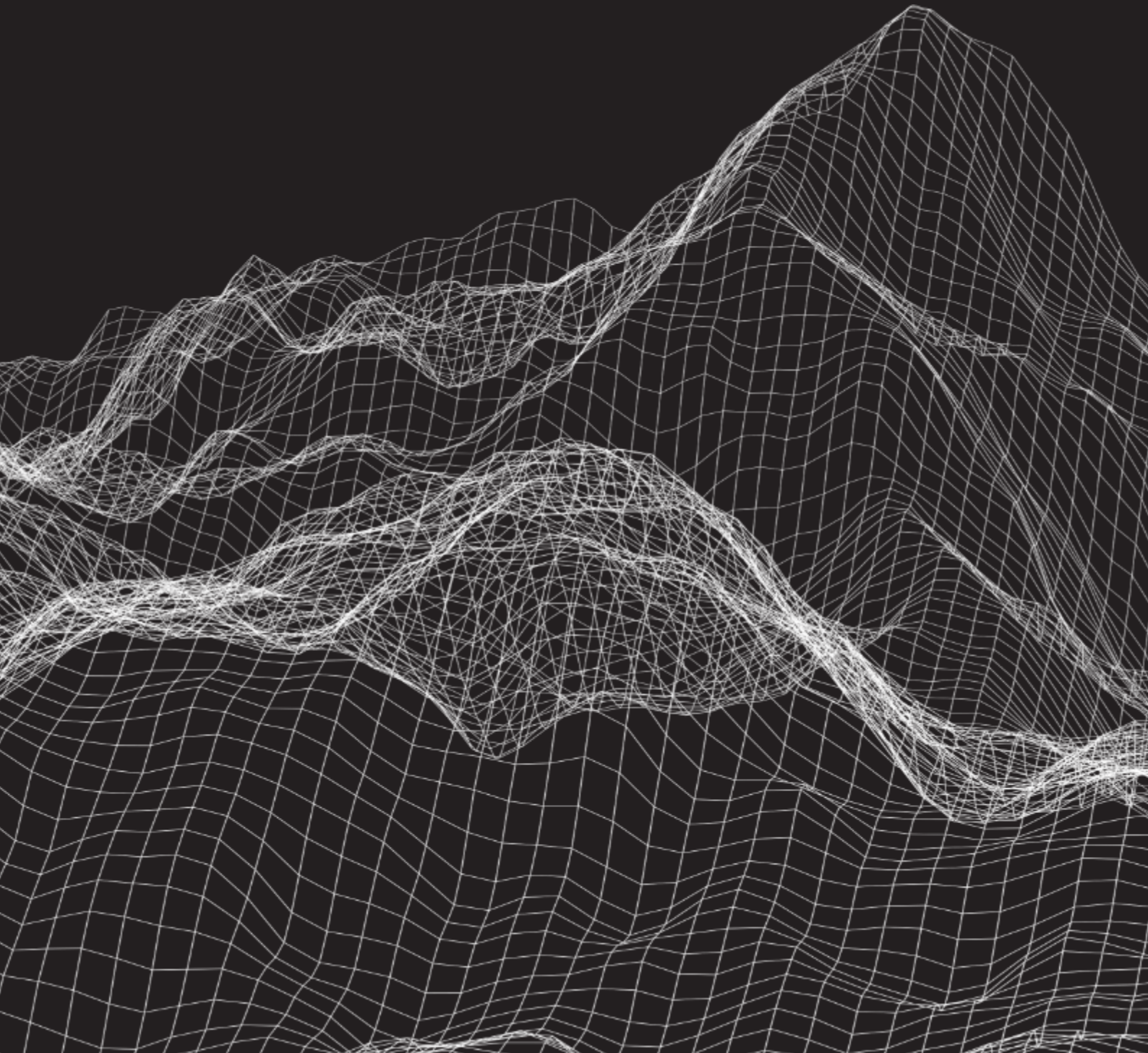

We are designing and manufacturing alarm messaging equipment for security companies that are looking to use new communications solutions and gain a technological edge.

UAB TRIKDIS was established in 1996 as a joint initiative between scientists from Kaunas University of Technology and one of the first Lithuanian security companies “Jungtis”.

From there we grew to an independent company, working with both small and big security companies around the world.

Our first VHF/UHF radio transmitters were created back in the year 2000.

Most of them are still in use for transmitting signals from various secured objects. Using the experience and knowledge we've gathered through years, we developed cellular and Internet (Ethernet) communicators with more advanced features.



G16

The G16 connects to compatible DSC, Paradox, UTC Interlogix (CADDX), Innerrange, Texecom, Honeywell, Crow and Pyronix alarm panels.

Also its perfect tool to remotely monitor and control devices and systems to detect faults and malfunctions in seconds to minimise downtime and maximise services efficient

Reliable communication:



- communication with two different CMS at same time
- +backup channels
- *reported to CMS with SMS messages when IP connection stops.
- Supervision heartbeats

Fast and easy setup



- USB connector for setup via PC.
- Slot for SIM card of any GSM operator
- Control by Protegus mobile app.
- *Control by SMS.

Controllable outputs and inputs:



- 3 double I/O terminals
- Add additional inputs and controllable outputs with iO-8 expanders.



*SMS features - not available in North America



highest EN50131

SPECIFICATIONS ▼

Connects to panel	Serial or keypad bus
Dual purpose terminals [IN/OUT]	3, can be set as either NC; NO; NC/EOL; NO/EOL; NC/DEOL; NO/DEOL (2,2 kΩ) type inputs or open collector (OC) type outputs with current up to 0,15 A, 30 VDC max. Expandable with iO-8 series expanders.
LTE FDD	B1/B2/B3/B4/B5/B7/B8/B12/B13/B18/B19/B20/B25/B26/B28
LTE TDD	B38/B39/B40/B41
UMTS	B1/B2/B4/B5/B6/B8/B19
GSM	850/900/1800/1900 MHz
Power supply voltage	10-18 V DC
Current consumption	60-100 mA (on standby) Up to 500 mA (while sending data)
Transmission protocols	TRK, DC-09_2007, DC-09_2012, TL150
Message encryption	AES 128
Changing settings	With TrikdisConfig computer program remotely or locally via USB Mini-B port Remotely with SMS messages
Operating environment	Temperature from -10 °C to +50 °C, relative humidity - up to 80% at +20 °C
Communicator dimensions	92 x 62 x 26 mm
Weight	80 g

COMPATIBILITY ▼

Manufacturer	Model
DSC®	PC585 , PC1404, PC1565 , PC1616 , PC1832 , PC1864 , C5015, PC5020
PARADOX®	SPECTRA SP4000 , SP5500 , SP6000 , SP7000 , SP65 MAGELLAN MG5000 , MG5050 , MG5050E , MG5075 DIGIPLEX EVO48 , EVO192 , EVOHD , NE96, EVO96 SPECTRA 1727, 1728, 1738 ESPRIT E55, 728ULT, 738ULT
UTC Interlogix®	NetworX (Caddx) NX-4v2 , NX-6v2 , NX-8v2 , NX-8e
Texecom®	Premier 24 , 48 , 88 , 168 Premier Elite 12 , 24 , 48 , 64 , 88 , 168
Pyronix®	MATRIX 424, MATRIX 832, MATRIX 832+, MATRIX 6, MATRIX 816
Innerrange®	Inception
Honeywell®	Ademco Vista-15 , Ademco Vista-20 , Ademco Vista-48
Crow®	Runner 4/8, 8/16

*Red – remote Arm/Disarm via Serial bus

** Communicator is compatible with other manufacturer control panels when connected with GSM communicators G16T

G16T



CELULAR COMMUNICATOR

▼ **CELULAR COMMUNICATOR**



Universal

Connects to any alarm panel which has a landline dialer. Supports full transmission Contact ID, SIA or 4+2 event information to security company's monitoring station.



Supervised connection

Polling of the connection as often as 30 seconds.



Works with Protegeus app

Users can arm/disarm their alarm system remotely and receive notifications about events.



4G

Can be ordered with 4G (CatM1 - Narrowband) cellular modems.



Grade 4 Certified

Certified to the highest EN50131 Grade 4 security rating.

Sends events to monitoring station receiver:

- Sends events to TRIKDIS software or hardware receivers that work with any monitoring software.
- Can send event messages to SIA DC-09 receivers.
- Connection supervision by polling to IP receiver every 30 seconds (or by user defined period).
- Backup channel, that will be used if connection with the primary channel is lost.
- Events can be reported to CMS with SMS messages. SMS will be sent even if data connection stops working in the mobile operator network.
- With parallel communication channels, events can be sent to two receivers at same time.
- When Protegus service is enabled, events are first delivered to CMS, and only then are sent to app users.

Works with Protegus app:

- “Push” and special sound notifications informing about events.
- Remote system Arm/Disarm.
- Remote control of connected devices (lights, gates, ventilation systems, heating, sprinklers, etc.).
- Different user rights for administrator, installer and user.

Notifies users:

- Users can be notified about events not only with Protegus app, but also with SMS messages and a call.

Controllable outputs and inputs:

- 3 I/O, selectable type: NC; NO; NC/EOL; NO/EOL; NC/DEOL; NO/DEOL.
- Add additional inputs and controllable outputs with iO-8 expanders.

Quick setup:

- Settings can be saved to file and quickly written to other communicators.
- Two access levels for configuring the device for CMS administrator and for installer.
- Remote configuration and firmware updates.

Connects to panel	Landline dialer (TIP RING contacts)
Dual purpose terminals [IN/OUT]	3, can be set as either NC; NO; NC/EOL; NO/EOL; NC/DEOL; NO/DEOL (10 kΩ) type inputs or open collector (OC) type outputs with current up to 0,15 A, 30 VDC max. Expandable with iO-8 expanders.
2G modem frequencies	850 / 900 / 1800 /1900 MHz
3G modem frequencies	800 / 850 / 900 / 1900 / 2100 MHz
4G modem frequencies	Depends on region: LTE FDD: B1/B2/B3/B4/B5/B8/B12/B13B18/B19/B20/B25/B28 LTE TDD: B39 (only Cat M1) Cat M1/Cat NB1: B1/B2/B3/B4/B5/B8/B12/B13B18/B19/B20/B25/B28
Power supply voltage	10-18 V DC
Current consumption	60-100 mA (on standby) Up to 250 mA (while sending data)
Transmission protocols	TRK, DC-09_2007, DC-09_2012, TL150
Message encryption	AES 128
Changing settings	With TrikdirConfig computer program remotely or locally via USB Mini-B port Remotely with SMS messages
Operating environment	Temperature from -10 °C to 50 °C, relative humidity - up to 80% at +20 °C
Communicator dimensions	92 x 62 x 26 mm
Weight	80 g

E16



ETHERNET COMMUNICATOR



ETHERNET COMMUNICATOR



Full event information

Communicator transmits full event information to the Central Monitoring Station.



Panel integration

Connects to supported panel's serial or keypad bus. This allows the communicator to read and retransmit panel events in less than 1 second.



Stable connection

Ethernet connection delivers a consistently solid connection, lower latency. Ethernet is more reliable in terms of interference.



Works with Protegus app

Users can arm/disarm their alarm system remotely and receive notifications about events.

E16 is not just an Ethernet transmitter that sends messages to compatible security systems. It also transmits the command received over the internet to the system to arm/disarm protection mode.

Sends events to monitoring station receiver:

- Sends events to TRIKDIS software or hardware receivers that work with any monitoring software.
- Can send event messages to SIA DC-09 receivers.
- Frequent connection checks/control in order to quickly detect connection loss.
- Backup channel, that will be used if connection with the primary channel is lost.
- With parallel communication channels events can be sent to two receivers at same time.
- When Protegus service is enabled, events are first delivered to CMS, and only then are sent to app users.

Works with Protegus app:

- “Push” and special sound notifications informing about events.
- Remote system Arm/Disarm.
- Remote control of connected devices (lights, gates, ventilation systems, heating, sprinklers, etc.).
- Different user rights for administrator, installer and user.

Notifies users:

- Users can be notified about events with Protegus app.

Controllable outputs and inputs:

- 3 double I/O terminals that can be set either as input (IN) or controllable output (OUT) terminals.
- Outputs controlled by the Protegus app.
- Add additional inputs and controllable outputs with wired and wireless iO expanders.

Quick setup:

- Settings can be saved to file and quickly written to other communicators.
- Two access levels for configuring the device for CMS administrator and for installer.
- Remote configuration and firmware updates.

Specifications:

Dual purpose terminals [IN/OUT]	3, can be set as either NC; NO; NC/EOL; NO/EOL; NC/DEOL; NO/DEOL (2,2 kΩ) type inputs or open collector (OC) type outputs with current up to 0,15 A, 30 VDC max. Expandable with iO series expanders.
Power supply voltage	10-18 V DC
Current consumption	100 mA (on standby) Up to 250 mA (while sending data)
Ethernet connection	IEEE802.3, 10 Base-T, RJ45 socket
Transmission protocols	TRK, DC-09_2007, DC 09_2012
Memory	Up to 60 messages
Changing settings	With TrikdisConfig computer program remotely or locally via USB Mini-B port
Operating environment	Temperature from -10 °C to 50 °C, relative humidity - up to 80% at +20 °C
Communicator dimensions	88 x 62 x 26 mm
Weight	80 g

Supported intrusion alarm panels:

Manufacturer	Model
DSC®	PC585 , PC1404, PC1565 , PC1616 , PC1832 , PC1864 , C5015, PC5020
PARADOX®	SPECTRA SP4000 , SP5500 , SP6000 , SP7000 , SP65 MAGELLAN MG5000 , MG5050 , MG5050E , MG5075 DIGIPLX EVO48 , EVO192 , EVOHD , NE96, EVO96 SPECTRA 1727, 1728, 1738 ESPRIT E55, 728ULT, 738ULT
UTC Interlogix®	NetworX (Caddx) NX-4v2 , NX-6v2 , NX-8v2 , NX-8e
Texecom®	Premier 24 , 48 , 88 , 168 Premier Elite 12 , 24 , 48 , 64 , 88 , 168
Pyronix®	MATRIX 424, MATRIX 832, MATRIX 832+, MATRIX 6, MATRIX 816
Innerrange®	Inception
Honeywell®	Ademco Vista-15 , Ademco Vista-20 , Ademco Vista-48
Crow®	Runner 4/8, 8/16

*Red – remote Arm/Disarm via Serial bus

** Communicator is compatible with other manufacturer control panels when connected with GSM communicators E16T

E16T



ETHERNET COMMUNICATOR



Universal

Connects to any alarm panel that has a landline dialer and supports dialing in Contact ID protocol and DTMF tones. Transmits full Contact ID event information to security company's monitoring station.



Supervised connection

Polling of the connection as often as 10 seconds.



Works with Protegus app

Customers are informed about security system events in Protegus app. They can Arm/Disarm the alarm system remotely via panel's keyswitch zone.

Sends events to monitoring station receiver:

- Sends events to TRIKDIS software or hardware receivers that work with any monitoring software.
- Can send event messages to SIA DC-09 receivers.
- Connection supervision by polling to IP receiver every 10 seconds (or by user defined period).
- Backup channel, that will be used if connection with the primary channel is lost.
- When Protegus service is enabled, events are first delivered to CMS, and only then are sent to app users.

Works with protegus app:

- “Push” and special sound notifications informing about events.
- Remote system Arm/Disarm.
- Remote control of connected devices (lights, gates, ventilation systems, heating, sprinklers, etc.).
- Different user rights for administrator, installer and user.

Controllable outputs and inputs:

- 3 I/O, selectable type: NC, NO, EOL=2.2 kΩ

Quick setup:

- Settings can be saved to file and quickly written to other communicators.
- Two access levels for configuring the device for CMS administrator and for installer.
- Remote configuration and firmware updates.

Supported intrusion alarm panels:

Any alarm panel that has a landline dialer and supports dialing in Contact ID protocol and DTMF tones.

Power supply voltage	10 - 15 VDC
Current consumption	100 mA (on standby) Up to 250 mA (while sending data)
Ethernet connection	IEEE802.3, 10 Base-T, RJ45 socket
Connection to control panel	Via Telephone Communicator (TIP RING terminals)
Dual purpose terminals [IN/OUT]	3, can be set as either NC; NO; NC/EOL; NO/EOL; NC/DEOL; NO/DEOL (10 kΩ) type inputs or open collector (OC) type outputs with current up to 0,15 A, 30 VDC max. Expandable with iO series expanders
Transmission protocols	TRK, DC-09_2007, DC-09_2012, TL150
Message encryption	AES 128
Changing settings	With TrikdirConfig computer program remotely or locally via USB Mini-B port
Memory	Up to 60 messages
Operating environment	Temperature from -10 °C to 50 °C, relative humidity - up to 80% at +20 °C
Communicator dimensions	88 x 62 x 26 mm
Weight	0.08 kg

Designed to combine the best features of TRIKDIS security control panels, communicators and controllers.

FLEXi is a hybrid security control panel with on-board WiFi and Cellular or Ethernet connectivity. Unique feature set allows you to use this panel both in intrusion alarm and automation installations.

SECURITY CONTROL PANEL

Wi-Fi +4G

Ethernet +4G

Wi-Fi +2G

Wi-Fi +Ethernet

Wi-Fi

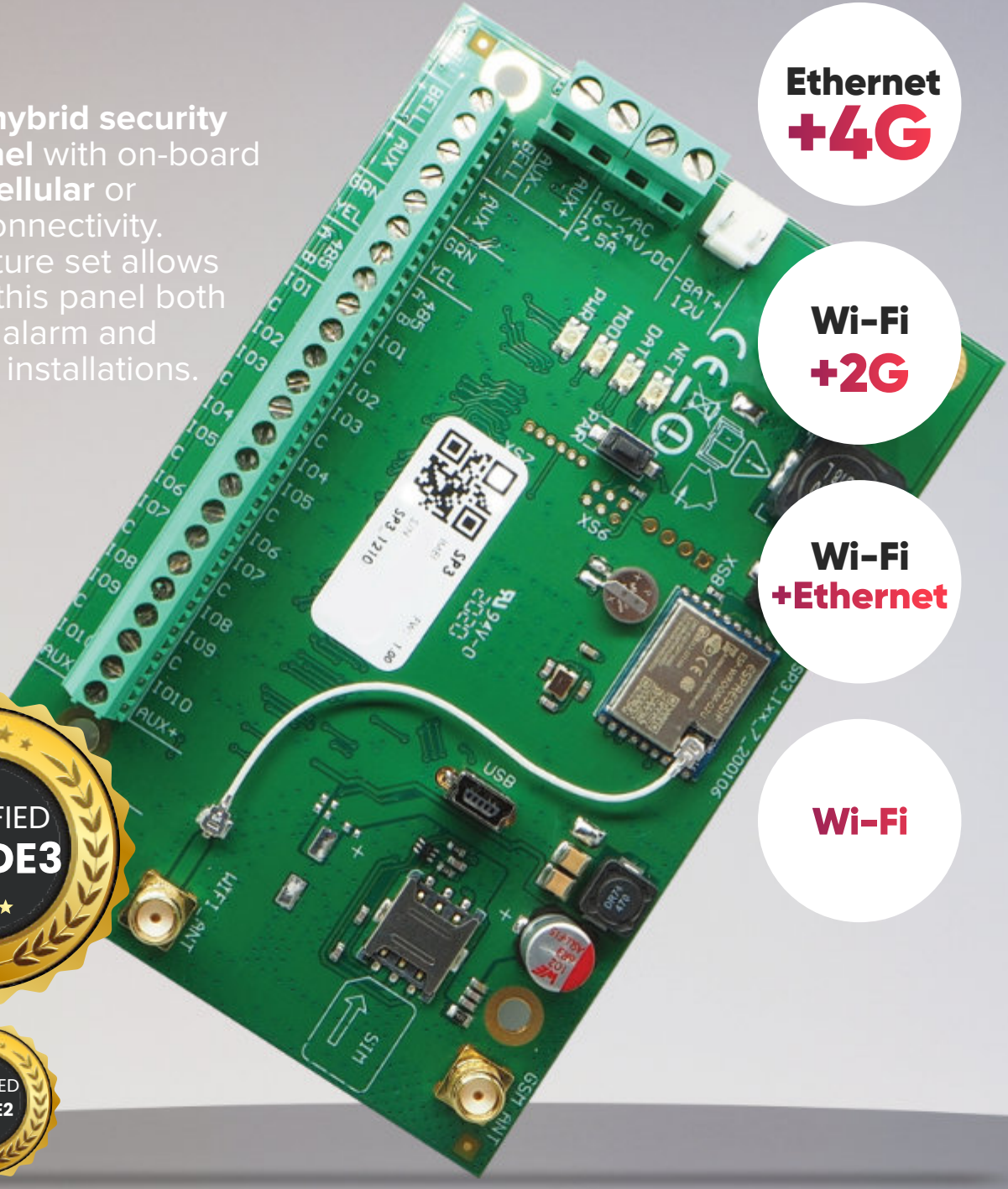

FLEXi SP3

Adaptable Security Panel

Modifications

Tailored to individual cases, different connection requirements, and **meets different user needs** so you will make a great solution every time.

Power supply	16-24 V, 2,5 A AC
Current consumption	Up to 50 mA (stand-by), Up to 200 mA (short-term, while sending)
WiFi frequency, protocol, encryption	2,4 GHz, 802.11 b/g/n, WPA, WPA2, WPA mixed
WiFi network configuration	DHCP or manual
SIM card	1, NANO size
GSM/GPRS modem	Quad-band
4G modem	4G (LTE-FDD) with migration to 3G (WCDMA) and 2G (GSM/EDGE) feature
Ethernet port	RJ-45 connector
Event transmission directions	- To main and backup receivers of 2 different security companies; - iOS/Android Protegus mobiliąsias programas; - To 8 mobile phones via SMS messages. - Calls to 8 mobile phones. Vocal event notification
Event transmission channels	2G or 4G, WiFi, LAN (with module E485), SMS, Voice call, VHF/UHF radio (with transmitter T16)
Programmable communication channel/direction priority	Yes
Message encryption	TRK AES 128, SIA IP AES 128 / Contact ID codes
Internal clock	Yes
Events log memory	1000 entries, oldest deleted automatically
User codes	40
Duress code	Yes
No. of partitions	8
No. of zones	10 (20 if set ATZ), expandable up to 32 with expanders
No. of PGM outputs	2 (12 if IO terminals are set as OUT) Expandable to 16 with expanders
No. of keypads	8
No. of RFID readers	2 (Wiegand 26/34)
No. of compatible temperature sensors	8
No. of compatible electronic (iButton) keys	40
Compatible wireless systems	Crow Shepherd, Freewave2 via extra add-on RF module
Operating environment	Temperature from -10 °C to +50 °C, relative humidity 80%, at +20 °C, no condensation

Make It Wireless

P ▲ R ▲ D O X



If you're looking for a security system that won't require any messy wiring, the FLEXi SP3 is a great option. It supports the Paradox RTX 3 module, which allows you to connect Paradox wireless equipment. This makes installation quick and easy, and ensures that your security system will be up and running in no time.



RF-SH WIRELESS EQUIPMENT RECEIVER

for Crow equipment



Wireless equipment receiver provides wireless connectivity between Trikdis control panels FLEXi SP3 or CG17 and wireless sensors from Crow. With RF-SH module FLEXi can easily connect to Shepherd and Freewave2 series wireless security sensors.



TRIKDIS
RF-SH

- RS485
- LEARN
- POWER

10-16V
0.25A Max

- < +DC
- < -DC
- < A RS485
- < B RS485

- No settings required**
- Compatible with Crow Shepherd and Freewave 2 WL**
- RS485 interface**

Honeywell

RF-HW WIRELESS EQUIPMENT RECEIVER

for Honeywell equipment

The RF-HW wireless transceiver is designed to work with FLEXi SP3 and Honeywell wireless equipment. The transceiver is easy to connect to the FLEXi SP3 control panel and ensures a reliable and secure connection. The transceiver can be used with a variety of Honeywell protocol-enabled equipment, such as wireless sensors, including door, window, motion sensors, keypads, and more.

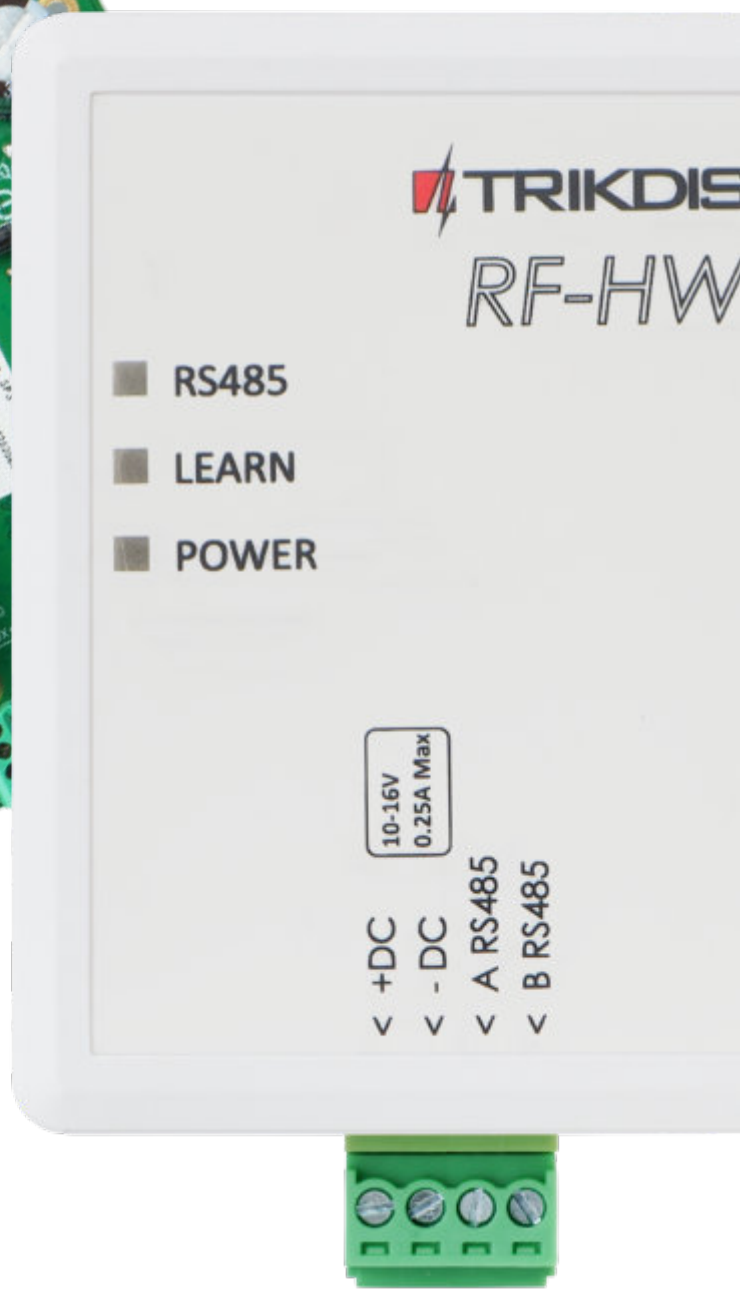

- No settings required**
- Compatible with Honeywell Home WL**
- RS485 interface**

FLEXi

KeyPad
SK LCD

Sleek minimalistic design keypad with LCD screen, designed for FLEXi SP3 control panel.

▼ **KEYPAD**





Sleek minimalistic design keypad with LCD screen, designed for FLEXi SP3 control panel. Backlit sensor touch buttons with tone. Multi-language support.

The FLEXi is a highly advanced, multifunction alarm control system, designed to flawlessly manage your security system at home or at business, protects you against burglary.

- White color
- LCD screen
- Indication for events in 32 zones
- 8 partitions
- Touch-sensitive keys
- Panic codes
- Adjustable brightness and sound
- Automatic dimming
- Temperature sensor
- Compatible with TRIKDIS control panel FLEXi SP3



SPECIFICATIONS ▼

Power supply	10-15 V DC
Power consumption	25-60mA
Dimensions	152x117x22 mm
Weight	230 g

GATE AUTOMATION CONTROLLER



FEATURES:

Easy installation – only insert a SIM and connect the controller to device you want to control.

One 1A relay and two PGM outputs to:

- Control any device;
- Full and partial control of gates, or opening only doors.

Remote control with:

- Protegus app (iOS, Android, Web);
- Phone call (cost-free, device rejects incoming calls);
- SMS messages.

Remote setup and administration – add users, and change settings with:

- TrikdisConfig;
- Protegus app;
- SMS commands.

Send events to security company receiver.



SPECIFICATIONS:

2G GSM modem frequencies	850 / 900 / 1800 / 1900 MHz
4G UMTS modem frequencies	LTE FDD: B1/B3/B7/B8/B20/B28A GSM: 900/1800MHz
Power supply voltage	9-32 V DC 12-24 V AC
Current consumption	100 mA
Inputs	2, selectable type: NC, NO, EOL=10 kΩ
Universal inputs/outputs	2, can be set either as input IN with type: NC, NO, EOL=10 kΩ, or output OUT (open collector (OC) 50 mA)
Output	1, relay, 1 A 30 V DC, 0,5 A 125 V AC
Unsent events memory	Up to 60 events
Event log memory	Up to 5000 events
Users who receive messages and have permission to control	7
Users who have permission to control	1000
Operating environment	Temperature from -10 °C to 50 °C, relative humidity - up to 80% at +20 °C
Communicator dimensions	88 x 62 x 26 mm
Weight	0.08 kg

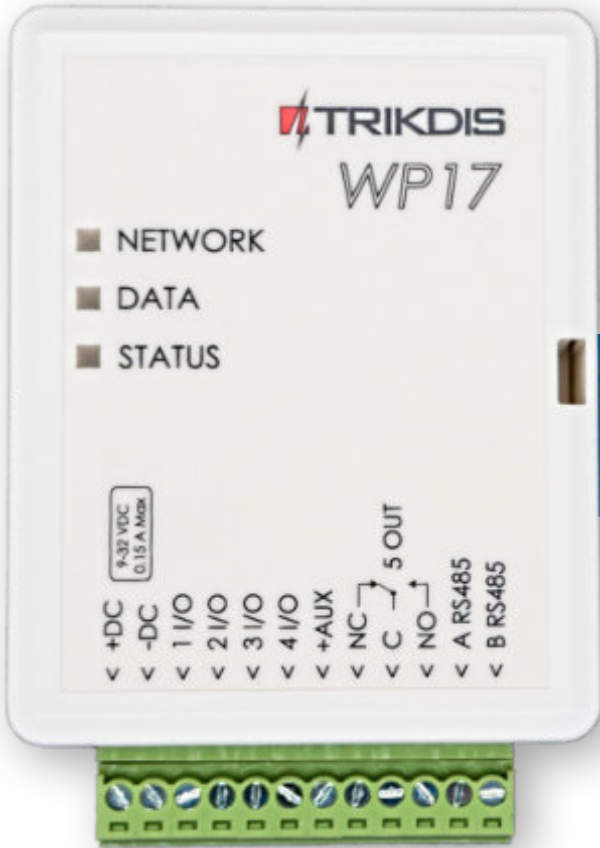

WI-FI

GATE AUTOMATION CONTROLLER

The Wi-Fi controller WP17 is designed for remote control of an automatic door (or other electrical equipment).

WP17 can be controlled with Protegus app. Up to 990 users.

Also can be used to set the user control schedule, set the counter, how many times the user can control the system. The controller can send messages about input and output activation and restores to the CMS (Central Monitoring Station) receiver and the Protegus app.



FEATURES

Remote control

- With Mobile application Protegus.

Messages for users

- Sends messages about events to the Protegus

Messages for the security company

- Sends event information in Contact ID codes to TRIKDIS software and hardware receivers, which work with any monitoring software.
- Can simultaneously send event messages to the receiver of the safety company and work with the Protegus
- If the connection with the main receiver is lost, the messages are automatically sent to a backup receiver.

Inputs and outputs

- 4 universal inputs/outputs. The mode of operation is set as either input (NO; NC; EOL) or output.
- 1 output (OUT) – relay.

Settings and installation

- Quick and easy installation.
- The addition of new users and deletion of existing users can be done with the Protegus app (when logged in with administrator rights), TrikdisConfig
- The device can be configured either by connecting a USB Mini-B cable or remotely with the TrikdisConfig
- Remote updating of firmware.



SPECIFICATIONS:

Power supply voltage	9-32 V DC
Current consumption	150 mA
Universal inputs/outputs	4, can be set either as input IN with type: NC, NO, EOL=10 kΩ, or output OUT (open collector (OC) 50 mA)
Output	1 pcs., relay, 1 A 30 V DC, 0,5 A 125 V AC
Connection to CMS	TCP/IP or UDP/IP via Wi-Fi
Event transmission protocol	TRK_TCP or TRK_UDP
Encryption key	6 symbol encryption key
Wi-Fi frequency	2,4 GHz
Wi-Fi protocol	802.11 b/g/n
Security mode	WPA, WPA2, WPA mixed
Network configuration type	DHCP or manual network configuration (using phone or laptop)
Unsent events memory	Up to 60 events
Event log memory	Up to 5000 events
Users who have permission to control	1000
Operating environment	Temperature from -10 °C to 50 °C, relative humidity - up to 80% at +20 °C
Communicator dimensions	88 x 62 x 26 mm
Weight	0.08 kg

RF-LoRa Transceiver

Range of operation
up to 5000 m.

▼ LORA EQUIPMENT RECEIVER RF-LORA



The RF-LORA wireless transceiver is designed to work with TRIKDIS LoRa wireless equipment.

The transceiver is easy to connect to the FLEXi SP3 control panel and ensures a reliable and secure connection. The transceiver can be used with a iO-LORA and iO8-LORA expanders.

LoRa (short for long range) is a spread spectrum modulation technique derived from chirp spread spectrum (CSS) technology. Semtech's LoRa is a long range, low power wireless platform that has become the de facto wireless platform of Internet of Things (IoT).

LoRa devices have amassed several hundred known uses cases for smart cities, homes and buildings, communities, metering, supply chain and logistics, agriculture, and more.

FEATURES

Communication:

- Line-of-sight wireless range up to 5000 m.
- One RF-LORA transceiver can be connected to the "FLEXi" SP3 control panel.

Connection:

- The RF-LORA transceiver is connected to the "FLEXi" SP3 control panel via the RS485 bus.

SPECIFICATIONS:

Power supply voltage	9-26 V DC
Current consumption	Up to 50 mA (stand-by) Up to 150 mA (short-term, while sending)
Transmission frequency	867-869 MHz
Modulation type	LoRa
Report encryption	Yes
Range in open space	5000 m
Operating environment	Temperature from -10 °C to 50 °C, relative humidity - up to 80% at +20 °C
Communicator dimensions	62 x 82 x 25 mm
Weight	0.08 kg

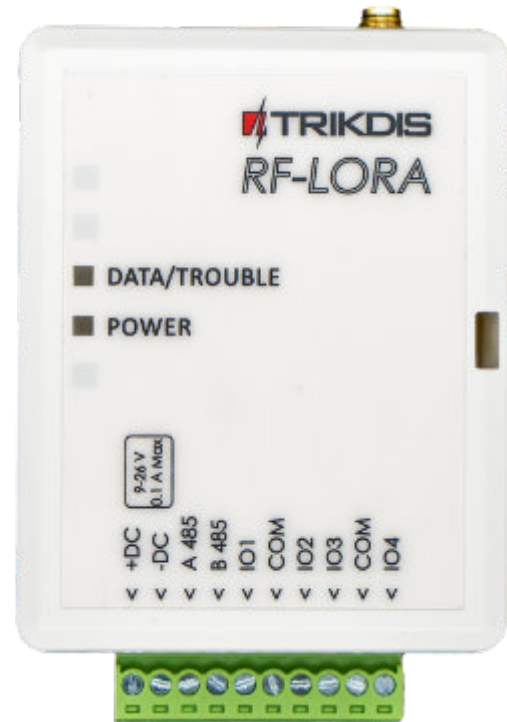

iO-LoRa expander

Range of operation up to 5000 m.

With integrated relay

iO-LORA is LoRa wireless expander that expands the number of inputs and outputs with RF-LORA module for FLEXi SP3 control panel using a two-way LoRa wireless connection. The operating range is up to 5000 m. It also has an integrated contact with a relay.



LoRa (short for long range) is a spread spectrum modulation technique derived from chirp spread spectrum (CSS) technology. Semtech's LoRa is a long range, low power wireless platform that has become the de facto wireless platform of Internet of Things (IoT).

LoRa devices have amassed several hundred known uses cases for smart cities, homes and buildings, communities, metering, supply chain and logistics, agriculture, and more.

FEATURES

Communication:

- Line-of-sight wireless range up to 5000 m.
- Up to 8 iO-LORA wireless expanders can be connected to the "FLEXi" SP3 control panel.

Inputs and outputs::

- Bus "1-Wire" is intended for connection of temperature sensors (up to 4 pcs.) and readers of contact ("iButton") keys.
- 1 input, of selectable type: NC, NO.
- 1 output (relay).

Connection:

- The iO-LORA wireless expander is connected to the "FLEXi" SP3 control panel via the RF-LORA transceiver.

SPECIFICATIONS:

Power supply voltage	9-26 V DC
Current consumption	Up to 50 mA (stand-by) Up to 150 mA (short-term, while sending)
Transmission frequency	867-869 MHz
Modulation type	LoRa
Report encryption	Yes
Range in open space	5000 m
Input	1, selectable type: NC, NO
Output	1, relay, 250 V AC, 4 A
Temperature sensor	4, Maxim®/Dallas® DS18S20, DS18B20
Operating environment	Temperature from -10 °C to 50 °C, relative humidity - up to 80% at +20 °C
Communicator dimensions	62 x 82 x 25 mm
Weight	0.08 kg



iO8-LoRa expander

Range of operation up to 5000 m.



8 I/O terminals

iO8-LORA is expander for FLEXi SP3 control panel and TRIKDIS LoRa series modules, it increase the number of inputs and outputs in a device.

LoRa (short for long range) is a spread spectrum modulation technique derived from chirp spread spectrum (CSS) technology. Semtech's LoRa is a long range, low power wireless platform that has become the de facto wireless platform of Internet of Things (IoT).

LoRa devices have amassed several hundred known uses cases for smart cities, homes and buildings, communities, metering, supply chain and logistics, agriculture, and more.

FEATURES

Communication:

- Line-of-sight wireless range up to 5000 m.
- Up to 8 iO8-LORA wireless expanders can be connected to the "FLEXi" SP3 control panel.

Inputs and outputs::

- 8 I/O terminals, each one can be set as an input (IN) or output (OUT). Input (IN) types: ATZ, EOL, NC, NO. Different value of resistors can be used in EOL and ATZ type circuits.

Connection:

- The iO-8-LORA wireless expander is connected to the "FLEXi" SP3 control panel via the RF-LORA transceiver.

SPECIFICATIONS:

Power supply voltage	9-26 V DC
Current consumption	Up to 50 mA (stand-by) Up to 150 mA (short-term, while sending)
Transmission frequency	867-869 MHz
Modulation type	LoRa
Report encryption	Yes
Range in open space	5000 m
Dual purpose terminals [I/O]	8, IN or OUT function selected during programming. When IN is selected, available types: NC, NO, EOL, EOL_T, 3EOL, ATZ, ATZ_T. When OUT is selected, the terminal becomes open collector (OC) type with up to 100 mA current
Operating environment	Temperature from -10 °C to 50 °C, relative humidity - up to 80% at +20 °C
Communicator dimensions	62 x 82 x 25 mm
Weight	0.08 kg

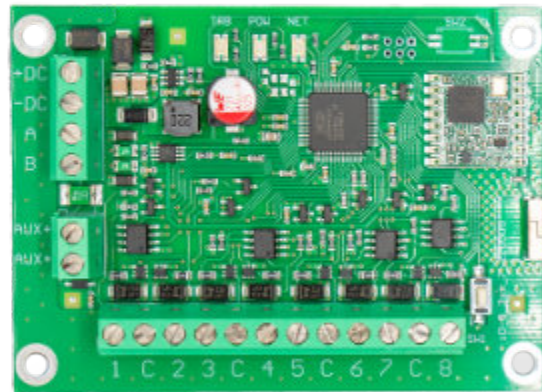



CELLULAR SECURITY CONTROL PANEL



Remote control

Install a simple security system that can be monitored and controlled remotely.



Various equipment

Control various equipment remotely (e.g. heating and ventilation systems, automatic gates).



Monitor temperature

Monitor temperature, water or fuel level, or other parameters.



Notifications

Notify users about events.



Notifications to the receiver

Send event notifications to the receiver of a security company.

Sends events to monitoring station receiver:

- Sends events to TRIKDIS software or hardware receivers that work with any monitoring software.
- Can send event messages to SIA DC-09 receivers.
- Connection supervision by polling to IP receiver every 30 seconds (or by user defined period).
- Backup channel that will be used if connection with the primary channel is lost.
- Events can be reported to CMS with SMS messages. SMS will be sent even if data connection stops working in the mobile operator network.
- With parallel communication channels events can be sent to two receivers at same time.
- When Protegus service is enabled, events are first delivered to CMS, and only then are sent to app users.

Works with Protegus app:

- “Push” and special sound notifications informing about events.
- Remote system Arm/Disarm.
- Remote control of connected devices (lights, gates, ventilation systems, heating, sprinklers, etc.).
- Remote temperature monitoring (with iO or iO-WL expanders).
- Different user rights for administrator, installer and user.
- Users can also be informed about events with SMS messages and phone calls.

Notifies users about events:

- Calls specified phone numbers (up to 8 users) and informs about events using recorded voice messages.
- Sends SMS messages about events.
- “Push” and special sound event notifications using the Protegus app.

Remote system and output control:

- Using Protegus app.
- Using contact (iButton) key reader.
- By calling the device’s phone number.
- Using SMS messages.
- Using an automatic “if...then” algorithm. E.g. when an input is enabled or the temperature exceeds a certain limit, an output will be turned on.

Supports these expanders:

- iO series wired or wireless expanders, which increase the number of inputs (IN) and outputs (OUT).
- GPS receiver (useful for protecting ATMs and vending machines).
- Fuel or water level sensor. For protecting gas tanks or monitoring water level.
- Backup power and charging of 12 V battery.

Inputs and outputs

- 1 input, 2 outputs and 3 double I/O terminals that can be set either as input (IN) or controllable output (OUT) terminals.
- One wire data bus (1-Wire) for connecting temperature sensors (up to 8) and a contact (iButton) key reader.
- Number of inputs (IN) or outputs (OUT) can be increased to 12 using iO series wired or wireless expanders.

Simple installation:

- Default settings for use either as a control panel or as communicator.
- Settings can be saved to file and quickly written to other devices.
- Configuration either using an USB cable or remotely using TrikdisConfig software.
- Two types of access levels (accounts), for the installer and for the administrator.

Parameter	Description
Dual purpose terminals [IN/OUT]	3, can be set as either NC, NO, EOL=10kΩ type inputs or open collector (OC) type outputs with current up to 100mA
Inputs [IN]	1, selectable type: NC, NO or EOL=10kΩ
Outputs [OUT]	2, open collector (OC) type, up to 1A of current
Number of areas	8
1-Wire data bus length [1 WIRE]	Up to 30 m
Compatible temperature sensors	Maxim®/Dallas® DS18S20, DS18B20
Maximum number of temperature sensors connected to the 1-Wire data bus	8
Compatible contact (iButton) keys [1 WIRE]	Maxim®/Dallas® DS1990A
Maximum number of contact (iButton) keys	12
RS485 data bus length	Up to 300m
Maximum number of devices connected to the RS485 data bus	8
Buffer memory capacity	60 events
Number of communication channels	2 (1st channel: main, backup; 2nd channel: Protegus)
Internal clock	Yes
Event reporting channels	GPRS or 3G, SMS, Voice call
Communication with CMS	TCP / IP or UDP / IP, or SMS
Communication protocols	TRK, encrypted DC-09_2007 or DC-09_2012
GSM/GPRS modem frequencies	850 / 900 / 1800 / 1900 MHz
3G modem frequencies	800 / 850 / 900 / 1900 / 2100 MHz
Power supply [AC / +DC]	16-24V DC or 16-18V AC
Current consumption	Up to 50mA (stand-by), Up to 200mA (short-term, transmitting)
Backup power supply [BAT]	12V lead -acid battery
Battery charge current	Up to 500mA
Power supply voltage and current for external devices [+12V]	12V DC, up to 1000mA
Operating environment	From -10 °C to + 50 °C, relative air humidity up to 70% at 0- +40 °C (no condensation)
Dimensions	113 x 70 x 25mm
Weight	0.10 kg

W485 WI-FI MODULE



Secure connection

Main WiFi channel, GPRS - backup.



Works with the Protegeus app

Users can remotely arm / disarm their alarm system and receive notifications about events.



Simple connection

No additional configuration.



Less use of data

Sends messages via Wi-Fi, mobile data traffic for messaging is not used.

W485 Wi-Fi module is an add-on to TRIKDIS communicators G16, G16T, control panel SP231 and radio transmitter T16, providing WiFi connectivity.

With communicators G16 and G16T it provides a transparent primary communication channel via WiFi. This allows to control the alarm system with communicator remotely via Protegeus app when it is connected via WiFi.

When you connect the W485 to the G16 / G16T, all the features of the communicator you use will remain:

- Transmission of events from Paradox, DSC, Texecom, Inetrlogix, Honeywell and other alarm panels to the CRA;
- Connection with Protegeus Cloud and Protegeus application;
- Remote control of Paradox, DSC, Texecom, Inetrlogix, Honeywell and other brands;
- Remote programming through the TrikdisConfig and all other functions.

Power supply	9-28 VDC
Current consumption	150 mA (in standby mode), Up to 200 mA (while sending data)
Compatible with	Trikdis communicator G16 / G16T Trikdis control panel SP231 Trikdis T16 radio transmitter
Wi-Fi frequency	2.4 GHz
Wi-Fi protocols	802.11 b/g/n
Type of Wi-Fi antenna	Internal
Security mode	WPA, WPA2, WPA mix
Network configuration type	DHCP or manual network configuration (using phone or laptop)
Operating environment	From -10 ° C to 50 ° C, relative humidity - up to 80% at +20 ° C
Dimensions	88 x 62 x 26 mm

E485

ETHERNET MODULE



Secure connection

Main Ethernet channel, GPRS - backup.



Works with the Protegeus app

Users can remotely arm / disarm their alarm system and receive notifications about events.



Simple connection

No additional configuration.



Less use of data

Sends messages via ethernet, mobile data traffic for messaging is not used.

The “Ethernet” **module E485** is compatible with the GSM communicators G16 and G16T (firmware from 1.32) and is designed to transmit data and control commands via the wired Internet network. By using the **E485** in conjunction with the G16 or G16T, messages are sent to the CMS (central monitoring station) via the wired internet network and in this case the mobile Internet is not used. When communication is interrupted on the wired internet network, messages are sent to the monitoring station via the mobile internet network.

E485 Module transmits complete information about events to the monitoring station receiver.

Connection

- Connection type: wired internet.

Settings and installation

- Quick and easy installation.

Communication

- Two primary connection channel and two secondary connection channel.
- Alternative sending of event logs to Protegeus app, which allows the user to monitor the security system remotely.
- The communicator uses Contact ID codes to transmit event messages.

Power supply	12-28 VDC
Current consumption	50 mA (stand-by) Up to 150 mA (transmitting)
Compatible with	Cellular communicator G16 and G16T (firmware 1.32), CG17, G17F, GV17, T16
Connection to CMS	TCP/IP or UDP/IP via LAN
Event transmission protocol	TRK_TCP or TRK_UDP
Event sending	In Contact ID codes
Encryption key	6 simbol encryption key
Ethernet PHY	IEEE802.3, 10-100BaseTX, Full-duplex, RJ45 port
Network configuration type	DHCP or manual network configuration (from the main managed device G16 or G16T)
Operating environment	From -10 ° C to +50 ° C, relative humidity - up to 80% at +20 ° C
Dimensions	88 x 62 x 26 mm

G17F CELLULAR COMMUNICATOR

FOR FIRE PANEL



Simple and fast to install communicator which will upgrade any fire alarm panel for event signaling via cellular network.

When input is triggered, communicator transmits event information to Alarm Receiving Centre (ARC). In addition, customers can be informed about fire alarm events in Protegus apps.

◀ GSM COMMUNICATOR (FOR FIRE PANEL)

Communications:

- One main communication channel
- Two back-up channels
- Connection control with ARC
- Event messages are transmitted in Contact ID codes
- Informing customers about events with:
 - Protegus apps
 - SMS messages

Configuration:

- Quick and easy installation
- Remote configuration and firmware updates

Inputs and outputs:

- 6 selectable type inputs: NC, NO, EOL (10kΩ).
- RS485 connection
- 3 input, 3 double purpose screw terminals for setting either input or output functionality
- Using iO series expanders it is possible to expand number of inputs up to 12
- Outputs can be controlled via:
 - Mobile/Web Protegus application or
 - SMS/Call

GSM modem frequencies	850 / 900 / 1800 / 1900 MHz
3G modem frequencies	800 / 850 / 900 / 1900 / 2100 MHz
LTE modem frequencies	700 / 800 / 900 / 1800 / 2100 / 2600 MHz
Power supply voltage	9-32 VDC
Current consumption	100 mA (standby) Up to 200 mA (transmitting)
Transmission protocols	TRK
Communication with ARC	TCP/IP or UDP/IP, SMS
Memory	Up to 60 messages
Inputs and outputs	3 inputs, 3 double purpose contacts for setting either input or output functionality Selectable type inputs: NC, NO, EOL (10kΩ)
Event transmission	Contact ID codes
Encryption key	6 symbols encryption key
Parameter configuration	Locally via USB port or remotely
Operating environment	Temperature from -10 °C to 50 °C, relative humidity – up to 80% at +20 °C
Communicator dimensions	77 x 62 x 25 mm
Weight	0.08 kg

iO8 INPUT AND OUTPUT EXPANDER

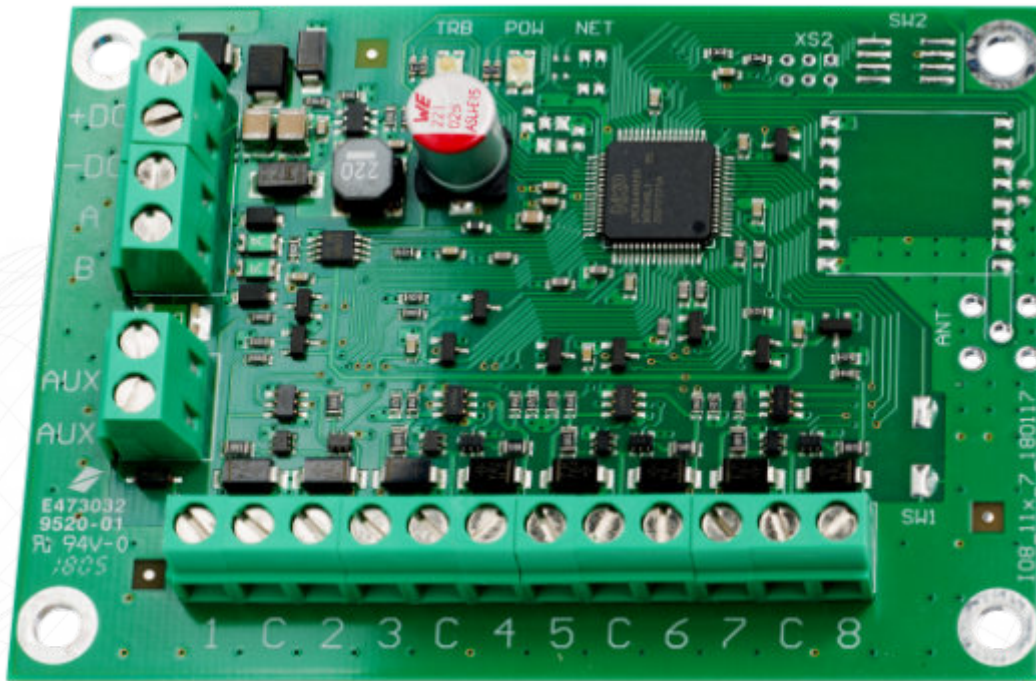

◀ INPUT AND OUTPUT EXPANDER

Increase the number of inputs and outputs in a compatible TRIKDIS device

iO-8 features:

- Eight contacts, which can be set to either input or output mode.
- Plug-and-play installation.
- Setup through the main TRIKDIS device.

iO-8 is compatible with these TRIKDIS devices:

- FLEXi SP3
- Controller CG17
- Communicator G16
- Communicator G16T
- Communicator G17F

Power supply voltage	10-18V DC
Current consumption	Up to 20mA
AUX output voltage	Up to 1A
IO number	8
Input type	NC, NO, EOL
Input voltage	Up to voltage of power supply
EOL nominal resistivity	2,2k Ω or 10k Ω (depending on main TRIKDIS device)
Output type	OC
Output voltage	0V-18V
Output current	Up to 100 mA
Operating environment	From -10 °C to +55 °C, with relative air humidity 80% when +20 °C

MODULE SF485

Designed to work with TRIKDIS communicators



When popular transmission to CMS not safe enough

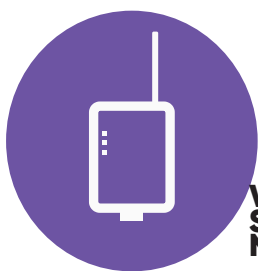

**VIA
SIGFOX
NETWORK**



**FOR
ANY ALARM
PANEL**



**WITH
TRIKDIS
COMMUNICATOR**

SF485 works as a secondary channel for security panel events transmission to Central Monitoring Station (CMS) or Protegus mobile app when the primary channel fails.



No settings required



Contact ID events



RS485 interface



Parameter	Description
Power supply voltage	10-18 V DC
Current consumption	Up to 15 mA (stand by) Up to 60 mA (short-term, transmitting)
Network	Sigfox
Region	RC1
Device uplink radiation class	0U*
Sigfox ready certificate	P_01B8_6C72_01
Event reporting protocol	Contact ID
Interface	RS485
Protection class	IP20
Operating environment	Temperature from -10 °C to +50 °C, relative humidity 80% at +20 °C, no condensation
Dimensions	92 x 62 x 26 mm
Weight	70 g



WORKS WITH
protequs
intelligent security & control





App to make your work smarter.

Meet better Protegeus.

You can manage module configurations from anywhere you are at any time.

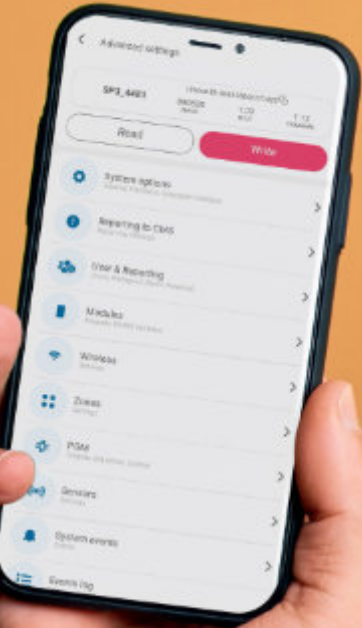

Connect directly to the module via Protegeus app!

Protegeus now has a new Advanced settings feature. It has been created with the aim to make everyday work easier by integrating all TrikdConfig features in one simple app.



Protegeus is a trusted and reliable security app, which helps you to protect premises. It provides you a smart security system, with clear status and easy to use interface.

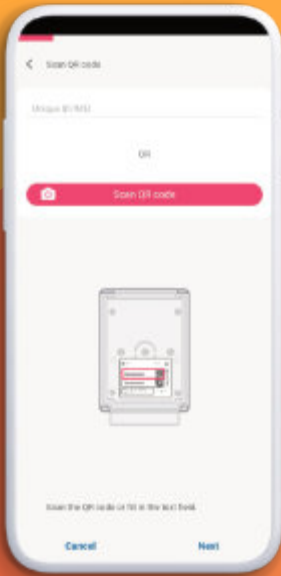

Add system in 60 seconds

With Protegeus you can set up a system in just 60 seconds, it takes just a few clicks. And quickly start managing the security system.



FLEXi SP3 all features

Our latest security control panel FLEXi SP3 has many features. And the new Protegeus enhance all of them because it was developed based on the FLEXi functionality.

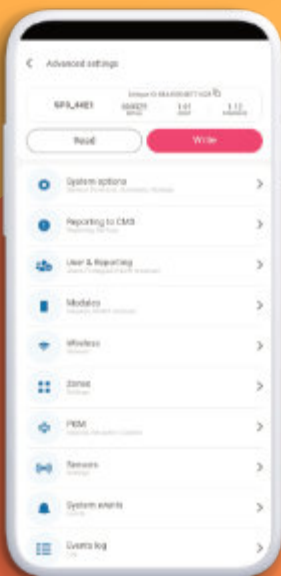

Advanced settings

TrikdisConfig in the app. The new Protegeus app makes it possible to configure your module from your phone, no more hassle with a laptop. Customize the system with Protegeus and make whatever changes you want.

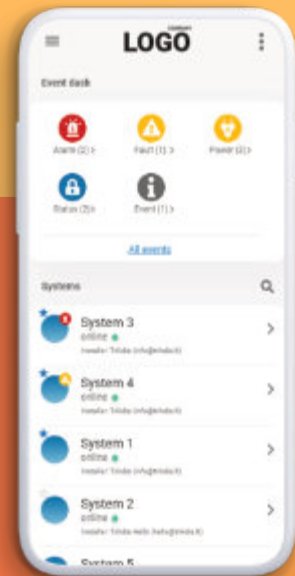

Company account

A company that installs Trikdix products and adds them to Protegeus may have a Protegeus Company account. This Protegeus Company account will allow the company to administer installed products that are added to their company.

You will be able to customize your brand colors, logos, and icons for your clients to recognize you. Also, change reaction types or names, and monitor all security systems on the dashboard.

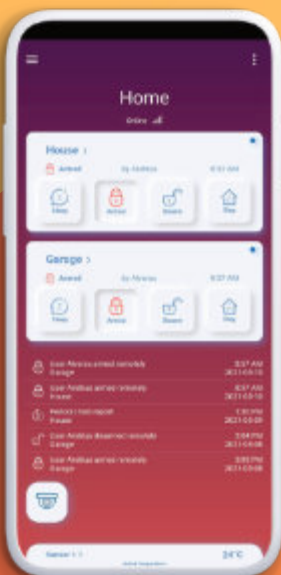

Direct read from module

All pre-configured settings will be visible as soon as you add the system to the application. Or configure on the go.

No more double configuration.



App to make your property safer.

Meet better Protegus.

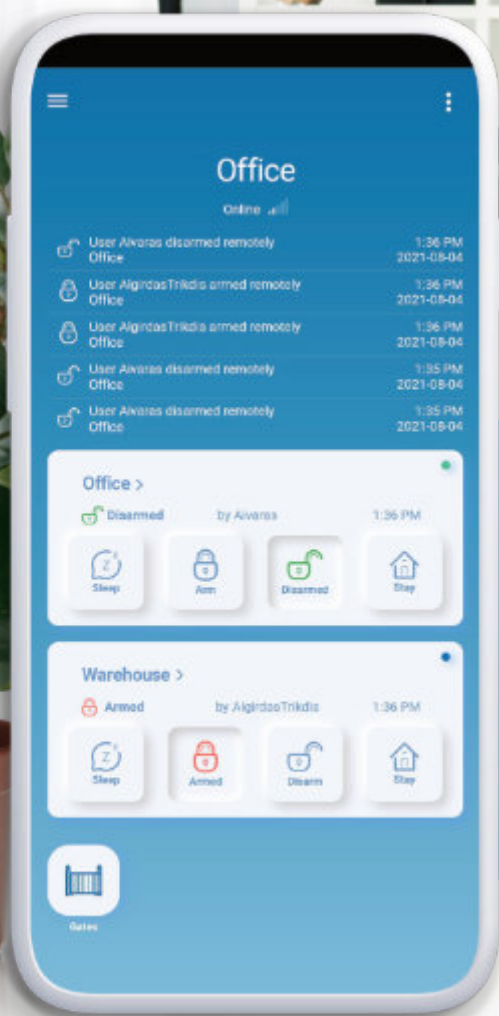

Protegus is a trusted and reliable security app, which helps you to protect your home and office premises. It provides you the best security system with clear status and easy to use interface. Protegus can be used as a stand alone or incorporated into your existing smart home system.

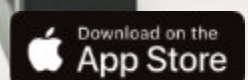

More info at trikdis.com

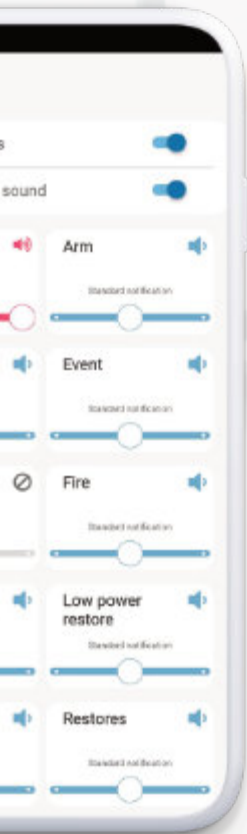
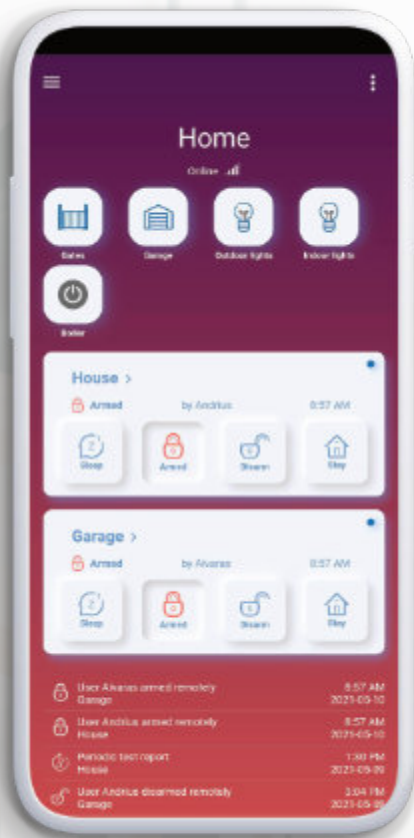
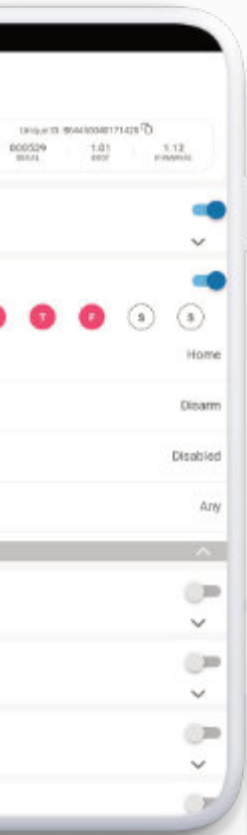
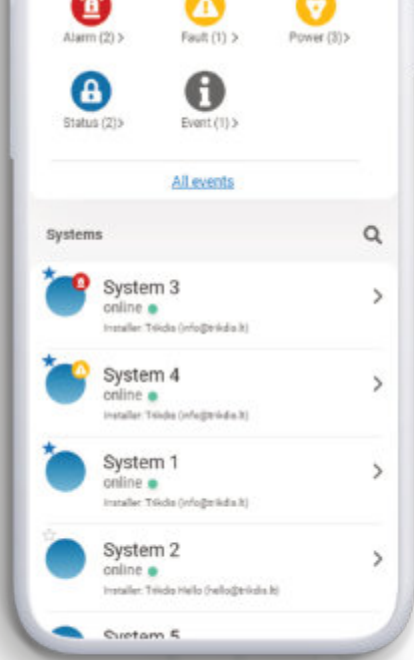

Customization

Use the Protegus app to customize your security system with your favourite colours and images. You can tailor the app to perfectly fit your lifestyle, creating a happy place that helps you start and end your day.



Better widgets

You can add widgets on your phone home screen and they are the same as in the app. You always see your status, and you always will be able to control the system without loading the app.



Company account

A company that installs Trikidis products and adds them to Protegus may have a Protegus Company account. This Protegus Company account will allow the company to administer installed products that are added to their company.

You will be able to customize your brand colors, logos, and icons for your clients to recognize you. Also, change reaction types or names, and monitor all security systems on the dashboard.



New interface

The technology is more user-friendly than the average smart security system, no more dead ends or hard to understand features.



FLEXi SP3 all features

Our latest security control panel FLEXi SP3 has many features. And the new Protegus enhance all of them because it was developed based on the FLEXi functionality.

App to make your home safer. Meet better Protegus.

Monitor your home security system, control it remotely, and get real-time notifications.

Protegus is a home monitoring app that provides peace of mind by both securing and monitoring your property. Once activated, it records and sends you real-time alerts if an intruder breaks in, nearby emergency situations, and live video streams from your house when things get interesting. Linking to a mobile app means you can take action from anywhere in the world. Protect what matters most from the comfort of wherever life takes you.

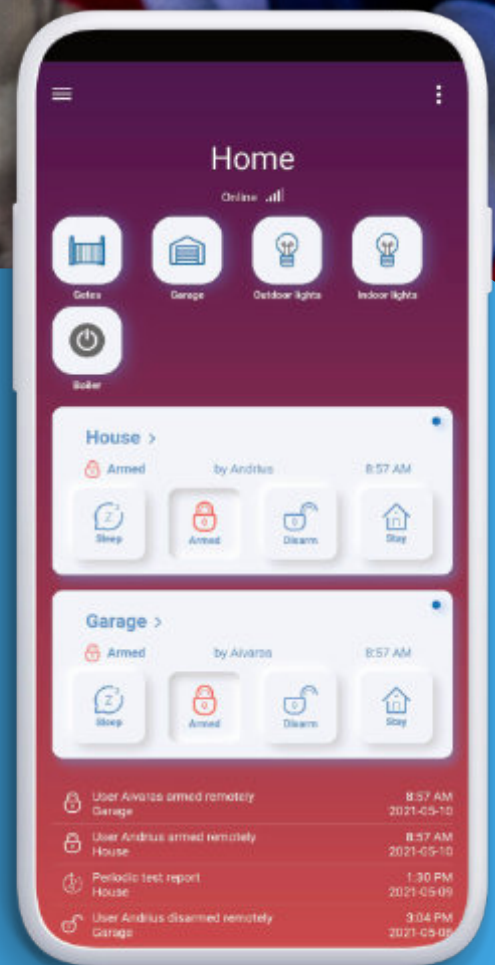

 **protegus** v2



Thermostat control

You'll never need a wall mount thermostat again! Set your desired comfort temperature for room then Protegus takes care of the rest. Wherever you are, you can always make any adjustments and check system status.

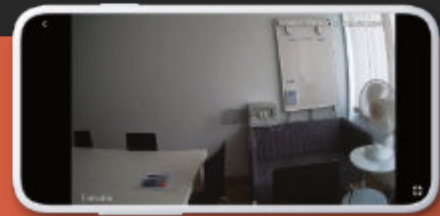

IP cameras

The Protegus app connects with all of cameras in the market with RTSP link to make scaling your smart home security system as simple as can be.

Don't miss a thing

Know immediately when someone's unlocks doors or disables security system. You can easily administrate the users, give them access or remove from the system.

Security & alarm

Enable or disable your security system through the app. You can also view the current status of your alarm, even when you're out and about. If your system detects a danger you'll be notified immediately.

Water leak? Fire?

Detect potential dangers such as a water leak or fire. Your system will inform you via Protegus immediately so you can take action before it turns into a costly problem.

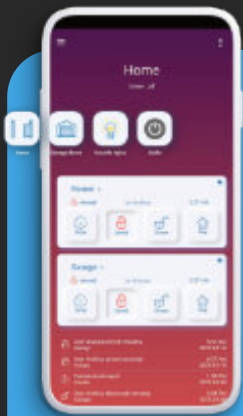

Garage/gates

Control your garage doors or electric gates from the Protegus App. You can also check status of a door when you're not home for extra peace of mind.

Company account

Administrate your clients in the app

A company that installs Trikdís products and adds them to Protegus may have a Protegus Company account. This Protegus Company account will allow the company to administer installed products that are added to Custom Protegus App.

Coming soon

Make sure your home is always secure.

Download the Protegus app to manage your security system. Download the app now on your Android or iOS device.

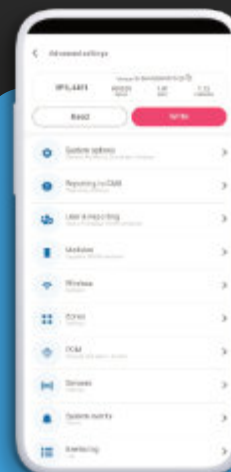

Advanced settings

Feel like an advance Trikdís user or installer? The new Protegus app makes it possible to configure your security settings from your phone, no more hassle with a laptop. Customize your app with whatever changes you want.

Cloud



End User

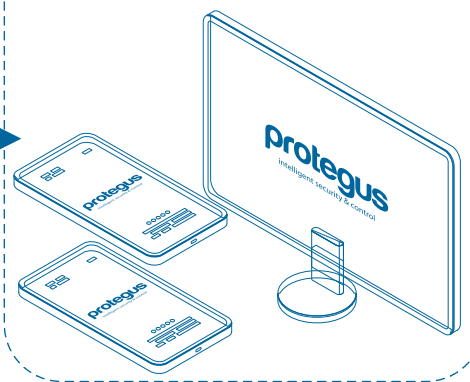

App for Any Alarm Panel

Universal Communicators



Any Security Panel

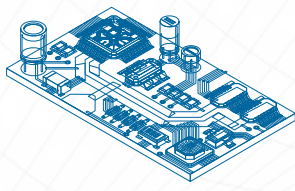

Alarm Monitoring Software



(((VHF/UHF)))

LAN

(((2G/3G/4G)))

Alarm Reception Center

Full Alarm System

Cellular Control Panels



(((2G/4G)))

Any Other Monitoring Software

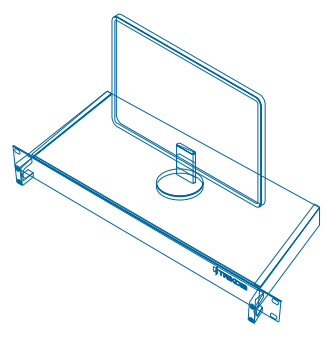

Software & Hardware receivers for the Central Alarm Receiver

IPCOM
Windows



RL14



IPCOM
Linux



	IPcom Windows	RL14	IPcom Linux
IP receiver	✓	✓	✓
Possibility of having multiple virtual receivers		✓	✓
Receiving via RS232		✓	3 RS232 configurable ports
SMS modem receiver, SMPP	Optional / GM14	Optional / GM14	
LAN IP output	✓	multiple	multiple
Output via RS232	✓	✓	3 RS232 configurable ports
Remote configuration of E16T, G16x and SPx series communicators over IP		✓	✓
Remote control of PGM outputs of G16x communicators		✓	✓
Display of module version, software version and IMEI or MAC address	✓	✓	✓
Removing all objects from the object list with a button		✓	✓
2 IP addresses can be used to receive		✓	
Relay event messages to PROTEGUS		✓	✓
IPcom process control (Watchdog)		✓	✓
PING for communication control		✓	✓
Module Message Tracking	✓	+ filtration	+ filtration
Object list export to CSV file		✓	✓
Filter for radio messages		✓	✓
Monas 3 protocol (for radio systems)		✓	✓
Rack mount box		✓	✓

EVERY NOTE MATTERS

EVERY NOTE MATTERS

EVERY NOTE MATTERS

RELIABLE ADAPTABILITY TO THE NEW SECURITY SYSTEMS

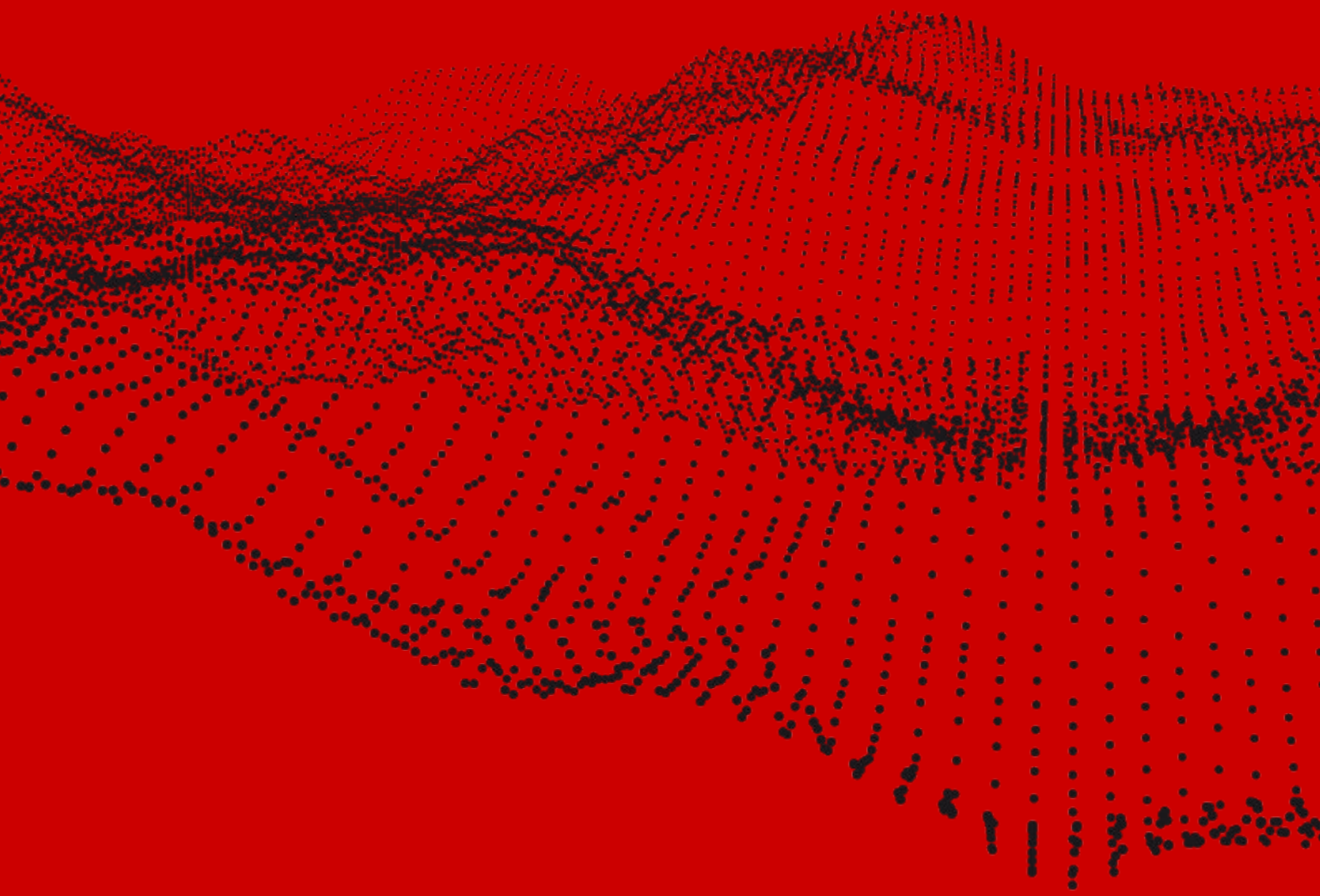

Address: Draugystės g. 17, LT-51229 Kaunas, Lithuania
Tel. +370 37 408040
Email: info@trikdis.lt

www.trikdis.com

