

YB-100

Bolt electric cu actiune magnetica, monitorizare si senzor

DESCRIERE

Bolt electric de inalta siguranta YB-100 cu actiune magnetica, monitorizare si senzor. Poate fi utilizat in sistemele de control acces. Se monteaza aplicat sau incastrat pe usi din lemn, metal, termopan, sticla si usi anti-foc.

CARACTERISTICI

- Fail-safe (deschis fara alimentare)
- Fire de monitorizare stare usa
- Protectie impotriva variatiilor de tensiune
- Protectie la curent invers (MOV)
- Blocare automata la inchiderea usii (senzor magnetic)
- Potrivit pentru usi de lemn, sticla, metal
- Compatibil cu usi care se deschid in ambele directii
- Certificate: CE, MA
- Testat la 500000 de deschideri
- Accesorii: ABK-500, ABK-600, ABK-600AL, ABK-700

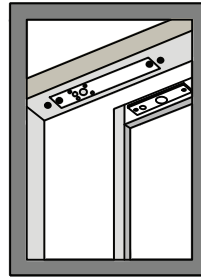

Standard

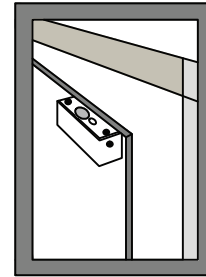

Usa din sticla fara toc

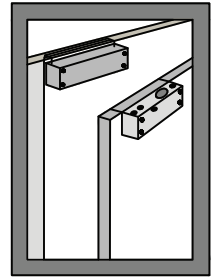

Usa din sticla fara toc

SPECIFICATII

- Tensiune de alimentare: 12Vcc, 120mA - stand-by, 900mA - in actionare
- Temperatura de functionare: -10°C ~ 55°C
- Dimensiuni bolt: L205mm x W35mm x H41mm
- Dimensiuni contraplaca: L90mm x W25mm x H2mm
- Dimensiuni corp bolt: lungime - 16mm, diametru - 16mm
- Forta de retinere: 800Kg
- Distanța maxima de inductie magnetica: 8mm
- Material: inox si duraluminiu
- Greutate: 700g
- Garantie: 3 ani

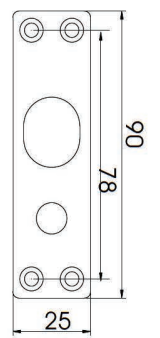
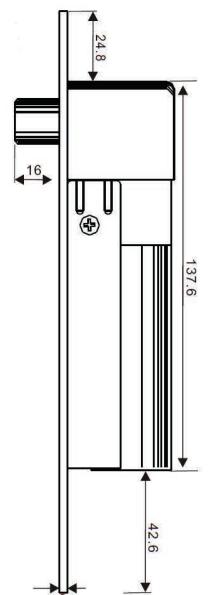
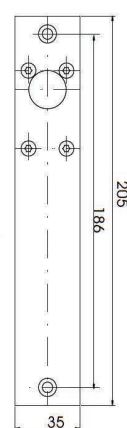
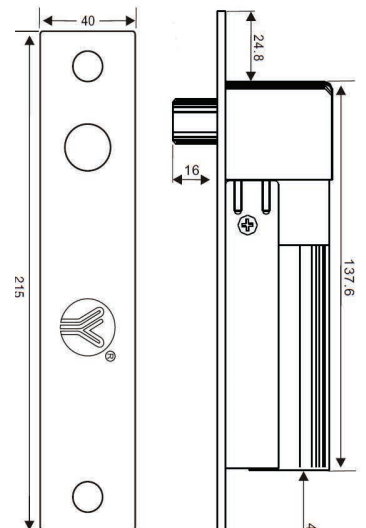

SCHEMA ELECTRICA

