

Physical Specifications

Part Number: AGM TED12285
 Length: 165 ± 2 mm (6.53 inches)
 Width: 175 ± 2 mm (6.89 inches)
 Height: 125 ± 2 mm (4.92 inches)
 Weight: ~ 7.9kg (17.41 lbs)

Standard case material is flame retardant to (UL94) HBO.
 The TED Batteries range provide an extremely reliable and versatile valve regulated lead acid battery. Their unique construction and sealing techniques ensures that no electrolyte leakage can occur, and provides safe and effective operation in any orientation, and meets all requirements of the International Air Transport Association Dangerous Goods Regulations to allow transportation by air.



Specifications

Terminal Type: Standard T12 (M5) or any suitable terminal (at customer request)

Design Floating Life 20°C (68°F): 9 Years

Maxim Discharge Current: 440A/5sec.

Internal Resistance: Approximative 13mΩ

Cycle Use: Initial Charging Current Less Than 8.40A • Voltage 14.4÷14.8 at 25°C (77°F) • Temperature Coefficient -30mV/°C
 Standby Use: No Limit on Initial Charging Current Voltage 13.5÷13.8V at 25°C (77°F) • Temperature Coefficient -20mV/°C
 Capacity Affected by Temperature 40°C (104°F) 103% 25°C (77°F) 100% 0°C (32°F) 86%

Self Discharge: TED Batteries may be stored for up to 6 months at 25°C (77°F) and than refresh charge is required. For higher temperatures, the time interval will be shorter.

Rated Capacity

| | | |
|---------------|------|----------------------|
| 29.0 Ah/1.45A | 20hr | 1.80V/cell 25°C/77°F |
| 27.0 Ah/2.70A | 10hr | 1.80V/cell 25°C/77°F |
| 24.7 Ah/4.95A | 5hr | 1.75V/cell 25°C/77°F |
| 22.2 Ah/7.42A | 3hr | 1.75V/cell 25°C/77°F |
| 18.3 Ah/18.3A | 1hr | 1.60V/cell 25°C/77°F |

Discharge Characteristics

| |
|------------------------------------|
| Operating Temperature Range |
| Charge: 0°C÷40°C (5°F÷104°F) |
| Storage: -15°C÷40°C (5°F÷104°F) |
| Nominal: 25°C±3°C (77°F±5°F) |
| Discharge: -15°C÷50°C (5°F÷122°F) |

T12 Terminal

Unit: mm [inches]

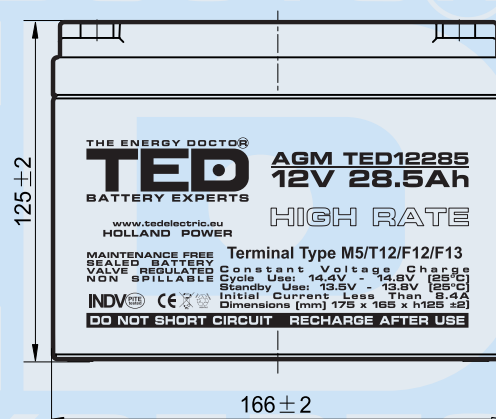
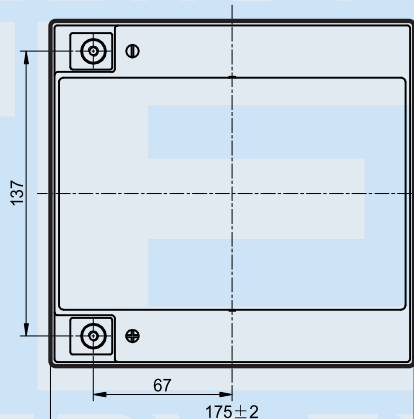
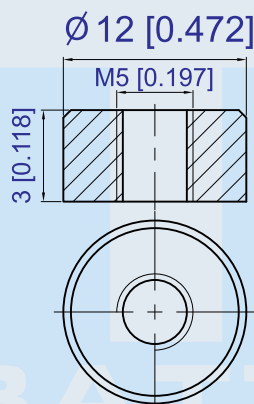

Constant Current Discharge (Amperes) at 25°C

| F.V/Time | 5MIN | 10MIN | 15MIN | 30MIN | 1HR | 2HR | 3HR | 4HR | 5HR | 8HR | 10HR | 20HR |
|----------|--------|-------|-------|-------|-------|-------|-------|-------|-------|-------|-------|-------|
| 1.60V | 105.46 | 68.78 | 50.74 | 29.36 | 16.97 | 10.54 | 7.660 | 6.100 | 5.149 | 3.441 | 2.802 | 1.458 |
| 1.65V | 101.65 | 66.73 | 49.41 | 28.72 | 16.65 | 10.38 | 7.559 | 6.024 | 5.090 | 3.406 | 2.776 | 1.446 |
| 1.70V | 96.70 | 64.04 | 47.66 | 27.87 | 16.24 | 10.18 | 7.423 | 5.923 | 5.011 | 3.360 | 2.740 | 1.431 |
| 1.75V | 90.33 | 60.56 | 45.39 | 26.75 | 15.69 | 9.907 | 7.243 | 5.789 | 4.906 | 3.298 | 2.693 | 1.410 |
| 1.80V | 82.30 | 56.12 | 42.46 | 25.31 | 14.97 | 9.550 | 7.006 | 5.613 | 4.766 | 3.217 | 2.631 | 1.382 |
| 1.85V | 72.42 | 50.56 | 38.77 | 23.46 | 14.05 | 9.086 | 6.697 | 5.382 | 4.584 | 3.109 | 2.548 | 1.346 |

Constant Power Discharge (Watts) at 25°C

| F.V/Time | 5MIN | 10MIN | 15MIN | 30MIN | 1HR | 2HR | 3HR | 4HR | 5HR | 8HR | 10HR | 20HR |
|----------|-------|-------|-------|-------|-------|-------|-------|-------|-------|------|------|------|
| 1.60V | 181.5 | 118.7 | 90.04 | 54.14 | 32.20 | 20.27 | 14.85 | 11.89 | 10.07 | 6.82 | 5.59 | 2.91 |
| 1.65V | 179.6 | 118.2 | 89.52 | 53.74 | 31.94 | 20.12 | 14.74 | 11.80 | 10.01 | 6.77 | 5.55 | 2.90 |
| 1.70V | 172.8 | 114.7 | 87.11 | 52.44 | 31.25 | 19.78 | 14.51 | 11.63 | 9.87 | 6.69 | 5.48 | 2.87 |
| 1.75V | 164.3 | 110.4 | 84.16 | 50.85 | 30.35 | 19.35 | 14.22 | 11.41 | 9.70 | 6.58 | 5.39 | 2.83 |
| 1.80V | 152.3 | 104.1 | 79.84 | 48.59 | 29.10 | 18.74 | 13.81 | 11.10 | 9.46 | 6.43 | 5.28 | 2.78 |
| 1.85V | 136.4 | 95.45 | 73.93 | 45.49 | 27.51 | 17.93 | 13.26 | 10.68 | 9.13 | 6.23 | 5.12 | 2.71 |

Discharge Characteristics

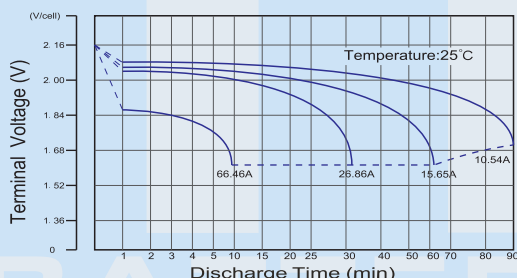

Float Charging Characteristics

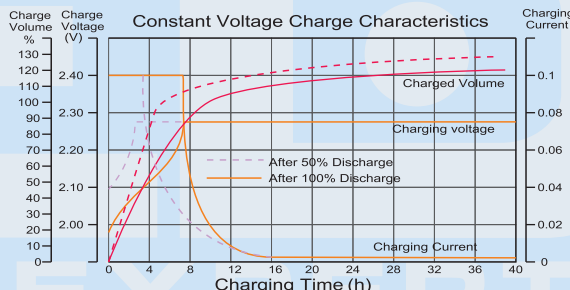

Temperature Effects in Relation to Battery Capacity

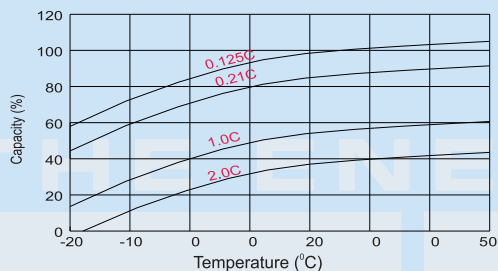

Effect of Temperature on Long Term Float Life

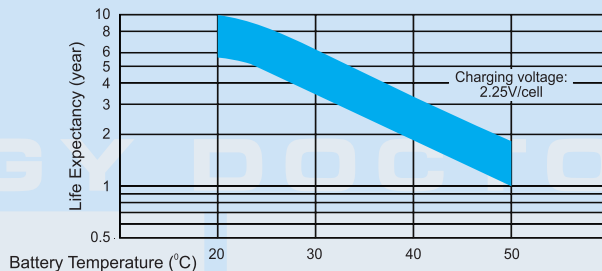

Cycle Life in Relation to Depth of Discharge

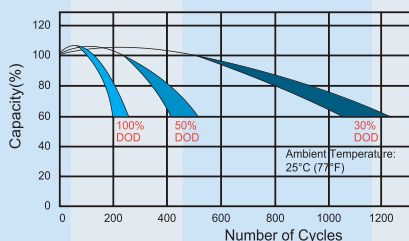

Testing condition
 Discharging current 0.17C (FV 1.7V/cell);
 Charging current 0.25C max, voltage 2.45V/cell;
 Charging volume: 125% of discharged capacity.

Self Discharge Characteristics

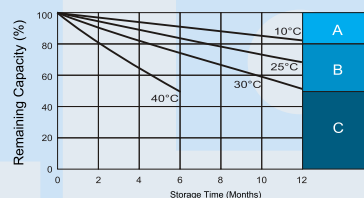

- A** No supplementary charge required (Carry out supplementary charge before use if 100% capacity is required.)
- B** Supplementary charge required before use. Optional charging way as below:
 1. Charged for above 3 days at limited current 0.25CA and constant voltage 2.25V/cell.
 2. Charged for above 20 hours at limited current 0.25CA and constant voltage 2.45V/cell.
 3. Charged for 8-10 hours at limited current 0.05CA.
- C** Supplementary charge may offset fail to recover the capacity. The battery should never be left standing till this is reached.