

EMC TEST REPORT For CE

Test Report No. : KES-E1-18T0032-R1

Date of Issue : May. 15, 2019

Product name : Network Camera

Model/Type No. : LND-6030R

Variant Model : LND-6020R, LND-6010R

Applicant : Hanwha Techwin Co., Ltd.

Applicant Address : 6, Pangyo-ro 319 Beon-gil, Bundang-gu, Seongnam-si,
Gyeonggi-do, 13488, KOREA

Manufacturer : 1. Hanwha Techwin (Tianjin) Co.,Ltd.
2. HANWHA TECHWIN SECURITY VIETNAM CO.,LTD.
3. D-TECH CO.,LTD.

Manufacturer Address : 1. No.11 Weiliu Rd, Micro-Electronic Industrial Park, TEDA, Tianjin,
300385, People's Republic of China
2. Lot O-2, Que Vo Industrial Zone extended area,
Nam Son commune, Bac Ninh city, Bac Ninh province, Vietnam
3. 173-25, Saneop-ro, Gwonseon-gu, Suwon-si, Gyeonggi-do,
Korea (Suwon Industrial Complex)

Date of Receipt : Dec. 21, 2017

Test date : Dec. 27, 2017 ~ Dec. 31, 2017

Test Results : **In Compliance** **Not in Compliance**

Tested by

Dong Il, Lee
EMC Test Engineer

Reviewed by

Dong-Hun, Jang
EMC Technical Manager

This test report is not related to KOLAS.



KES Co., Ltd.

3701, 40, Simin-daero 365beon-gil,
Dongan-gu, Anyang-si, Gyeonggi-do, 14057, Korea
Tel: +82-31-425-6200 / Fax: +82-31-424-0450
www.kes.co.kr

Test report No.:
KES-E1-18T0032-R1
Page (2) of (60)

REPORT REVISION HISTORY

Date	Test Report No.	Revision History
Jan. 08, 2018	KES-E1-18T0032	Issued
May. 15, 2019	KES-E1-18T0032-R1	Re-issue due to manufacturer change

This report shall not be reproduced except in full, without the written approval of KES Co., Ltd. This document May be altered or revised by KES Co., Ltd. personnel only, and shall be noted in the revision section of the document. Any alteration of this document not carried out by KES Co., Ltd. will constitute fraud and shall nullify the document.

This report shall not be reproduced except in full, without the written approval of KES Co., Ltd.
The results shown in this test report refer only to the sample(s) tested unless otherwise stated.
The authenticity of the test report, contact shchoi@kes.co.kr



TABLE OF CONTENTS

1.0	General Product Description	4
1.1	Test Voltage & Frequency	6
1.2	Variant Model Differences	6
1.3	Device Modifications	6
1.4	Equipment Under Test	6
1.5	Support Equipments	6
1.6	External I/O Cabling	7
1.7	E.U.T Operating Mode(s)	7
1.8	Configuration	8
1.9	Remarks when standards applied	9
1.10	Calibration Details of Equipment Used for Measurement	9
1.11	Test Facility	9
1.12	Laboratory Accreditations and Listings	9
2.0	Test Regulations	10
2.1	Conducted Emissions at Mains Power Ports	12
2.2	Conducted Emissions at Telecommunication Ports	13
2.3	Radiated Electric Field Emissions(Below 1 GHz)	14
2.4	Radiated Electric Field Emissions(Above 1 GHz)	15
2.5	Harmonic Current Emissions	16
2.6	Voltage Fluctuations and Flicker	17
3.0	Criteria for compliance	18
3.1	Electrostatic Discharge	20
3.2	Radiated Electric Field Immunity	24
3.3	Electrical Fast Transients/Bursts	27
3.4	Surge Transients	29
3.5	Conducted Disturbance	32
3.6	Voltage Dips and Short Interruptions	34
APPENDIX A – TEST DATA		36
Conducted Emissions at Mains Power Ports		36
Conducted Emissions at Telecommunication Ports		38
Radiated Electric Field Emissions(Below 1 GHz)		40
Radiated Electric Field Emissions(Above 1 GHz)		41
Harmonic Current Emissions and Voltage Fluctuations and Flicker		42
Test Setup Photos and Configuration		45
Conducted Voltage Emissions		45
Conducted Telecommunication Emissions		46
Radiated Electric Field Emissions(Below 1 GHz)		47
Radiated Electric Field Emissions(Above 1 GHz)		48
Harmonic Current Emissions and Voltage Fluctuations and Flicker		49
Electrostatic Discharge		50
Radiated Electric Field Immunity		50
Electrical Fast Transients/Bursts		51
Surge Transients		52
Conducted Disturbance		53
Voltage Dips and Short Interruptions		54
EUT External Photographs		55
EUT Internal Photographs		56

This report shall not be reproduced except in full, without the written approval of KES Co., Ltd.
The results shown in this test report refer only to the sample(s) tested unless otherwise stated.
The authenticity of the test report, contact shchoi@kes.co.kr

1.0 General Product Description

Main Specifications of E.U.T are:

Video	
Imaging Device	1/2.9" 2.19M CMOS
Total Pixels	2,000(H) x 1,121(V)
Effective Pixels	1,984(H) x 1,105(V)
Scanning System	Progressive
Min. Illumination	Color : 0.18Lux (1/30sec, F2.0), 0.003Lux (2sec, F2.0) B/W : 0Lux (IR LED on)
Lens	
Focal Length (Zoom Ratio)	6mm
Max. Aperture Ratio	F 2.0
Angular Field of View	H : 51° / V : 29° / D : 58°
Min. Object Distance	0.5m(1.64ft)
Lens Type	Fixed
Mount Type	Board type
Pan / Tilt / Rotate	
Pan / Tilt / Rotate Range	0~350° / 0~67° / 0~355°
Operational	
IR Viewable Length	20m
Camera Title	Off / On (Displayed up to 15 characters)
Day & Night	Auto(ICR) / Color / B/W / Schedule
Backlight Compensation	Off / BLC / WDR
Wide Dynamic Range	120dB
Contrast Enhancement	SSDR(Off / On)
Digital Noise Reduction	SSNR(Off / On)
Motion Detection	Off / On (4ea rectangular zones)
Privacy Masking	Off / On (6ea rectangular zones)
Gain Control	Off / Low / Middle / High
White Balance	ATW / AWC / Manual / Indoor / Outdoor
LDC(Lens distortion correction)	On/Off (5 levels with Min/Max)
Electronic Shutter Speed	Minimum / Maximum / Anti flicker
Flip / Mirror	Flip / Mirror / Hallway view
Intelligent Video Analytics	Motion Detection, Tampering
Alarm Triggers	Motion detection, Tampering Detection, SD card error
Alarm Events	File upload via FTP and E-Mail Local storage recording at Event Notification via E-Mail
Network	
Ethernet	RJ-45 (10/100BASE-T)
Video Compression Format	H.264, MJPEG
Resolution	1920x1080 / 1280x1024 / 1280x960 / 1280x720 / 1024x768 / 800x600 / 800x448 / 720x576 / 640x480 / 640x360 / 320x240

This report shall not be reproduced except in full, without the written approval of KES Co., Ltd.
The results shown in this test report refer only to the sample(s) tested unless otherwise stated.
The authenticity of the test report, contact shchoi@kes.co.kr



KES Co., Ltd.

3701, 40, Simin-daero 365beon-gil,
 Dongan-gu, Anyang-si, Gyeonggi-do, 14057, Korea
 Tel: +82-31-425-6200 / Fax: +82-31-424-0450
 www.kes.co.kr

Test report No.:
 KES-E1-18T0032-R1
 Page (5) of (60)

Max. Framerate	H.264 : Max 30fps at all resolutions MJPEG : Max.1fps at 1920x1080/1280x1024/1280x720/1024x768, Max. 15fps at other resolution
WiseStreamII	Support
Video Quality Ajustment	H.264/MJPEG : Target Bitrate Level Control
Bitrate control method	H.264 : CBR or VBR, MJPEG : VBR
Streaming Capability	Multiple streaming(up to 3 profiles)
Audio I/O	-
Audio Compression Format	-
Audio Communication	-
IP	IPv4, IPv6
Protocol	TCP/IP, UDP/IP, RTP(UDP), RTP(TCP), RTCP,RTSP, NTP, HTTP, HTTPS, SSL/TLS, DHCP, PPPoE, FTP, SMTP, ICMP, IGMP, SNMPv1/v2c/v3(MIB-2), ARP, DNS, DDNS, QoS, PIM-SM, UPnP, Bonjour
Security	HTTPS(SSL) Login Authentication, Digest Login Authentication IP Address Filtering, User access Log, 802.1X Authentication(EAP-TLS, EAP-LEAP)
Streaming Method	Unicast / Multicast
Max. User Access	6 users at Unicast Mode
Edge storage	Micro SD/SDHC/SDXC Max 32G - Motion images recorded in the SD memory card can be downloaded - Manual recording at Local PC
Application Programming Inter	ONVIF Profile S, G SUNAPI(HTTP API)
Webpage Language	English, French, German, Spanish, Italian, Chinese, Korean, Russian, Japanese, Swedish, Denish, Portuguese, Turkish, Polish, Czech, Rumanian, Serbian, Dutch, Croatia, Hungary, Greek, Finnish, Norwegian
Web Viewer	Supported OS : Windows 7, 8.1, 10, Mac OS X 10.10, 10.11, 10.12 Non-plugin Webviewer - Supported Browser : Google Chrome 63, MS Edge 41, Mozilla Firefox 57 (Window 64bit only), Apple Safari 11 (Mac OS X only) Plug-in Webviewer Supported Browser : MS Explore 11
Central Management Software	SmartViewer, SSM
Environmental	
Operating Temperature / Humi	-10°C ~ +55°C / Less than 90% RH
Storage Temperature / Humidi	-30°C ~ +60°C (-22°F ~ +140°F) / Less than 90% RH
Electrical	
Input Voltage / Current	PoE(IEEE802.3af, Class3)
Power Consumption	6.5W
Mechanical	
Color / Material	White / Plastic
Dimension (WxHxD)	Ø 110.0mm(4.33") x 86.0(3.39")mm
Weight	230g(0.51lb)

This report shall not be reproduced except in full, without the written approval of KES Co., Ltd.
 The results shown in this test report refer only to the sample(s) tested unless otherwise stated.
 The authenticity of the test report, contact shchoi@kes.co.kr



1.1 Test Voltage & Frequency

Unless indicated otherwise on the individual data sheet or test results, the test voltage and frequency was as indicated below.

Voltage 230Vac 100 Vac 24 Vac 12 Vdc PoE
Frequency 50 Hz 60 Hz Hz

1.2 Variant Model Differences

Lens magnification difference

1.3 Device Modifications

Not applicable

1.4 Equipment Under Test

Description	Model Number	Serial Number	Manufacturer	Remarks
Network Camera	LND-6030R	-	Hanwha Techwin (Tianjin) Co.,Ltd.	E.U.T

1.5 Support Equipments

Description	Model Number	Serial Number	Manufacturer	Remarks
PoE Adaptor	ANY4805C-LT1	10H300002	ANY ELECTRONICS CO., LTD	-
Notebook	NT630Z5J	JK9091EF400142M	SAMSUNG ELECTRONICS CO., LTD.	-
Notebook AC/DC Adaptor	A13-040N2A	CN60BA4400313A DON843KO2OO	Chicony Power Technology (suzhou)Co., Ltd.	-
Micro SD Card	-	-	SanDisk	-



1.6 External I/O Cabling

Start		END		Cable Spec.	
Description	I/O Port	Description	I/O Port	Length	Shield
Network Camera (E.U.T)	RJ-45	PoE Adaptor	RJ-45	3.0	U
PoE Adaptor	RJ-45	Notebook	RJ-45	3.0	U
Network Camera (E.U.T)	Micro SD Slot	Micro SD Card	Micro SD Slot	-	-

* Unshielded=U, Shielded=S

1.7 E.U.T Operating Mode(s)

Test Mode	operating
PoE	E.U.T Monitoring, Ping Test

E.U.T Test operating S/W		
Name	Version	Manufacture Company
Webviewer	-	Hanwha Techwin Co., Ltd.

1.8 Configuration

■ AC Main
□ DC Main

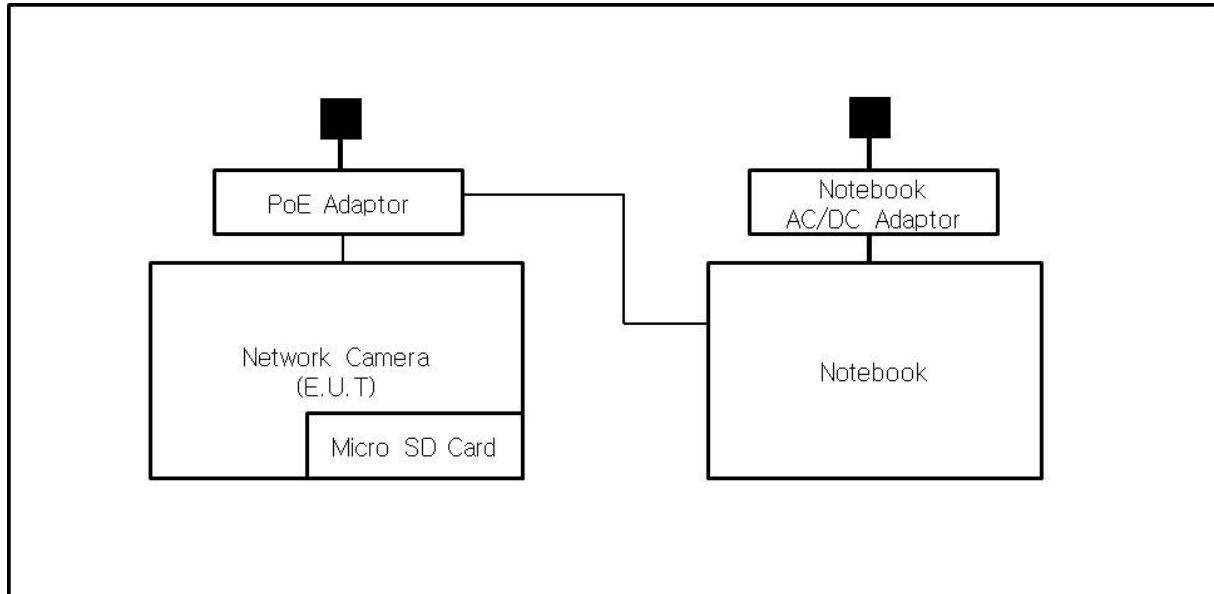

1.9 Remarks when standards applied

N/A







1.10 Calibration Details of Equipment Used for Measurement

Test equipment and test accessories are calibrated on regular basis. The maximum time between calibrations is one year or what is recommended by the manufacturer, whichever is less.

1.11 Test Facility

The measurement facility is located at 473-21 Gayeo-ro, Yeosu-si, Gyeonggi-do, 12658, Korea. The sites are constructed in conformance with the requirements of ANSI C63.4:2014 and CISPR 16-1-4:2012

1.12 Laboratory Accreditations and Listings

Country	Agency	Scope of Accreditation	Logo
KOREA	RRA	EMI (3 m & 10 m Semi-Anechoic Chamber , 10 m Open Area and conducted test site) EMS (ESD, RS, EFT/Burst, Surge, CS, Magnetic, Dips and interruptions)	 KR0100
International	KOLAS	EMI (3 m & 10 m Semi-Anechoic Chamber , and conducted test site) EMS (ESD, RS, EFT/Burst, Surge, CS, Magnetic, Dips and interruptions)	 KT489
USA	FCC	3 m & 10 m Semi-Anechoic Chamber, 10 m Open Area and Conducted test site to perform FCC Part 15/18 measurements.	 KR0100
Canada	ISED	3 m & 10 m Semi-Anechoic Chamber and Conducted test site	 23298-1
JAPAN	VCCI	Mains Ports Conducted Interference Measurement, Telecommunication Ports Conducted Disturbance Measurement and Radiation 10 meter site, Facility for measuring radiated disturbance above 1 GHz	 R-4308, C-4798, T-2311, G-914
Europe	TÜV SÜD	EMI (3 m & 10 m Semi-Anechoic Chamber , 10 m Open Area and conducted test site) EMS (ESD, RS, EFT/Burst, Surge, CS, Magnetic, Dips and interruptions)	 CARAT 17 07 01633 001

This report shall not be reproduced except in full, without the written approval of KES Co., Ltd.
The results shown in this test report refer only to the sample(s) tested unless otherwise stated.
The authenticity of the test report, contact shchoi@kes.co.kr

2.0 Test Regulations

The emissions tests were performed according to following regulations:

EMC – Directive 2014/30/EU

EN 61000-6-3:2011

EN 61000-6-1:2007

EN 61000-6-4:2007 +A1:2011

EN 61000-6-2:2005

EN 55011:2007 +A1:2010

Group 1

Group 2

Class A

Class B

EN 55014-1:2006 +A2:2011

EN 55014-2:1997 +A2:2008

EN 55015:2013

EN 61547:2009

EN 55032:2012/AC:2013

Class A

Class B

EN 55024:2010 +A1:2015

EN 50130-4:2011

EN 61000-3-2:2014

EN 61000-3-3:2013

EN 61326-1:2013



-
- | | | |
|---|----------------------------------|----------------------------------|
| <input type="checkbox"/> VCCI V-3 / 2015.04 | <input type="checkbox"/> Class A | <input type="checkbox"/> Class B |
| <input type="checkbox"/> AS/NZS CISPR22:2009 +A1:2010 | <input type="checkbox"/> Class A | <input type="checkbox"/> Class B |
| <input type="checkbox"/> 47 CFR Part 15, Subpart B | | |
| <input type="checkbox"/> CISPR 22:2009 +A1:2010 | <input type="checkbox"/> Class A | <input type="checkbox"/> Class B |
| <input type="checkbox"/> ANSI C63.4-2009 | | |
| <input type="checkbox"/> IC Regulation ICES-003 : 2016 | | |
| <input type="checkbox"/> CAN/CSA CISPR 22-10 | <input type="checkbox"/> Class A | <input type="checkbox"/> Class B |
| <input type="checkbox"/> ANSI C63.4-2014 | | |
| <input type="checkbox"/> RE- Directive 2014/53/EU | | |
| <input type="checkbox"/> EN 301 489-1 V1.9.2 | | |
| <input type="checkbox"/> Equipment for fixed use | | |
| <input type="checkbox"/> Equipment for vehicular use | | |
| <input type="checkbox"/> Equipment for portable use | | |
| <input type="checkbox"/> EN 301 489-3 V1.6.1 | | |
| <input type="checkbox"/> EN 301 489-17 V2.2.1 | | |
| <input type="checkbox"/> EN 60945:2002 | | |



2.1 Conducted Emissions at Mains Power Ports

Test Date

N/A

Test Location

Electro wave Shieldroom #6

Test Equipment

Used	Description	Model Number	Manufacturer	Serial Number	Cal. Due
<input type="checkbox"/>	EMI Test S/W	EMC32	R & S	9.12.00	-
<input type="checkbox"/>	EMI TEST RECEIVER	ESR3	R & S	101781	04, 27, 2018
<input type="checkbox"/>	LISN	ENV216	R & S	101787	01, 11, 2018
<input type="checkbox"/>	LISN	ESH2-Z5	R & S	100450	04, 27, 2018
<input type="checkbox"/>	PULSE LIMITER	ESH3-Z2	R & S	101915	11, 27, 2018
<input type="checkbox"/>	LISN	NNBM8124	SCHWARZBECK	8124-1002	08, 07, 2018
<input type="checkbox"/>	LISN	NNBM8124	SCHWARZBECK	8124-1003	08, 07, 2018

Test Conditions

Temperature:

°C

Relative Humidity:

% R.H.

.

Frequency Range of Measurement

150 kHz to 30 MHz

Instrument Settings

IF Band Width: 9 kHz

Test Results

The requirements are:

- PASS
- NOT PASS
- NOT APPLICABLE

Remarks

N/A

2.2 Conducted Emissions at Telecommunication Ports

Test Date

Dec. 27, 2017

Test Location

Electro wave Shieldroom #6

Test Equipment

Used	Description	Model Number	Manufacturer	Serial Number	Cal. Due
<input checked="" type="checkbox"/>	EMI Test S/W	EMC32	R & S	9.12.00	-
<input checked="" type="checkbox"/>	EMI TEST RECEIVER	ESR3	R & S	101781	04, 27, 2018
<input checked="" type="checkbox"/>	LISN	ENV216	R & S	101787	01, 11, 2018
<input checked="" type="checkbox"/>	LISN	ESH2-Z5	R & S	100450	04, 27, 2018
<input checked="" type="checkbox"/>	PULSE LIMITER	ESH3-Z2	R & S	101915	11, 27, 2018
<input checked="" type="checkbox"/>	8-WIRE ISN CAT3,5	ENY81	R & S	100174	01, 11, 2018
<input type="checkbox"/>	8-WIRE ISN CAT6	ENY81-CAT6	R & S	101665	01, 11, 2018
<input type="checkbox"/>	ISN	ISN S8	SCHWARZBECK	ISN-S8-0019	05, 12, 2018
<input type="checkbox"/>	CDN	CDNS502A	TESEQ	40431	01, 11, 2018

Test Conditions

Temperature: 22,0 °C
Relative Humidity: 41,2 % R.H.

Frequency Range of Measurement

150 kHz to 30 MHz

Instrument Settings

IF Band Width: 9 kHz

Test Results

The requirements are:

- PASS
- NOT PASS
- NOT APPLICABLE

Remarks

See Appendix A for test data.

This report shall not be reproduced except in full, without the written approval of KES Co., Ltd.
The results shown in this test report refer only to the sample(s) tested unless otherwise stated.
The authenticity of the test report, contact shchoi@kes.co.kr

2.3 Radiated Electric Field Emissions(Below 1 GHz)

Test Date

Dec. 29, 2017

Test Location

OPEN AREA TEST SITE #2 SEMI ANECHOIC CHAMBER #4(10m)

Test Equipment

Used	Description	Model Number	Manufacturer	Serial Number	Cal. Due
<input checked="" type="checkbox"/>	EMI Test S/W	EP5/RE	TOYO Corporation	6.0.0	-
<input checked="" type="checkbox"/>	EMI TEST RECEIVER	ESU26	R & S	100551	04, 18, 2018
<input checked="" type="checkbox"/>	AMPLIFIER	SCU 01	R & S	100603	11, 27, 2018
<input checked="" type="checkbox"/>	TRILOG-BROADBAND ANTENNA	VULB9163	Schwarzbeck	716	11, 28, 2018

Test Conditions

Temperature: 21,3 °C
Relative Humidity: 41,8 % R.H.

Frequency Range of Measurement

30 MHz to 1 GHz

Instrument Settings

IF Band Width: 120 kHz

Test Results

The requirements are:

- PASS
 NOT PASS
 NOT APPLICABLE

Remarks

See Appendix A for test data.

2.4 Radiated Electric Field Emissions(Above 1 GHz)

Test Date

Dec. 28, 2017

Test Location

SEMI ANECHOIC CHAMBER #3

Test Equipment

Used	Description	Model Number	Manufacturer	Serial Number	Cal. Due
<input checked="" type="checkbox"/>	EMI Test S/W	EP5/RE	TOYO Corporation	6.0.0	-
<input checked="" type="checkbox"/>	EMI TEST RECEIVER	ESR7	R & S	101190	08, 07, 2018
<input checked="" type="checkbox"/>	PREAMPLIFIER	8449B	AGILENT	3008A01967	05, 31, 2018
<input type="checkbox"/>	ATTENUATOR	8491A	HP	32173	03, 24, 2018
<input checked="" type="checkbox"/>	DOUBLE RIDGED HORN ANTENNA	SAS-571	A.H.SYSTEM,INC	781	05, 02, 2019

Test Conditions

Temperature: 22,3 °C
Relative Humidity: 43,0 % R.H.

Frequency Range of Measurement

1 GHz to 6 GHz

Instrument Settings

IF Band Width: 1 MHz

Test Results

The requirements are:

- PASS
- NOT PASS
- NOT APPLICABLE

Remarks

See Appendix A for test data.

3.0 Criteria for compliance

Criteria for compliance was based on the following guidelines:
EN 50130-4:2011 Alarm systems-Part 4: Electromagnetic compatibility Product family
standard: Immunity requirements for components of fire, intruder and social alarm systems

The variety and the diversity of the apparatus within the scope of this document makes it

difficult to define precise criteria for the evaluation of the immunity test results.

If as a result of the application of the tests defined in this standard, the apparatus becomes dangerous or unsafe then the apparatus shall be deemed to have failed the test.

A functional description and a definition of performance by the manufacture and noted in the test

report, based on the following criteria:

Electrostatic discharge

There shall be no damage, malfunction or change of status due to the conditioning.
Flickering of an indicator during the application of discharge is permissible, providing that is no residual change in the EUT or any change in outputs, which could be interpreted by associated equipment as a change.

Radiated electromagnetic fields

There shall be no damage, malfunction or change of status due to the conditioning.

Flickering of an indicator during the application of discharge is permissible, providing which could be interpreted by associated equipment as a change, and no such

Flickering of indicators occurs at a field strength of 3 V/m.

For components of CCTV systems, where the picture is allowed at 10 V/m, providing.

(a) there is no permanent damage or change to EUT

(e.g. no corruption of memory or changes to programmable setting etc.)

(b) at 3 V/m, any deterioration of the picture is so minor that the system could still be used; and

(c) there is no observable deterioration of the picture at 1 V/m.

Fast transient burst / slow high energy voltage surge

There shall be no damage, malfunction or change of status due to the conditioning.
Flickering of an indicator during the application of discharge is permissible, providing
That there is no residual is permissible, providing that there is no residual change in the EUT or
any
change in outputs, which could be interpreted by associated equipment as a change.

Conducted RF immunity

There shall be no damage, malfunction or change of status due to the conditioning.
Flickering of an indicator during the application of discharge is permissible, providing
That there is no residual is permissible, providing that there is no residual change in the EUT or
any
change in outputs, which could be interpreted by associated equipment as a change,
and no such flickering of indicators oeuvres at $U = 130 \text{ dB}\mu\text{V}$.
For component of CCTV systems, where the status is monitored by observing the TV picture,
then deterioration of the picture is allowed at $U = 140 \text{ dB}\mu\text{V}$, providing:
(a) there is no permanent damage or change to the EUT
(e.g. no corruption of memory or changes to programmable settings etc.)
(b) at $U = 130 \text{ dB}\mu\text{V}$, any deterioration of the picture is so minor that the system could
still be used; and
(c) there in no observable deterioration of the picture at $U = 120 \text{ dB}\mu\text{V}$.

Voltage dip/interruption / Voltage variation

There shall be no damage, malfunction or change of status due to the conditioning.
Flickering of an indicator during the conditioning is permissible, providing that there is no
residual
change in the EUT or any change in outputs, which could be interpreted by associated
equipment
as a change. The EUT shall meet the acceptance criteria for the functional test, after the
conditioning.



3.1 Electrostatic Discharge

Reference Standard

EN 61000-4-2:2009

Test Date

Dec. 31, 2017

Test Location

EMS-ESD: Electro wave Shieldroom #7

Test Equipment

Used	Description	Model Number	Manufacturer	Serial Number	Cal. Due
<input checked="" type="checkbox"/>	ESD SIMULATOR	ESS-2000	Noise Ken	ESS01Z0454	10, 11, 2018
<input checked="" type="checkbox"/>	HCP	-	KES	-	-
<input checked="" type="checkbox"/>	VCP	-	KES	-	-

Test Conditions

Temperature: 21,6 °C
Relative Humidity: 41,9 % R.H.
Atmospheric Pressure: 101,0 kPa

This report shall not be reproduced except in full, without the written approval of KES Co., Ltd.
The results shown in this test report refer only to the sample(s) tested unless otherwise stated.
The authenticity of the test report, contact shchoi@kes.co.kr



Test Specifications

Discharge Factor: ≥ 1 s

Discharge Impedance: 330 ohm / 150 pF

Kind of Discharge: Air, Contact (direct and indirect)

Polarity: Positive and Negative

Number of Discharge: 10 at all locations for Air discharge
10 at all locations for Contact discharge

Discharge Voltage:	Contact	Air	HCP	VCP
	<input type="checkbox"/> 2 kV	<input checked="" type="checkbox"/> 2 kV	<input type="checkbox"/> 2 kV	<input type="checkbox"/> 2 kV
	<input type="checkbox"/> 4 kV	<input checked="" type="checkbox"/> 4 kV	<input type="checkbox"/> 4 kV	<input type="checkbox"/> 4 kV
	<input checked="" type="checkbox"/> 6 kV	<input type="checkbox"/> 6 kV	<input checked="" type="checkbox"/> 6 kV	<input checked="" type="checkbox"/> 6 kV
	<input type="checkbox"/> 8 kV	<input checked="" type="checkbox"/> 8 kV	<input type="checkbox"/> 8 kV	<input type="checkbox"/> 8 kV
	<input type="checkbox"/> 15 kV	<input type="checkbox"/> 15 kV	<input type="checkbox"/> 15 kV	<input type="checkbox"/> 15 kV

Notes: HCP: Horizontal coupling plane

VCP: Vertical coupling plane

Required Performance Criteria: Complied

Location of Discharge:

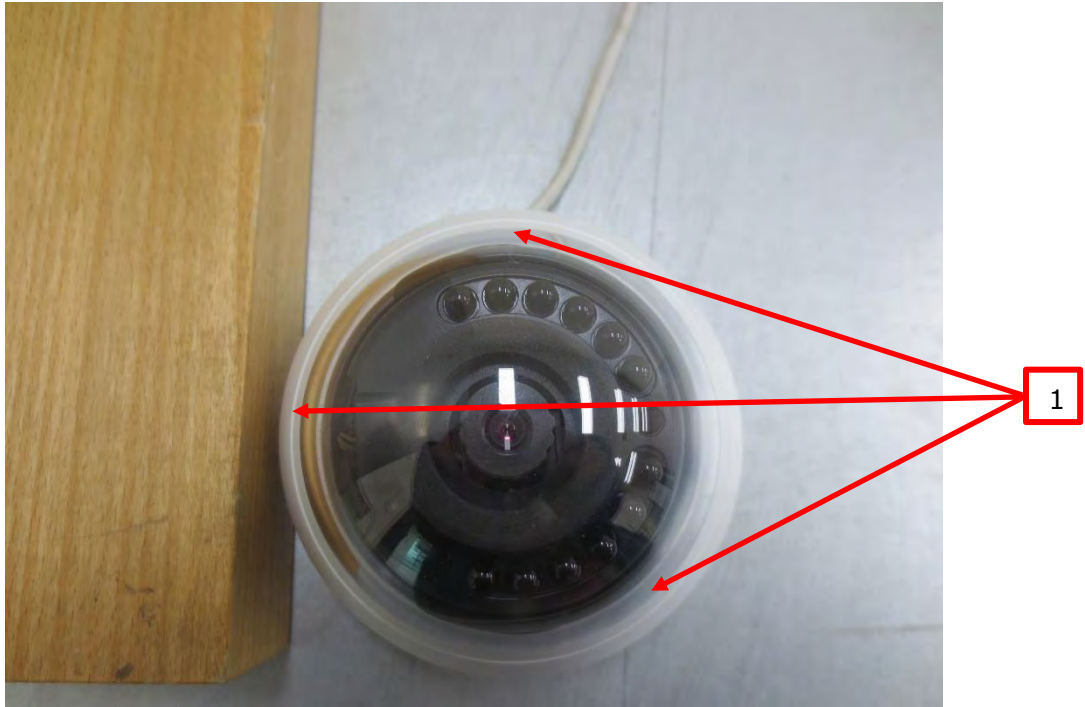
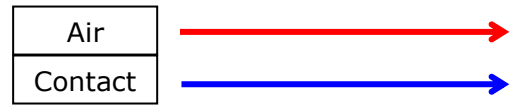

This report shall not be reproduced except in full, without the written approval of KES Co., Ltd.
The results shown in this test report refer only to the sample(s) tested unless otherwise stated.
The authenticity of the test report, contact shchoi@kes.co.kr



Test Data

Indirect Discharge

No.	Test Point	Discharge Method	Observations	Remarks
1	HCP Contact	Contact Discharge	Complied	-
2	VCP Contact	Contact Discharge	Complied	-

Direct Discharge

No.	Test Point	Discharge Method	Observations	Remarks
1	Enclosure	Air Discharge	Complied	-

Note: "Blank" = Not performed

Observations:
Complied – No degradation of function

Test Results

- PASS Required Performance Criteria
- NOT PASS Required Performance Criteria

Remarks

PASS Required Performance Criteria.

3.2 Radiated Electric Field Immunity

Reference Standard

EN 61000-4-3:2006 +A2:2010

Test Date

Dec. 29, 2017

Test Location

EMS-RS: SEMI ANECHOIC CHAMBER #2 SEMI ANECHOIC CHAMBER #3

Test Equipment

Used	Description	Model Number	Manufacturer	Serial Number	Cal. Due
<input checked="" type="checkbox"/>	EMS Test S/W	EMC32	R & S	10.10.02	-
<input checked="" type="checkbox"/>	SIGNAL GENERATOR	SMB 100A	R & S	177586	08, 07, 2018
<input checked="" type="checkbox"/>	BROADBAND AMPLIFIER	BBA100	R & S	101239	08, 07, 2018
<input checked="" type="checkbox"/>	BROADBAND AMPLIFIER	100S1G6M1	AR	579931	08, 07, 2018
<input checked="" type="checkbox"/>	POWER METER	NRP2	R & S	103475	08, 07, 2018
<input checked="" type="checkbox"/>	AVG POWER SENSOR	NRP-Z91	R & S	102526	08, 07, 2018
<input checked="" type="checkbox"/>	AVG POWER SENSOR	NRP-Z91	R & S	102527	08, 07, 2018
<input checked="" type="checkbox"/>	STACKED DOUBLE LOG-PER- ANTENNA	STPL9128 E	Schwarzbeck	9128ES-121	-
<input checked="" type="checkbox"/>	DIRECTIONAL COUPLER	KYDC-D1070-DX40	KY TELECOM	KY150001	08, 07, 2018
<input checked="" type="checkbox"/>	DOUBLE RIDGED HORN ANTENNA	SAS-571	A.H.SYSTEM, INC	781	05, 02, 2019

Test Conditions

Temperature: 21,7 °C
Relative Humidity: 42,0 % R.H.
Atmospheric Pressure: 100,8 kPa

This report shall not be reproduced except in full, without the written approval of KES Co., Ltd.
The results shown in this test report refer only to the sample(s) tested unless otherwise stated.
The authenticity of the test report, contact shchoi@kes.co.kr



Test Specifications

Antenna Polarization: Horizontal & vertical unless indicated otherwise

Antenna Distance: 3 m

Field Strength: 1 V/m 3 V/m
 10 V/m

Frequency Range: 80 MHz to 1 GHz 1,4 GHz to 2,7 GHz
 80 MHz to 2,7 GHz

Modulation: AM, 80 %, 1 kHz sine wave
 PM, 1 Hz (0,5 s ON : 0,5 s OFF)

Frequency step: 1 % step

Dwell Time: 1 s 3 s

of Sides Radiated: 4

Required Performance Criteria: Complied



KES Co., Ltd.

3701, 40, Simin-daero 365beon-gil,
Dongan-gu, Anyang-si, Gyeonggi-do, 14057, Korea
Tel: +82-31-425-6200 / Fax: +82-31-424-0450
www.kes.co.kr

Test report No.:
KES-E1-18T0032-R1
Page (26) of (60)

Test Data

Side Exposed	Observations	
	Horizontal	Vertical
Front	Complied	Complied
Right	Complied	Complied
Back	Complied	Complied
Left	Complied	Complied

Note: "Blank" = Not performed

Observations:
Complied – No degradation of function

Test Results

- PASS Required Performance Criteria
- NOT PASS Required Performance Criteria

Remarks

PASS Required Performance Criteria.

This report shall not be reproduced except in full, without the written approval of KES Co., Ltd.
The results shown in this test report refer only to the sample(s) tested unless otherwise stated.
The authenticity of the test report, contact shchoi@kes.co.kr

3.3 Electrical Fast Transients/Bursts

Reference Standard

EN 61000-4-4:2012

Test Date

Dec. 31, 2017

Test Location

EMS-EFT: Electro wave Shieldroom #7

Test Equipment

Used	Description	Model Number	Manufacturer	Serial Number	Cal. Due
<input checked="" type="checkbox"/>	EMS Test S/W	iec.control	EM TEST	5.4.7	-
<input checked="" type="checkbox"/>	ULTRA COMPACT SIMULATOR	UCS 500N7	EM TEST	P1608172950	11, 27, 2018
<input checked="" type="checkbox"/>	MOTOR VARIAC	MV2616	EM TEST	P1552169719	11, 27, 2018
<input checked="" type="checkbox"/>	CAPACITIVE COUPLING CLAMP	HFK	EM TEST	P1633183115	11, 27, 2018

Test Conditions

Temperature: 21,6 °C
Relative Humidity: 41,9 % R.H.
Atmospheric Pressure: 101,0 kPa

Test Specifications

Pulse Amplitude & Polarity: ± 1.0 kV ± 2.0 kV
(AC Power Lines) ± 4.0 kV

Pulse Amplitude & Polarity: ± 0.5 kV ± 1.0 kV
(Other supply / Signal Lines) ± 2.0 kV

Burst Period: 300 ms 2 s

Repetition Rate: 5 kHz 100 kHz

Duration of Test Voltage: ≥ 1 min

Required Performance Criteria: Complied

This report shall not be reproduced except in full, without the written approval of KES Co., Ltd.
The results shown in this test report refer only to the sample(s) tested unless otherwise stated.
The authenticity of the test report, contact shchoi@kes.co.kr

Test Data

Input a.c. power ports – Coupling/Decoupling Network used

Mode of Application	Observations	
	(+) Burst (kV)	(-) Burst (kV)
-	-	-

Input d.c. power ports – Coupling/Decoupling Network used

Mode of Application	Observations	
	(+) Burst (kV)	(-) Burst (kV)
-	-	-

Signal ports and telecommunication ports – Coupling Clamp used

Mode of Application	Observations	
	(+) Burst (kV)	(-) Burst (kV)
RJ-45 (Camera)	Complied	Complied

Note: “Blank” = Not performed
 Observations:
 Complied – No degradation of function

Test Results

- PASS Required Performance Criteria
- NOT PASS Required Performance Criteria

Remarks

PASS Required Performance Criteria.



3.4 Surge Transients

Reference Standard

EN 61000-4-5:2014

Test Date

N/A

Test Location

EMS-Surge: Electro wave Shieldroom

Test Equipment

Used	Description	Model Number	Manufacturer	Serial Number	Cal. Due
<input type="checkbox"/>	EMS Test S/W	iec.control	EM TEST	5.4.7	-
<input type="checkbox"/>	ULTRA COMPACT SIMULATOR	UCS 500N7	EM TEST	P1608172950	11, 27, 2018
<input type="checkbox"/>	MOTOR VARIAC	MV2616	EM TEST	P1552169719	11, 27, 2018
<input type="checkbox"/>	CDN	CNV 508N1	EM TEST	P1610176296	11, 28, 2018
<input type="checkbox"/>	CDN	CNV 504N7.3	EM TEST	P1744207079	12, 18, 2018

Test Conditions

Temperature:

°C

Relative Humidity:

% R.H.

Atmospheric Pressure:

kPa



Test Specifications

AC Power Lines

Source Impedance: 12 ohm for common Mode and 2 ohm for differential Mode

Surge Amplitude : Common Mode
 (0,5 / 1,0 / 2,0) kV
Differential Mode
 (0,5 / 1,0) kV

Number of Surges: 5 surges per angle

Angle: 0°, 90°, 180°, 270° (input a.c. power port)

Polarity: Positive & Negative

Repetition Rate: 1 surge per min 1 surge per 30 sec.

Required Performance Criteria: Complied

Other supply / Signal Lines

Source Impedance: 42 ohm for common Mode

Surge Amplitude: Common Mode
 (0,5 / 1,0) kV

Number of Surges: 5 Surges

Polarity: Positive & Negative

Repetition Rate: 1 surge per min 1 surge per 30 sec.

Required Performance Criteria: Complied



Test Data

Line to Earth – Common Mode

Mode of Application	Observations	
	(+) Surge (kV)	(-) Surge (kV)
-	-	-

Signal Lines

Line to Earth – Common Mode

Mode of Application	Observations	
	(+) Surge (kV)	(-) Surge (kV)
-	-	-

Note: "Blank" = Not performed

Observations:

Complied – No degradation of function

Test Results

- PASS Required Performance Criteria
- NOT PASS Required Performance Criteria

Remarks

N/A

3.5 Conducted Disturbance

Reference Standard

EN 61000-4-6:2014

Test Date

Dec. 27, 2017

Test Location

EMS-CS: Electro wave Shieldroom #6

Test Equipment

Used	Description	Model Number	Manufacturer	Serial Number	Cal. Due
<input checked="" type="checkbox"/>	EMS Test S/W	icd.control	EM TEST	5.3.11	-
<input checked="" type="checkbox"/>	CONTINUOUS WAVE SIMULATOR	CWS 500N1.4	EM TEST	P1602169880	11, 27, 2018
<input checked="" type="checkbox"/>	ATTENUATOR	ATT 6/80	EM TEST	P1614178148	11, 27, 2018
<input checked="" type="checkbox"/>	CDN	CDN M016	TESEQ	43694	11, 27, 2018
<input type="checkbox"/>	CDN	CDN M016	TESEQ	43697	11, 27, 2018
<input checked="" type="checkbox"/>	CDN	CDN T800	TESEQ	42800	11, 27, 2018
<input type="checkbox"/>	EM CLAMP	KEMZ 801A	TESEQ	44099	11, 28, 2018

Test Conditions

Temperature: 22,0 °C
Relative Humidity: 41,2 % R.H.
Atmospheric Pressure: 100,0 kPa

Test Specifications

Frequency range: 150 kHz to 100 MHz 150 kHz to 80 MHz

Voltage Level: 1 Vrms 3 Vrms
 10 Vrms

Modulation: AM, 80 %, 1 kHz sine wave
 PM, 1 Hz (0,5 s ON : 0,5 s OFF)

Frequency step: 1 % step

Dwell Time: 1 s 3 s

Required Performance Criteria: Complied

This report shall not be reproduced except in full, without the written approval of KES Co., Ltd.
The results shown in this test report refer only to the sample(s) tested unless otherwise stated.
The authenticity of the test report, contact shchoi@kes.co.kr



Test Data

Input a.c. power ports

Coupling Location (Line Stressed)	Coupling Method	Observations
-	CDN (<input type="checkbox"/> M2, <input type="checkbox"/> M3)	-

Input d.c. power ports

Coupling Location (Line Stressed)	Coupling Method	Observations
-	CDN (<input type="checkbox"/> M2, <input type="checkbox"/> M3)	-

Signal ports and telecommunication ports

Coupling Location (Line Stressed)	Coupling Method	Observations
RJ-45 (Camera)	CDN T800	Complied

Notes: CDN = Coupling Decoupling Network
"blank" = Not performed

Observations:
Complied – No degradation of function

Test Results

- PASS Required Performance Criteria
- NOT PASS Required Performance Criteria

Remarks

PASS Required Performance Criteria.



3.6 Voltage Dips and Short Interruptions

Reference Standard

EN 61000-4-11:2004

Test Date

N/A

Test Location

EMS-Voltage dip: Electro wave Shieldroom

Test Equipment

Used	Description	Model Number	Manufacturer	Serial Number	Cal. Due
<input type="checkbox"/>	EMS Test S/W	iec.control	EM TEST	5.4.7	-
<input type="checkbox"/>	ULTRA COMPACT SIMULATOR	UCS 500N7	EM TEST	P1608172950	11, 27, 2018
<input type="checkbox"/>	MOTOR VARIAC	MV2616	EM TEST	P1552169719	11, 27, 2018

Test Conditions

Temperature:

°C

Relative Humidity:

% R.H.

Atmospheric Pressure:

kPa



Test Specifications & Observations/Remarks

(Test Voltage : V)

<u>Test Level</u>	<u>Duration [in period/ms (50 Hz)]</u>	<u>Results</u>
<input type="checkbox"/> 20 % dip	<input type="checkbox"/> 250 / 5 000	-
<input type="checkbox"/> 30 % dip	<input type="checkbox"/> 25 / 500	-
<input type="checkbox"/> 60 % dip	<input type="checkbox"/> 10 / 200	-
<input type="checkbox"/> 100 % dip	<input type="checkbox"/> 250 / 5 000	-

- Voltage variations

<input type="checkbox"/> Unom + 10 %	<input type="checkbox"/> 253.0 V (ac)	-
<input type="checkbox"/> Unom - 15 %	<input type="checkbox"/> 195.5 V (ac)	-

Observations:

Complied – No degradation of function

Test Results

- PASS Required Performance Criteria
- NOT PASS Required Performance Criteria
- NOT APPLICABLE

Remarks

N/A



KES Co., Ltd.

3701, 40, Simin-daero 365beon-gil,
Dongan-gu, Anyang-si, Gyeonggi-do, 14057, Korea
Tel: +82-31-425-6200 / Fax: +82-31-424-0450
www.kes.co.kr

Test report No.:
KES-E1-18T0032-R1
Page (36) of (60)

APPENDIX A – TEST DATA

Conducted Emissions at Mains Power Ports

[HOT]

N/A

This report shall not be reproduced except in full, without the written approval of KES Co., Ltd.
The results shown in this test report refer only to the sample(s) tested unless otherwise stated.
The authenticity of the test report, contact shchoi@kes.co.kr



KES Co., Ltd.

3701, 40, Simin-daero 365beon-gil,
Dongan-gu, Anyang-si, Gyeonggi-do, 14057, Korea
Tel: +82-31-425-6200 / Fax: +82-31-424-0450
www.kes.co.kr

Test report No.:
KES-E1-18T0032-R1
Page (37) of (60)

[NEUTRAL]

N/A

◆ Calculation

QuasiPeak[dBuV] / CAverage [dBuV] = Reading Value[dBuV] + Corr. [dB]

QuasiPeak / CAverage : The Final Value

Reading Value : Not shown in the table.

Corr. : Correction values (LISN FACTOR + (Cable Loss + Pulse Limiter FACTOR))

This report shall not be reproduced except in full, without the written approval of KES Co., Ltd.
The results shown in this test report refer only to the sample(s) tested unless otherwise stated.
The authenticity of the test report, contact shchoi@kes.co.kr

Conducted Emissions at Telecommunication Ports

[10 Mbps]

Common Information

Test Description:	Telecommunication Emission
Model No.:	LND-6030RP
Mode	10 Mbps
Operator Name:	KES

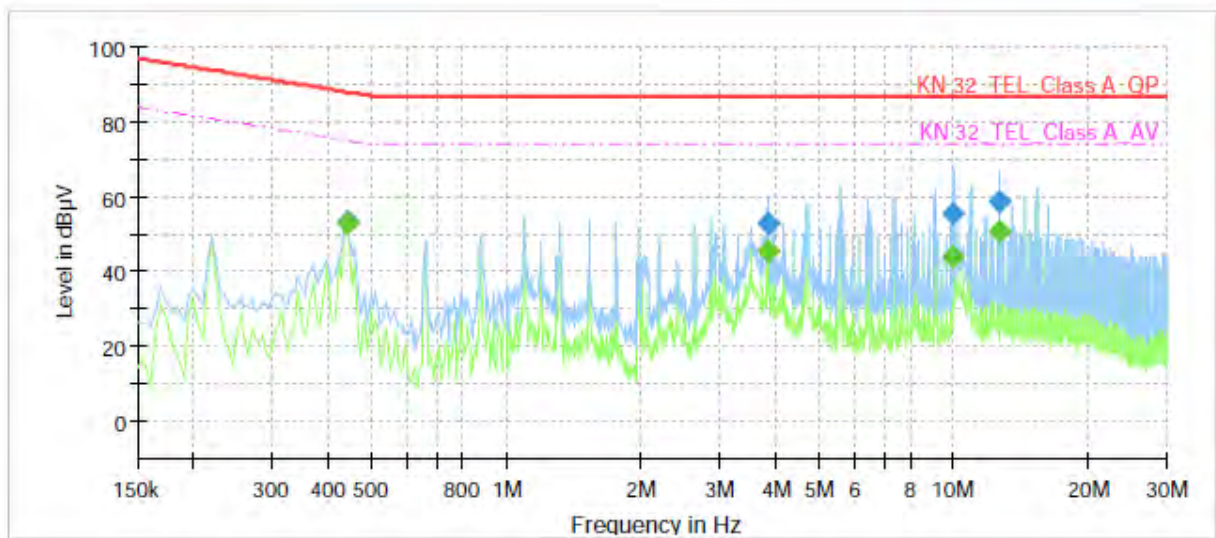

Final Result

Frequency (MHz)	QuasiPeak (dBµV)	CAverage (dBµV)	Limit (dBµV)	Margin (dB)	Meas. Time (ms)	Bandwidth (kHz)	Line	Corr. (dB)
0.440000	---	53.09	75.06	21.97	1000.0	9.000	Single Line	19.9
0.440000	53.66	---	88.06	34.40	1000.0	9.000	Single Line	19.9
3.860000	---	45.79	74.00	28.21	1000.0	9.000	Single Line	20.0
3.860000	52.80	---	87.00	34.20	1000.0	9.000	Single Line	20.0
10.005000	---	43.95	74.00	30.05	1000.0	9.000	Single Line	20.1
10.005000	55.78	---	87.00	31.22	1000.0	9.000	Single Line	20.1
12.660000	---	50.75	74.00	23.25	1000.0	9.000	Single Line	20.2
12.660000	59.00	---	87.00	28.00	1000.0	9.000	Single Line	20.2

This report shall not be reproduced except in full, without the written approval of KES Co., Ltd.
 The results shown in this test report refer only to the sample(s) tested unless otherwise stated.
 The authenticity of the test report, contact shchoi@kes.co.kr

[100 Mbps]

Common Information

Test Description:	Telecommunication Emission
Model No.:	LND-6030RP
Mode	100 Mbps
Operator Name:	KES

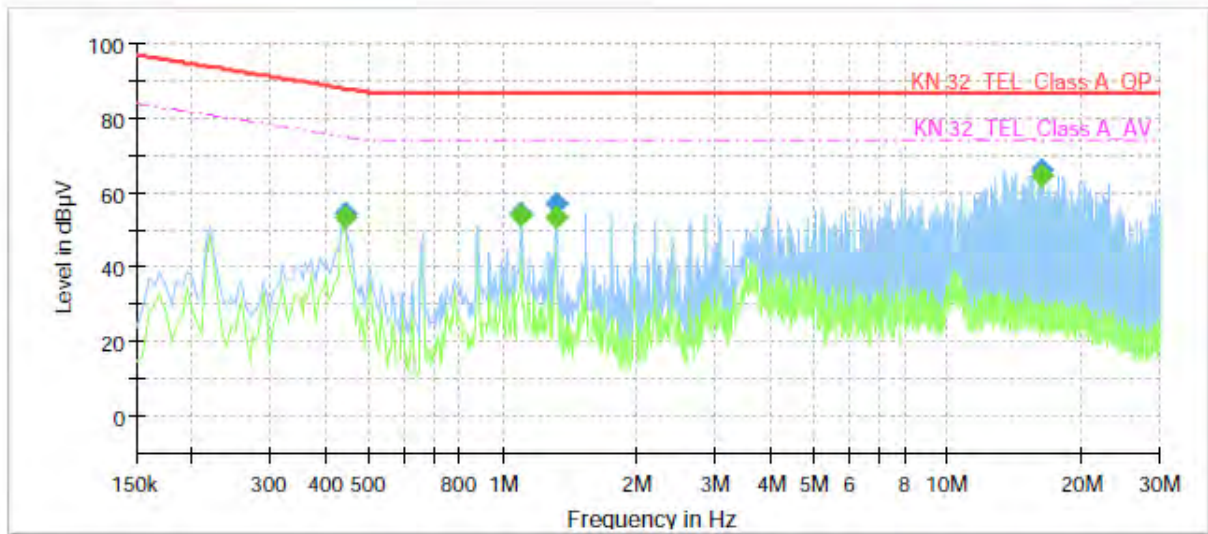

Final Result

Frequency (MHz)	QuasiPeak (dBµV)	CAverage (dBµV)	Limit (dBµV)	Margin (dB)	Meas. Time (ms)	Bandwidth (kHz)	Line	Corr. (dB)
0.440000	---	53.35	75.06	21.71	1000.0	9.000	Single Line	19.9
0.440000	54.27	---	88.06	33.79	1000.0	9.000	Single Line	19.9
1.100000	---	53.76	74.00	20.24	1000.0	9.000	Single Line	20.2
1.100000	54.41	---	87.00	32.59	1000.0	9.000	Single Line	20.2
1.320000	---	53.23	74.00	20.77	1000.0	9.000	Single Line	20.2
1.320000	57.40	---	87.00	29.60	1000.0	9.000	Single Line	20.2
16.230000	---	64.56	74.00	9.44	1000.0	9.000	Single Line	20.2
16.230000	66.35	---	87.00	20.65	1000.0	9.000	Single Line	20.2

◆ Calculation

QuasiPeak [dBuV] / CAverage [dBuV] = Reading Value [dBuV] + Corr. [dB]

QuasiPeak / CAverage : The Final Value

Reading Value : Not shown in the table.

Corr. : Correction values (ISN FACTOR + (Cable Loss + Pulse Limiter FACTOR))

Radiated Electric Field Emissions(Below 1 GHz)

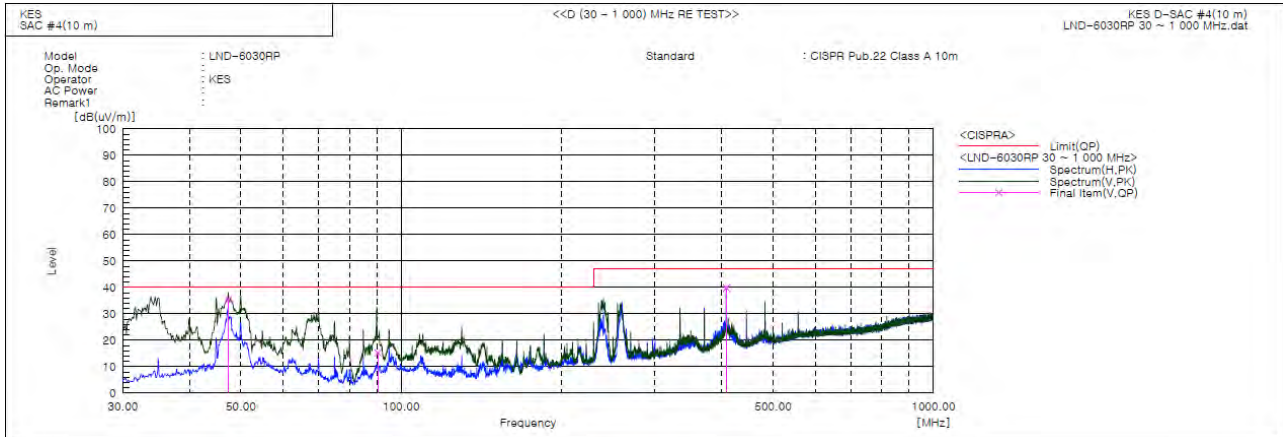

Final Result

No.	Frequency [MHz]	(P)	Reading QP [dB(uV)]	c.f [dB(1/m)]	Result QP [dB(uV/m)]	Limit QP [dB(uV/m)]	Margin QP [dB]	Height [cm]	Angle [deg]	Remark
1	47.392	V	63.4	-27.9	35.5	40.0	4.5	245.0	350.0	
2	90.427	V	45.6	-30.4	15.2	40.0	24.8	359.0	156.0	
3	408.350	V	60.0	-20.2	39.8	47.0	7.2	110.0	24.0	

◆ Calculation – SEMI ANECHOIC CHAMBER #4(10 m)

Result(QP) [dB(μV/m)] = (Reading(QP) [dB(μV)] + c.f [dB(1/m)])

Margin(QP) [dB] = Limit[dB(μV/m)] - Result(QP) [dB(μV/m)]

Reading(QP) : Reading value, Result(QP) : Reading value + Factor value

Limit(QP) : Limit value, c.f : (ANT Factor + Cable Loss - Preamp Factor), Margin: Margin value



Radiated Electric Field Emissions(Above 1 GHz)

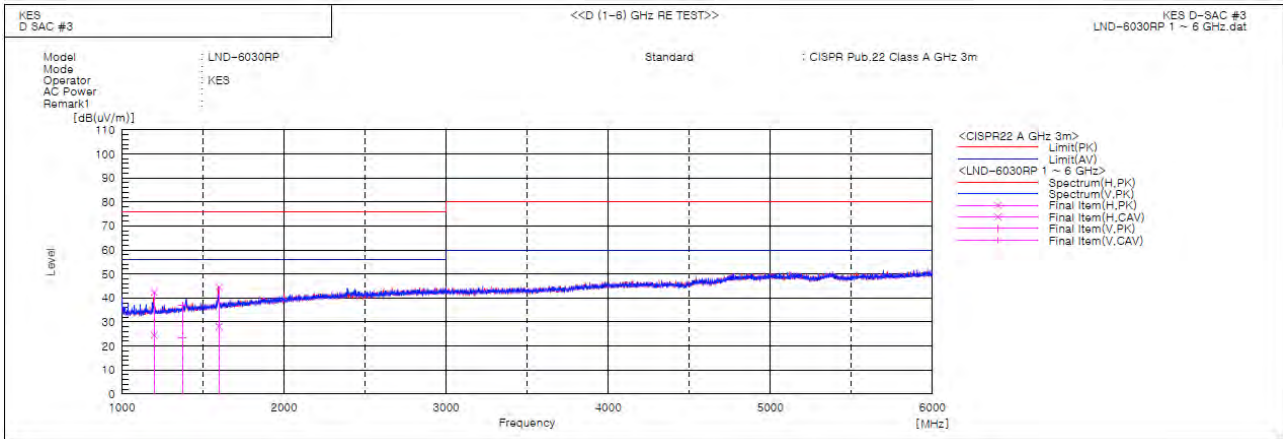

Final Result

No.	Frequency [MHz]	(P)	Reading PK [dB(uV)]	Reading CAV [dB(uV)]	c.f [dB(1/m)]	Result PK [dB(uV/m)]	Result CAV [dB(uV/m)]	Limit PK [dB(uV/m)]	Limit AV [dB(uV/m)]	Margin PK [dB]	Margin CAV [dB]	Height [cm]	Angle [deg]	Remark
1	1199.649	H	50.8	32.9	-8.5	42.3	24.4	76.0	56.0	33.7	31.6	100.0	4.6	
2	1372.974	V	44.0	30.7	-7.2	36.8	23.5	76.0	56.0	39.2	32.5	100.0	9.8	
3	1600.209	H	49.7	33.3	-5.2	44.5	28.1	76.0	56.0	31.5	27.9	100.0	295.8	

◆ Calculation

$$\text{Result(PK/CAV)} \text{ [dB(}\mu\text{V/m)}] = (\text{Reading(PK/CAV)} \text{ [dB(}\mu\text{V)}] + \text{c.f [dB(1/m)}])$$

$$\text{Margin(PK/CAV)} \text{ [dB]} = \text{Limit [dB(}\mu\text{V/m)}] - \text{Result(PK/CAV)} \text{ [dB(}\mu\text{V/m)}]$$

Reading(PK/CAV) : Reading value, Result(PK/CAV) : Reading value + Factor value

Limit(QP) : Limit value, c.f : (ANT Factor + Cable Loss - Preamp Factor), Margin: Margin value

This report shall not be reproduced except in full, without the written approval of KES Co., Ltd.
 The results shown in this test report refer only to the sample(s) tested unless otherwise stated.
 The authenticity of the test report, contact shchoi@kes.co.kr



Harmonic Current Emissions and Voltage Fluctuations and Flicker

Average harmonic current results				
Hn	I _{eff} [A]	% of Limit	Limit [A]	Result
N/A				

Harmonic currents less than 0.6% of the input current measured under the test conditions, or less than 5 mA, whichever is greater, are disregarded.

This report shall not be reproduced except in full, without the written approval of KES Co., Ltd.
The results shown in this test report refer only to the sample(s) tested unless otherwise stated.
The authenticity of the test report, contact shchoi@kes.co.kr



Test Data - Harmonics (continued)

Maximum harmonic current results

Hn	I _{eff} [A]	% of Limit	Limit [A]	Result
N/A				

Harmonic currents less than 0.6% of the input current measured under the test conditions, or less than 5 mA, whichever is greater, are disregarded.

This report shall not be reproduced except in full, without the written approval of KES Co., Ltd.
The results shown in this test report refer only to the sample(s) tested unless otherwise stated.
The authenticity of the test report, contact shchoi@kes.co.kr



Test Data - Voltage Fluctuations

Maximum Flicker results

	EUT values	Limit	Result
Pst	N/A		
Plt			
dc [%]			
dmax [%]			
Tmax [s]			

This report shall not be reproduced except in full, without the written approval of KES Co., Ltd.
The results shown in this test report refer only to the sample(s) tested unless otherwise stated.
The authenticity of the test report, contact shchoi@kes.co.kr



KES Co., Ltd.

3701, 40, Simin-daero 365beon-gil,
Dongan-gu, Anyang-si, Gyeonggi-do, 14057, Korea
Tel: +82-31-425-6200 / Fax: +82-31-424-0450
www.kes.co.kr

Test report No.:
KES-E1-18T0032-R1
Page (45) of (60)

Test Setup Photos and Configuration

Conducted Voltage Emissions

N/A

N/A

This report shall not be reproduced except in full, without the written approval of KES Co., Ltd.
The results shown in this test report refer only to the sample(s) tested unless otherwise stated.
The authenticity of the test report, contact shchoi@kes.co.kr

Conducted Telecommunication Emissions

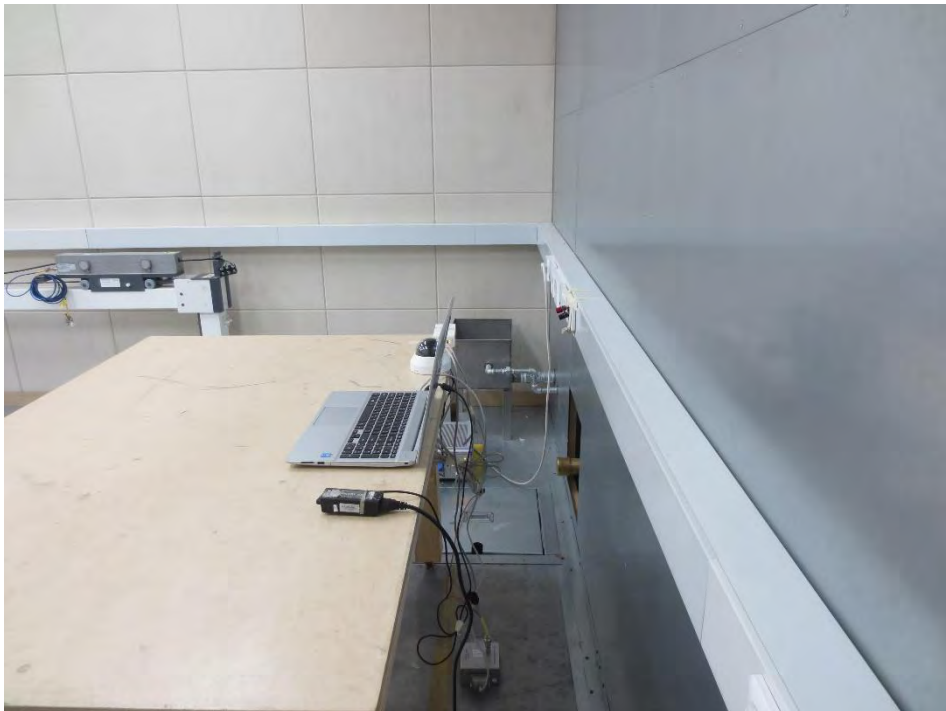

This report shall not be reproduced except in full, without the written approval of KES Co., Ltd.
The results shown in this test report refer only to the sample(s) tested unless otherwise stated.
The authenticity of the test report, contact shchoi@kes.co.kr

Radiated Electric Field Emissions(Below 1 GHz)

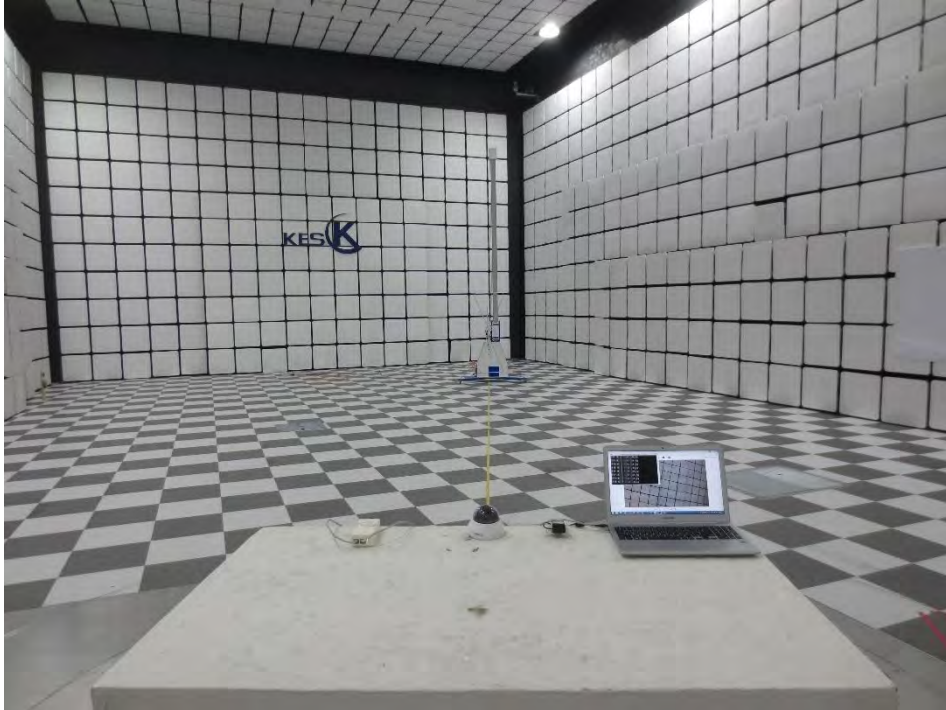

This report shall not be reproduced except in full, without the written approval of KES Co., Ltd.
The results shown in this test report refer only to the sample(s) tested unless otherwise stated.
The authenticity of the test report, contact shchoi@kes.co.kr

Radiated Electric Field Emissions(Above 1 GHz)

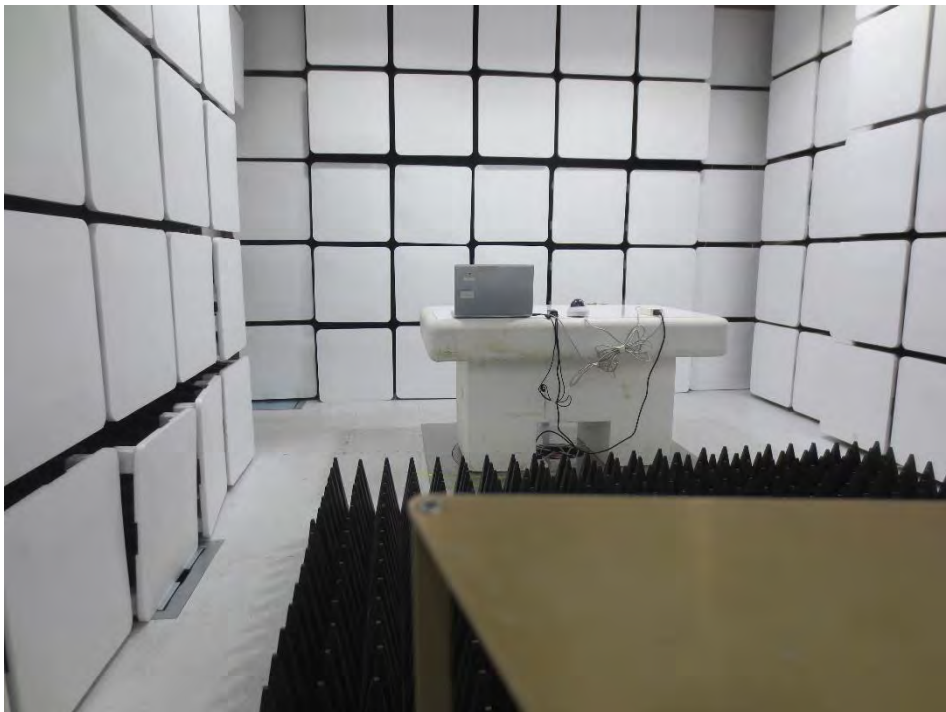

This report shall not be reproduced except in full, without the written approval of KES Co., Ltd.
The results shown in this test report refer only to the sample(s) tested unless otherwise stated.
The authenticity of the test report, contact shchoi@kes.co.kr



KES Co., Ltd.

3701, 40, Simin-daero 365beon-gil,
Dongan-gu, Anyang-si, Gyeonggi-do, 14057, Korea
Tel: +82-31-425-6200 / Fax: +82-31-424-0450
www.kes.co.kr

Test report No.:
KES-E1-18T0032-R1
Page (49) of (60)

Harmonic Current Emissions and Voltage Fluctuations and Flicker

N/A

This report shall not be reproduced except in full, without the written approval of KES Co., Ltd.
The results shown in this test report refer only to the sample(s) tested unless otherwise stated.
The authenticity of the test report, contact shchoi@kes.co.kr

Electrostatic Discharge



Radiated Electric Field Immunity



This report shall not be reproduced except in full, without the written approval of KES Co., Ltd.
The results shown in this test report refer only to the sample(s) tested unless otherwise stated.
The authenticity of the test report, contact shchoi@kes.co.kr

Electrical Fast Transients/Bursts



This report shall not be reproduced except in full, without the written approval of KES Co., Ltd.
The results shown in this test report refer only to the sample(s) tested unless otherwise stated.
The authenticity of the test report, contact shchoi@kes.co.kr



KES Co., Ltd.

3701, 40, Simin-daero 365beon-gil,
Dongan-gu, Anyang-si, Gyeonggi-do, 14057, Korea
Tel: +82-31-425-6200 / Fax: +82-31-424-0450
www.kes.co.kr

Test report No.:
KES-E1-18T0032-R1
Page (52) of (60)

Surge Transients

N/A

This report shall not be reproduced except in full, without the written approval of KES Co., Ltd.
The results shown in this test report refer only to the sample(s) tested unless otherwise stated.
The authenticity of the test report, contact shchoi@kes.co.kr

Conducted Disturbance



This report shall not be reproduced except in full, without the written approval of KES Co., Ltd.
The results shown in this test report refer only to the sample(s) tested unless otherwise stated.
The authenticity of the test report, contact shchoi@kes.co.kr



KES Co., Ltd.

3701, 40, Simin-daero 365beon-gil,
Dongan-gu, Anyang-si, Gyeonggi-do, 14057, Korea
Tel: +82-31-425-6200 / Fax: +82-31-424-0450
www.kes.co.kr

Test report No.:
KES-E1-18T0032-R1
Page (54) of (60)

Voltage Dips and Short Interruptions

N/A

This report shall not be reproduced except in full, without the written approval of KES Co., Ltd.
The results shown in this test report refer only to the sample(s) tested unless otherwise stated.
The authenticity of the test report, contact shchoi@kes.co.kr

EUT External Photographs

(Top)



(Bottom)



This report shall not be reproduced except in full, without the written approval of KES Co., Ltd.
The results shown in this test report refer only to the sample(s) tested unless otherwise stated.
The authenticity of the test report, contact shchoi@kes.co.kr

EUT Internal Photographs

(Internal View)



This report shall not be reproduced except in full, without the written approval of KES Co., Ltd.
The results shown in this test report refer only to the sample(s) tested unless otherwise stated.

EUT Internal View – Main board

(Top)



(Bottom)



This report shall not be reproduced except in full, without the written approval of KES Co., Ltd.
The results shown in this test report refer only to the sample(s) tested unless otherwise stated.

EUT Internal View – Subr board 1

(Top)



(Bottom)



This report shall not be reproduced except in full, without the written approval of KES Co., Ltd.
The results shown in this test report refer only to the sample(s) tested unless otherwise stated.

EUT Internal View – Sub board 2

(Top)

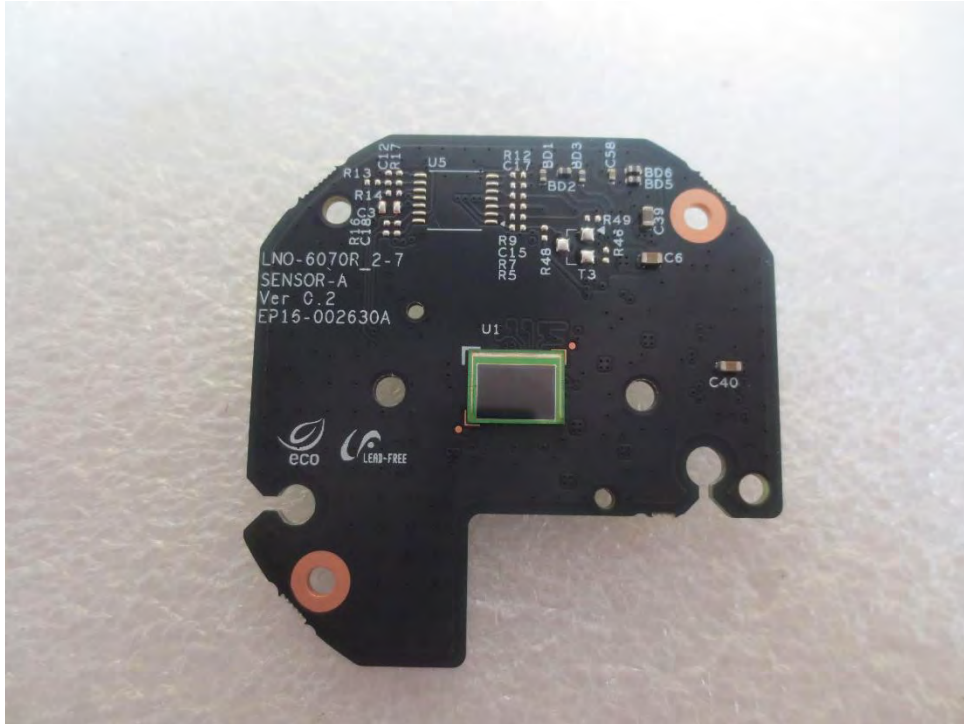

(Bottom)

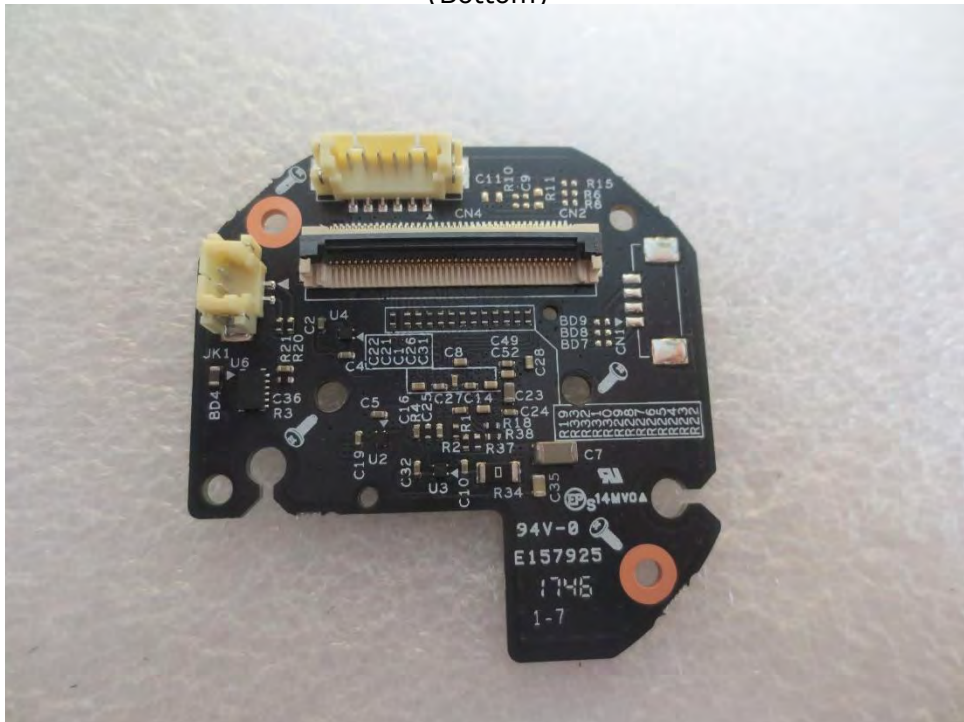

This report shall not be reproduced except in full, without the written approval of KES Co., Ltd.
 The results shown in this test report refer only to the sample(s) tested unless otherwise stated.

Label and Location

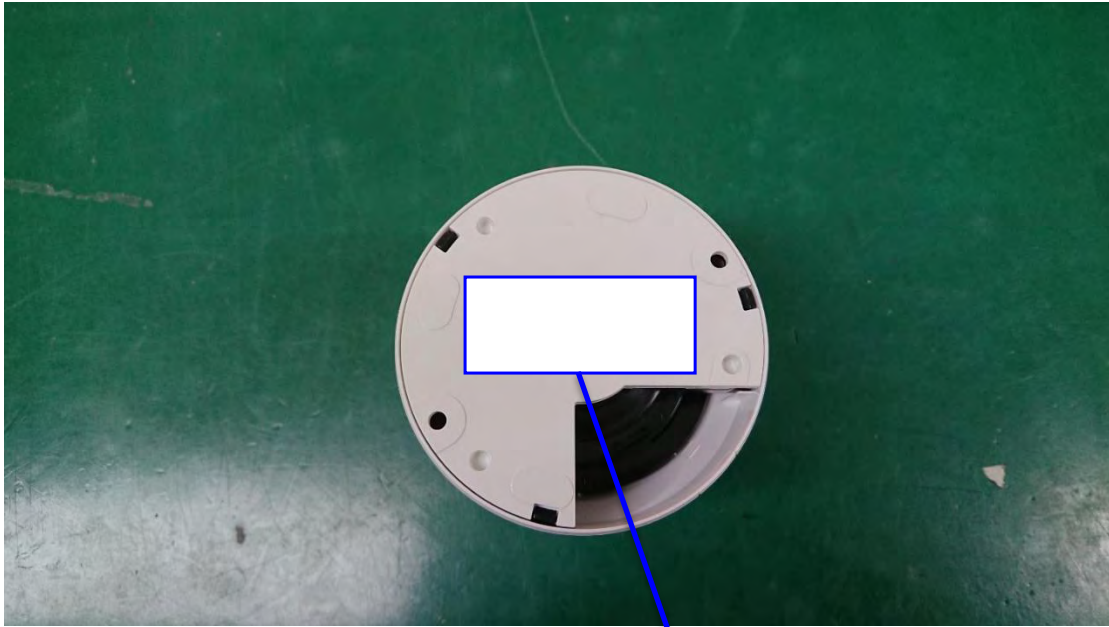

Network Camera

Model No : LND-6030R

Manufacturer : Hanwha Techwin (Tianjin) Co.,Ltd.

Made in China

